

# WIRELESS GIANT OF THE PACIFIC

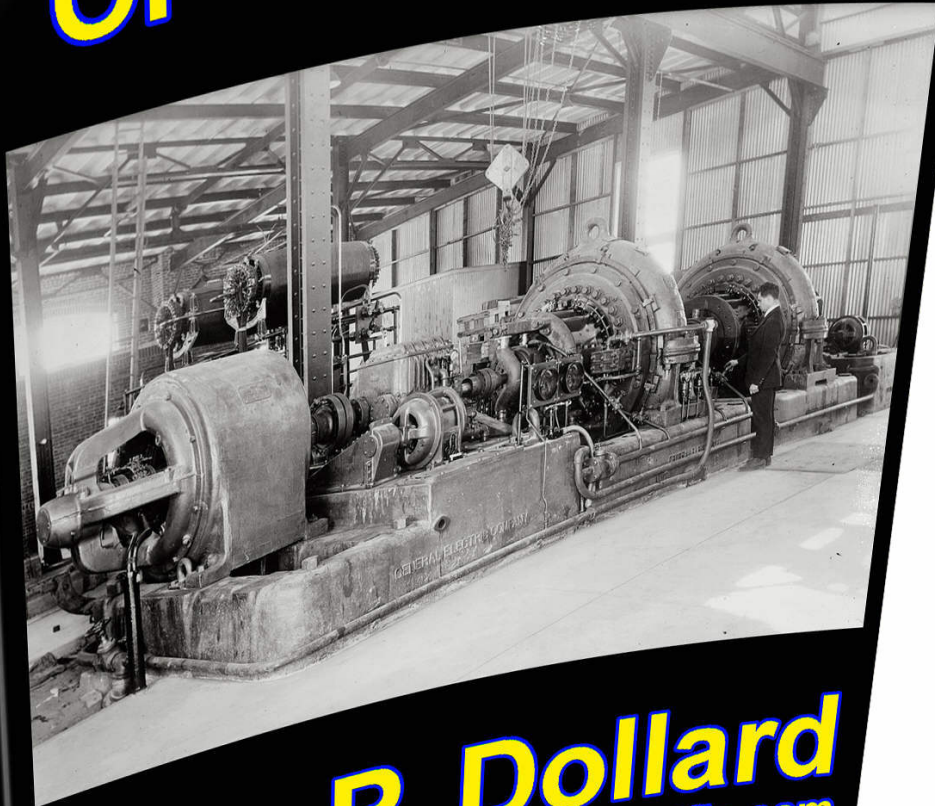

**Eric P. Dollard**

[www.wirelessgiantofthepacific.com](http://www.wirelessgiantofthepacific.com)

[www.wirelessgiantofthepacific.com](http://www.wirelessgiantofthepacific.com)  
**Eric P. Dollard**



# Wireless Giant of the Pacific

Written and Compiled by

Eric P. Dollard

Published by  
A&P Electronic Media  
Liberty Lake, Washington

Cover Layout: Aaron Murakami  
Book Layout Peter Lindemann  
A&P Electronic Media  
Liberty Lake, Washington

Front Cover 3D Graphic: Aaron Murakami  
Interior Images by: Various Sources

**Copyright © 2013 Eric P. Dollard (Author, copyright for content)**  
**Copyright © 2013 A&P Electronic Media (Publisher, copyright for layout)**

All Rights Reserved, Worldwide. No part of this publication may be reproduced, stored in an electronic retrieval system, or transmitted in any form, or by any means, without the prior, written permission of the copyright holders or the publisher. Unauthorized copying of this digital file is a criminal offense and prohibited by International Law.

Digital Edition Published by: A&P Electronic Media  
PO Box 713  
Liberty Lake, WA 99019  
<http://emediapress.com/>

Book Version 1.00 - Release Date: September, 2013

**First Edition:**

First Printing: September, 2013  
Digital Format: PDF File  
50,000 Authorized Downloads



# Editor's Note and Disclaimer

The author of this work is 100% responsible for its content. Most of the material presented here has been used as "camera ready" images as they were submitted by the author. When retyped, they have only been edited to the extent considered necessary for clarity. Therefore, the material is not entirely formatted as a new publication. It is presented as a collection of historic documents punctuated by the author's commentary, as well as the reproduction of a huge collection of the author's original, mathematical and technical analysis, as it was originally written in his research notebooks.

The views and opinions expressed in this book are those of the author and do not necessarily reflect the views, opinions, or legal position of the editor or publisher. Some of the material presented here is controversial, and suggests misconduct by certain parties against the author and the historic site at Bolinas, California. We believe that the material that supports each party's position is of sufficient clarity for the reader to make up their own mind concerning their veracity.

Our interest in publishing this material is related specifically to the historic relevance of the technical information and its relationship to the history of wireless communications technology and the development of commercial and military radio in its first 50 years. We also recognize that large corporations are in the business of "making money" and that in that pursuit, the technologies utilized can change in value over time. These fluctuations of "perceived value" by the various parties, concerning the site at Bolinas, California, are certainly well documented in this material.

The author's technical evaluation of how these early "wireless" transmitters worked and upon whose patents they were based is a unique historic perspective that deserves publication. This has been our sole interest in being involved with the project.

If there is sufficient interest, a fully formatted presentation of this material could be developed at some point in the future.

A&P Electronic Media

## *Dedication:*

This book is dedicated to the remarkable crew of the Bolinas Radio Transmission Facility;

Chief Engineer:	Frank Spicer
Manager:	Gus Kouats
Technician/Machinist:	Ivan Neilson
Chief Rigger:	Jim Bourne

These individuals created the legend of KET-KPH at Bolinas, California. Also to be noted are the efforts of District Vice-President Jim Hepburn, who facilitated the transfer of out-dated equipment to scientific endeavors, leading to the writing of this manuscript.

Eric P. Dollard



# *Preface*

1) The following paper serves as a companion to the recent historic resource study of the Bolinas Radio Transmission Facility, this study being undertaken by the U.S. Department of the Interior, National Park Service (N.P.S.), Point Reyes National Sea Shore. This N.P.S. study is quite exhaustive in its representation of station history and will become the standard handbook. The N.P.S. study quite naturally omits the theoretical and engineering details of the Bolinas site, and limited funding prevented any detailed analysis of artifacts and edifices that surround the station buildings. Therefore, such is the principle undertaking of this paper.

Further omitted by the N.P. S. study are the historical details surrounding the development and implementation of the early wireless systems utilized at Bolinas. This is understandable since such details have systematically vanished from historical references on the subject. This paper takes an engineer's walk through wireless history, pointing to where its principles would originate.

Finally, the N.P.S. study neglects the examination of factors which led to the Bolinas Facility being almost completely destroyed, despite ample effort to protect it. Now the station is on the brink of extermination. Such factors are those of politics, finding no place in a study such as that of the N.P.S. However, in the course of historic study it is clearly seen that politicians and corporate magnates gave us the radio of today, a radio that strayed far off course from the aims of those who conceived it. These factors would have the Bolinas site silent for now and evermore.

2) It has been said by radio historian Jerry Vassillatos that a walk through radio history is stranger than fiction. Tracing the steps of development, one meets the most enigmatic scientist of modern history, Nikola Tesla. Also, it is a strange irony that the family of Philo Taylor Farnsworth resided within sight of the R.C.A. Bolinas Facility. This would place the Radio Corporation of America in a new light and provide a glimpse of 21<sup>st</sup> century electron tubes. In this study one begins to notice that the theory and practice of the electrostatic wireless, such as that of

Bolinas, seem to contradict the very foundations of modernistic physical science. Electrical forces are found to be very non-physical, but the emerging technology produced functioning systems that were engineerable. It is in the study of this pre-historic wireless and the individuals who conceived it that one sees the electrostatic technology of the 21<sup>st</sup> century in its primordial form. It is a wonder how the transformers of Tesla, capable of matching the forces of nature, or how the tubes of Farnsworth, creating suns and stars within their bulbs, could be so completely ignored. How could any study of energy or space not begin with these scientists and their contemporaries? For all their efforts, we still have the thermodynamic technology of the 19<sup>th</sup> century, a technology of the cave man and his fire.



# Table of Contents

Dedication . . . . .	Page 5
Preface . . . . .	Page 6
Table of Contents. . . . .	Page 8
Introduction. . . . .	Page 10

## *PART ONE* Page 13

The History of Electric Wireless and its Relation to  
the Bolinas, California Transmission Facility

<b>Chapter One</b> . . . . .	Page 13
The Bolinas Site	
<b>Chapter Two</b> . . . . .	Page 50
Marconi and His Wireless	
<b>Chapter Three</b> . . . . .	Page 90
The Radio Corporation of America	
<b>Chapter Four</b> . . . . .	Page 131
Dr. Alexanderson	
<b>Chapter Five</b> . . . . .	Page 152
The San Francisco Bay Area	
<b>Chapter Six</b> . . . . .	Page 167
Nikola Tesla	
<b>Chapter Seven</b> . . . . .	Page 186
The Commonwealth Question	

***PART TWO*** Page 222

Physical and Historical Reconstruction  
of the Electrostatic Wireless

Section 1)	Historical Sequence . . . . .	Page 223
Section 2)	The Initial Layout . . . . .	Page 224
Section 3)	Marconi Aerial Dimensions . . . . .	Page 226
Section 4)	Aerial Electric Dimensions . . . . .	Page 227
Section 5)	The Alexanderson Layout . . . . .	Page 229
Section 6)	Additional Structures . . . . .	Page 230
Section 7)	Ground Structure Details . . . . .	Page 231
Section 8)	First Section Compensator . . . . .	Page 232
Section 9)	Second Section Compensator . . . . .	Page 233
Section 10)	End or Third Section Compensator . . . . .	Page 234
Section 11)	Compensator Detail Input Section . . . . .	Page 235
Section 12)	Third Phase Development . . . . .	Page 236
Section 13)	Fourth Phase Development . . . . .	Page 237
Section 14)	Location of Artifacts . . . . .	Page 237
Section 15)	Photos, Illustrations, and Articles . . . . .	Page 238

***PART THREE*** Page 290

Alexanderson Aerial Electric Dimensions

Section 1)	Aerial Electric Constants . . . . .	Page 291
Section 2)	Supporting Illustrations . . . . .	Page 295
Section 3)	Experimental Scale Model . . . . .	Page 306

***APPENDICES*** Page 309

Appendix I	Experimental Networks . . . . .	Page 310
Appendix II	Complex Electric Theory . . . . .	Page 321
Appendix III	Historic Patents . . . . .	Page 340



# *Introduction*

1) The historic study of the Bolinas Radio Transmission site yields a wide range of knowledge relating not only to the development of modern electromagnetic radio, but also to the lesser known early electrostatic wireless. Modern radio was created beginning with the birth of R.C.A., through the years of World War II. Bolinas was to play its part in this development, utilizing the various innovations of R.C.A. Unique to Bolinas is its pre-historic era of electrostatic (electric) wireless, and its development from Marconi to Alexanderson.

2) The electric wireless period of the Bolinas was short, spanning about 10 years. It began with Marconi and his system in 1913. R.C.A.'s entry with the Alexanderson system extended to 1924, when shortwave rendered the electric wireless obsolete. By 1928 it was gone. The U.S. Navy took a renewed interest in 1940, constructing a limited version of the Alexanderson system. This served the submarine communication needs of the war. After the war the Navy removed their electric wireless and such was never again utilized by R.C.A. A new system has been proposed for the Bolinas site to replace the now obsolete shortwave operation. This system utilizes no aerial structure, just the remaining electric wireless ground plane. Its implementation is ultimately denied by the N.P.S. and The Commonwealth.

3) With Alexanderson and his effort to adapt the existing Marconi aerial of the Bolinas site, an aerial emerged that stands apart from all others erected there. This was to be known as the Alexanderson Multiple Tuned Aerial. While the Bolinas aerial was compact from the standpoint of the 15 kilometer wave it launched, it was physically and electrically massive. This aerial was about 3000 feet in length and 600 feet wide, standing 300 feet off the ground. An equivalent structure was buried beneath the aerial. The confined electrostatic field was over 120 million cubic feet with an electrical activity of over 20 million volt-amperes. It was a bottle of lightning. Twelve-foot high coils regulated the power flow, developing over one hundred thousand volts. The entire network glowed in a blue-violet light, flashing on and off with the Morse key like a giant neon sign.

4) Despite the enormity of the Bolinas Alexanderson Aerial and its remarkable history, record of it is absent. Only distant legends of now gone old-timers remain. Its blueprints once stood in the Marconi Hotel but vanished to the winds along with Marconi's name—regarded as worthless, obsolete junk. What remains of it are concrete anchors and foundations that once held the masts and coils. The position of these artifacts establish the overall geometry of the aerial. A considerable quantity of breakage remains from the demolition, mostly scattered along the ocean cliffs. Key elements have been located. Through analysis of this material, and childhood memories of blueprints, and verbal descriptions, a reconstruction of the Bolinas Alexanderson Aerial has been developed. Many unknowns still exist however, particularly with regard to the end section of the aerial. Recent information uncovered by the park service has helped greatly and the reconstruction should have a fair degree of accuracy. It is remarkable that the underground portion appears to be intact. This should not go unnoticed.

5) Before an historic study of the Bolinas site was undertaken by the National Park Service, the Alexanderson aerial had been considered a pre-historic curiosity, a dinosaur. This has been found to be a misconception. At the time of its development a schismatic condition existed among the theories and patents of their inventors. It was an all-out war, demanding government intervention. Further, the "electricians" of the time held opposing views with regard to those of the emerging atomic science. Upon examination of the aerial patents of Alexanderson, certain characteristics of scientific interest are noted. The ruins at Bolinas indicate the full embodiment of Alexanderson's concept, that is, an aerial with no wavelength and no electromagnetic waves. This is unthinkable in the minds of modern radio engineers, but it worked. From the theoretical standpoint it may be the ultimate radio antenna. How this would be missed is, the reception aerial was a simple structure, often just a long piece of wire. The cost was low. The reception aerials were never exact duplicates of their transmission counterparts. The full benefit of the concept thus would never be obtained.



6) It has gone down in history that the Alexanderson aerial is an archaic and ineffective electromagnetic radiator, and from that standpoint this is true. However, it is an instrument of the electric wireless and is worthy of further study because it is significant historically. As well, from the theoretical standpoint, two scale models are proposed for the Bolinas site and the National Park Service. The 160-meter (1800 kilocycle/second) amateur band has been chosen for the reasons of it making for a 100 to 1 scale; and the site presently holds amateur radio station license KD6OSX-AE. Such a model would be for testing purposes, standing a few feet off the ground and 30 feet in length. It would operate with the existing (M.C.I.) tuning coil shack with a power of 1500 watts. Upon determination of technical details and further historical examination, an historically accurate model would be constructed for 400 or 500 kilocycles/second. This would be made up of masts 15 feet high, and about 100 feet in length, with an interpretive plaque outlining its historical significance. This would serve the historic Bolinas site well.

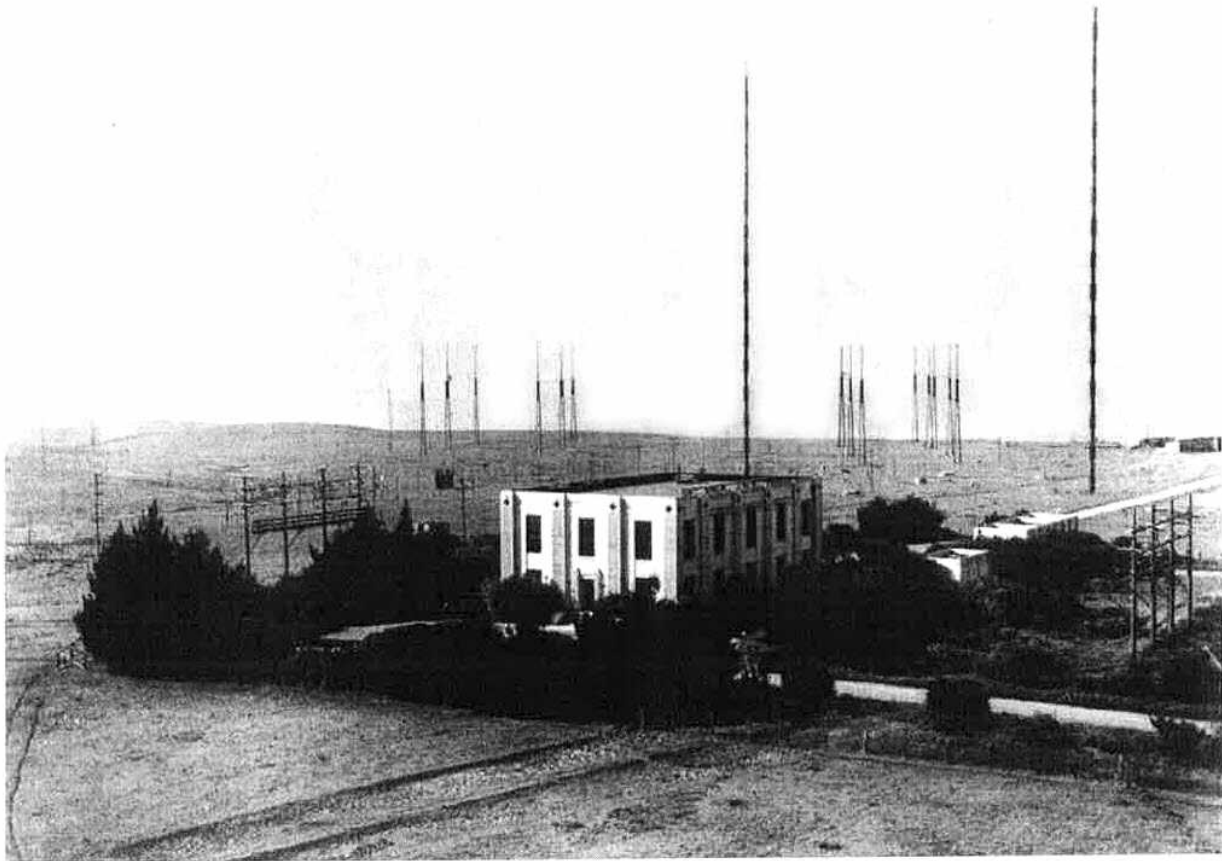

Early photo of Marconi Building 2 at the Bolinas Transmitter Site.

# ***PART ONE***

The History of Electric Wireless  
and its relation to  
the Bolinas, California Transmission Facility

## **Chapter One**

### **The Bolinas Site**

Author Commentary: pages 14 - 16

Historic Documents: pages 17 - 49

l) The Bolinas Site (fig. 1)

1) In the year of 1913, near the coastal town of Bolinas, California, the Marconi Wireless Telegraph Company of America began the construction of one of the world's larger wireless power stations. Bolinas was one of a series of stations that spanned the globe. The parent station was the New Brunswick, New Jersey facility. Station construction was carried out by the J.C. White Engineering Company, and components were made by the Wireless Specialty Apparatus Company. Bolinas was to receive a 300 Kilowatt disruptive discharge (spark) oscillator, one of the world's biggest. Bolinas would operate on 44.77 kilocycles per second as station KET. Guglielmo Marconi, age 39, had labored some 15 years toward this engineering and commercial endeavor. The parent station at New Brunswick was the leading edge of science at the time, representing a 60-year evolution in the theory and practice of electric wave telegraphy. Great minds such as Tesla, Steinmetz and Einstein were to be seen at the New Brunswick site. Bolinas was host to Marconi, Alexanderson and numerous lesser historic figures. The Bolinas station was to become one of Radio Corporation of America's first operational facilities in 1919, and was to see significant advancements in wireless, from its inception in 1913 until the shortwave era's beginning in 1924. Today wireless has become a forgotten chapter in electrical engineering.

2) The town of Bolinas, located 11 miles north of San Francisco, was a small fishing and lumber town with a small but busy port. It was noted for its rowdiness and numerous dogs. Today Bolinas is noted for its lawlessness and still, numerous dogs. In the 30s a San Francisco newspaper staged a promotional gimmick involving a land giveaway on the Bolinas Mesa. This resulted in sub-division into lots and Bolinas becoming a residential community. Today's population is estimated at 1500.

3) Bolinas sits at the mouth of a large lagoon named after the town. The site chosen by Marconi overlooks the Pacific Ocean about three miles northwest of the town. ~~The powerhouse sits west of the town.~~ The powerhouse sits about 90 feet above sea level adjacent to eroding coastal bluffs. This area was considered to be an area of great power by the local Miwok indians. The Miwok would visit "the hole in the sky" to become revitalized, but never stayed long for fear of harmful side effects, so the legend goes. Bolinas is an area of exceptional natural beauty and biological diversity. Its lagoon and reef are home to numerous marine species. Bolinas is host to a vast array of migratory birds that make it a stopping point along their route. In general, Bolinas is mostly grasslands, serving as livestock pastures. Numerous small hills and ravines are scattered throughout the area, with thick underbrush like coyote bush, blackberry and poison oak. Surrounding



main underground

Bolinas are large, steep hillsides with thick conifer forests. At one time these hills were the Redwood empire.

6) Today, the

4) The geology of Bolinas is a series of coastal points consisting of brittle shale and slate along with large masses of clay mixed with very fine sand. Bolinas is a giant sponge soaked with water from the great forests to its north. Widespread underground water flow exists, creating much coastal erosion. Drainage is very difficult due to the sheer saturation. This ground water holds a great abundance of the element iron. Colloidal iron can be seen dripping from cliffsides, and plants often turn red upon being fed Bolinas ground water. Also abundant is the element sulphur, found in native form on coastal outcroppings. Small deposits of oil and gas are to be found at the Bolinas site. Gas bubbles can be seen in the tidepools of the reef. A few attempts were made to locate any significant quantity of oil that may have been present. None was found. It is ironic that the Bolinas site would become the burial ground for the 1972 San Francisco oil spill. The reef extends several hundred feet out to sea like a giant slate floor. The grain of the rock is somewhat vertical, giving the reef numerous small ridges. Many ships and their crews met disaster on this reef.

inflicted

Bolinas is the meeting point of the Pacific plate and the American continent. Three geological fault lines enter the Pacific Ocean at Bolinas. Most notable is the San Andreas which makes up the Bolinas Lagoon. Originating in the town is the San Gregorio fault, and the third fault has no name. The San Andreas returns to land at San Bruno, a few miles south of San Francisco. The San Gregorio touches land at Montara, Halfmoon Bay and San Gregorio, staying close to the coast through Big Sur, 100 miles south of San Francisco. The third fault goes out to sea.

3000

5) With a saturation of iron rich ground water it is no surprise that Bolinas offers great enhancement to radio propagation. Recent tests indicate a 20 to 30 decibel improvement (100 to 1000 times) in signal strength for signals originating in the Bolinas locale. Some of the coast's deepest canyons still had strong signals from Bolinas. Very anomalous reception of Bolinas signals was noticed in the Los Angeles area, about 500 miles to the south. The iron-sulphur mix of Bolinas is suggestive of the old wireless semiconductors like iron sulphide (pyrite) or lead sulphide (galena). Broadcast station signals of the A.M. band would be received strongly intermodulated when received on grounded aerials at Bolinas. This would indicate the ground to be a semi-conductor. This is worthy of further study as an instrument of fault line measurements. It is thought by some that Marconi personally selected the Bolinas location for its geo-electric properties, however this has yet to be verified. The Marshall receiving site was said to be an exceptionally low noise area, and thus chosen for the site. It is to be noted that the nearly one million square feet of underground wires and metal plates are mostly intact. Metal plates are even found out at sea but these no longer connect to the

main underground electrode. Such a structure is a geo-electric treasure with important scientific uses.

6) Today, the Bolinas site sits in peril, its transmitters cold. It became the victim of a dying R.C.A. which, like a drowning man, pulled the station down with it. Today the site is the victim of a resident political organization, calling itself Commonweal. Commonweal is an old English word for central wealth. Commonweal destroyed most of the original shortwave equipment that once occupied the station, and dumpstered most of the historic records. Commonweal presently is holding a death grip on the site, blocking any and all efforts to use or preserve it. It is fortunate that the Bolinas site is now under the control of the Department of the Interior, National Park Service, Point Reyes National Seashore. This will assure its protection. The Marconi Powerhouse, called building number one, or just the "other building," sits in very bad repair. In violation of its lease agreement, Commonweal has refused to either maintain the building, or allow entry to those who would. The historic transmitter BL-10 that sits inside has been partially stripped by Commonweal underlings, but is repairable. M.C.I. Corporation stripped the building of its primary switch gear, leaving it without power. In all it is estimated that ten million dollars worth of damage has been inflicted upon the Marconi Powerhouse by R.C.A., M.C.I., General Electric, and Commonweal.

The original shortwave building, number two, has been completely stripped by Commonweal and of all things, ~~and~~ is now an office building and party hall. The annexed building, "2A," still houses an intact shortwave transmission facility and was under the protection of M.C.I. Corporation. At present it does not operate on the air. Thirty-some odd dipole antenna arrays occupy about 100 acres of the once 3000 acre antenna. All original antennae are now gone. The northwest portion of the antenna farm has been taken over by the Coast Guard Master Communication Station Pacific, NMC. NMC maintains the necessary H.F. communications left behind by R.C.A. and transmits its operational traffic.

7) The Bolinas site is a technological facility with an extensive history and potential future uses in science and technology. It is hoped that the National Park Service will take the proper steps to assure the site keeps with its nearly 100-year tradition.



# Transatlantic Wireless Telegraphy

## THE NEW JERSEY STATION

GOOD progress is being made with the construction of the high-power stations which, when completed, will add enormously to the public facilities for the use of transatlantic wireless telegraphy. The Clifden-Glace Bay service, which, since 1908, has been in regular continuous communication, day and night, carrying commercial, public, and press messages, has

cation which the cheapness and efficiency of the Marconi service has made possible.

From time to time we hope to be able to furnish our readers with details of the stations which are being erected on both sides of the Atlantic in fulfilment of this scheme. In the meantime, a few preliminary notes concerning the stations now being erected near New York may be of interest.

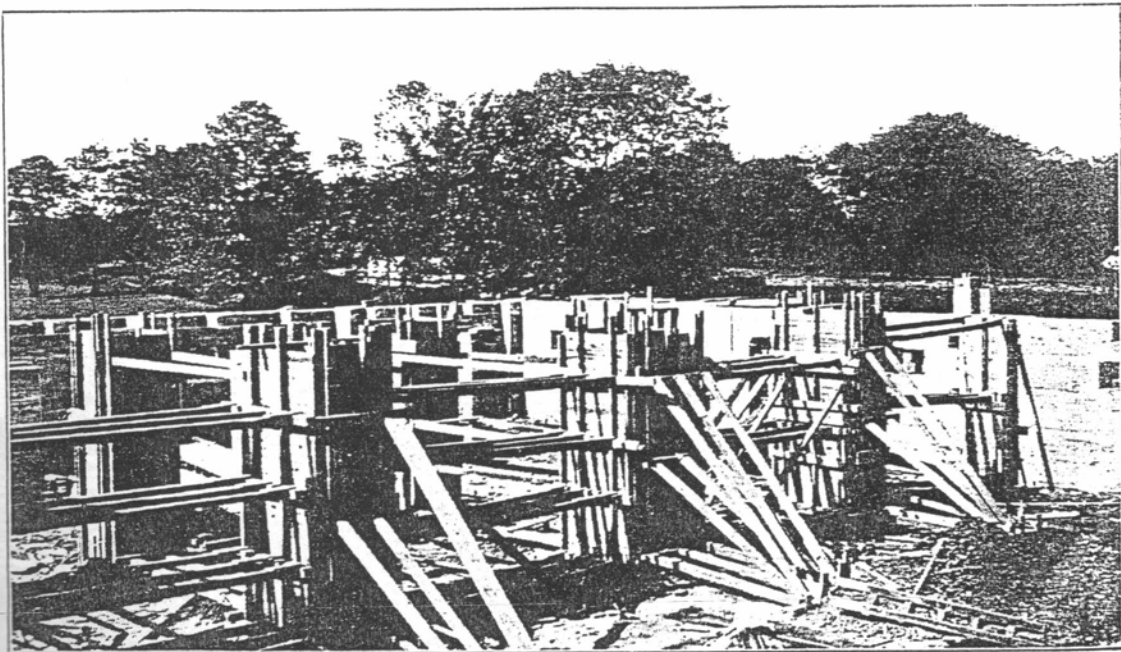

*Site of the Transmitting Section of the New Jersey Station, New Brunswick.*

hitherto been the only service in existence affording direct wireless communication between the Eastern and Western hemispheres. But it will not long enjoy its "splendid isolation," for other stations are now being erected which will bring the North American Continent nearer (in a telegraphic sense) to England and other European countries, thus relieving the pressure of traffic upon the Clifden-Glace Bay stations, and coping with the enormously increased use of transatlantic telegraphic communi-

Two miles out from the historic city of New Brunswick, N.J., on a road that follows the banks of the Raritan river and the Raritan canal, lies the transmitting section of the wireless station which will bring the United States in direct communication with England. Approaching the site from the south one sees a beautiful meadow stretching from the road to the canal bank. In this meadow are located the power-house, the auxiliary transmitting office, and the first set of two masts. To the west of the road

the land rises sharply for about a thousand feet, and then runs nearly level for a mile or more. Looking up this rise the two cottages for the chief engineer and the assistant engineer are to be seen, and, further up the hill, the building which will accommodate the engineering staff, the operators required to work the auxiliary receiving apparatus and the riggers who keep the aerials and the mast system in shape.

The power-house is now beginning to take shape, for the concrete work is completed up to the first story and ready for the brick work. The foundations for the motor generators are well under way, and the steel girders and beams for the first floor are being erected. A feature which cannot fail to be noted is the permanent and fireproof nature of the work on all of the buildings.

The auxiliary operating building is about 100 feet north of the power-house, has the brick work completed to the roof, and awaits the steel and roof tile to finish the structure of the building. All the buildings at this station are of rough tapestry brick, laid up

with a wide joint in black mortar. With red tile roofs and an attractive design they make a handsome appearance.

An old historic farmhouse, long since past its prime, is being utilised as the construction office. This house has stood for more than one hundred and fifty years, and, judging from the appearance of the huge hand hewn timbers, will stand for another century or so. In revolutionary days this dilapidated house was a mansion of importance, having been at one time the paymasters' office of the Revolutionary Army; and rumour has it that Lafayette had his headquarters here for a time during the American War of Independence.

The receiving section of the New Jersey station is at Belmar, the road to which leads along the Shark River, a famous salt water inlet, which, during the summer months, is the resort of launches and other pleasure craft. The countryside looks rather deserted as one travels to the Marconi Station. At the station, however, all is life and bustle.

The operating house is at the foot of the

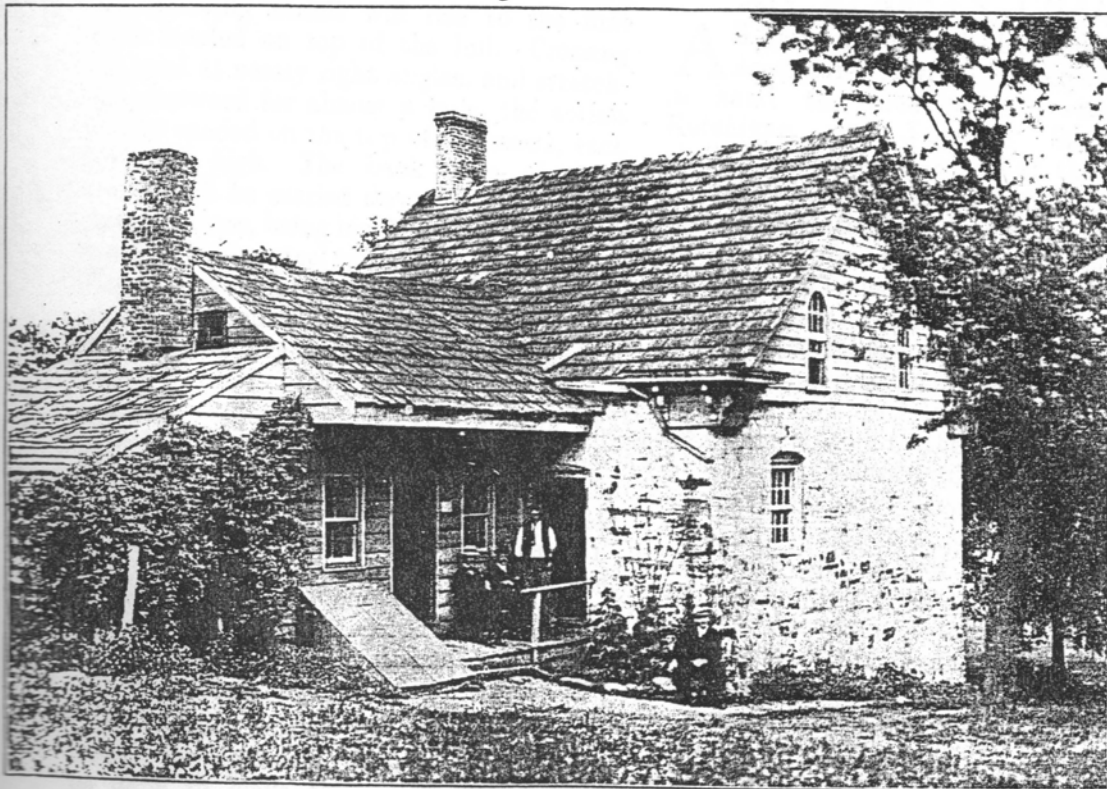

*"Lafayette House." An historic dwelling converted to the use of the Staff erecting the New Brunswick Station.*



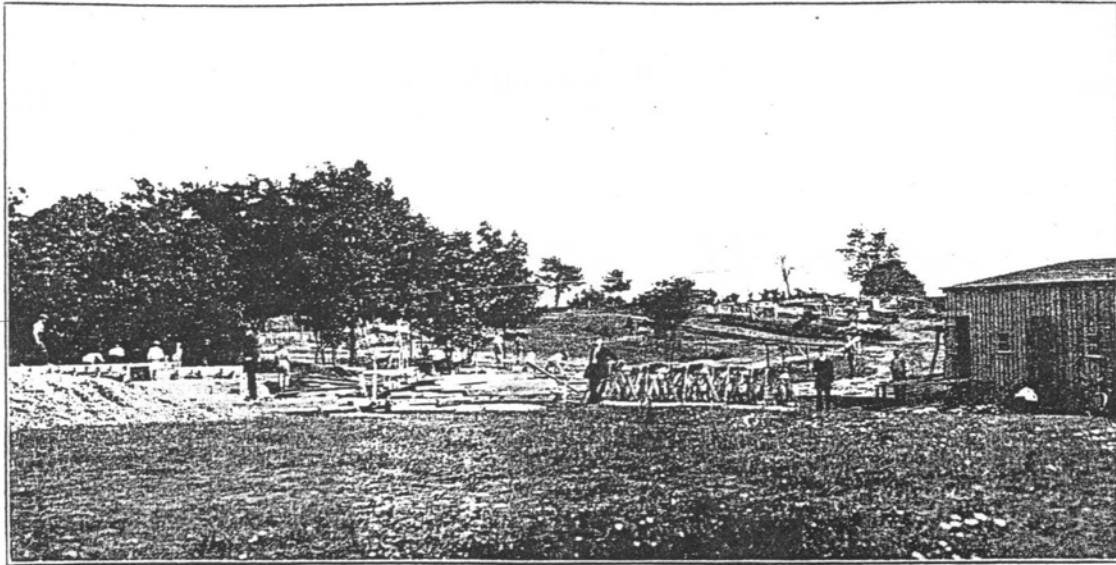

*Digging Foundations for the Receiving Station at Belmar, N.J.*

hill close to the river. From this building the receiving aerials will rise to the first mast located on top of the hill. Crossing the road at nearly right angles, and stretching westward for almost a mile, the aerials will be carried on the top of six masts, each 300 feet high. The back ends of these aerials will be carried down at an angle of thirty degrees, being insulated near the mast top and having steel running ropes attached. These ropes come down to the anchors, which consist of a pillar 15 feet high, with heavy iron weights free to slide up and down on them.

These weights balance the pull of the wires and are calculated to keep a definite tension in the aerial wires at all times, so that when the wind blows or sleet incrusts the aerials, the spans between the masts will sag down and the counterweights rise, keeping the tension constant. This straining pillar anchorage, as it is called, is an ingenious device which is a new departure in cable suspension.

At Belmar a large force is required to handle the operating work, and much will be done to make the residential quarters attractive to live in. Summer boating on Shark River is a pastime which is looked forward to with pleasure, while tennis and outdoor sport will be encouraged; in fact, a happy little community will soon be thriving in this neighbourhood.

### AN ALASKAN CHAIN.

AS we announced last month, the American Marconi Company have in hand the erection of stations at Ketchikan and Juneau. Stations are already in existence at both of these points, but only ship business is handled. An entirely new station will be erected at Ketchikan, consisting of a 15-kw. synchronous rotating gap transmitter of the latest type and the usual receiving apparatus. Four skeleton steel towers will be erected, and the antenna so arranged as to work efficiently with Seattle, a distance of some six hundred miles to the south.

Ketchikan station will also work to the north to a distance of more than two hundred miles with the station at Juneau, Alaska. This latter station will be entirely rebuilt, and will be fitted with a 10-kw. transmitter and two skeleton steel towers.

These two stations are intended to be the first links of a chain to provide Alaska with a commercial wireless service connecting it with the United States. As business develops, the chain will be developed and provided with feeders further north.

The existing cable rate between Juneau and Ketchikan is 6 cents per word, and between Ketchikan and Seattle 19 cents per word. It is probable that the rates for communication between these points will be considerably reduced when the Marconi service is inaugurated.

# Trans-Pacific Wireless Telegraphy.

Marconi Stations in California Nearing Completion.

THE Marconi high-power stations in California are rapidly nearing completion. These stations will be made up of the transmitting plant at Bolinas Point, eighteen miles north-west of San Francisco, and the receiving station, near the town of Marshalls, about eighteen miles further north on Tomales Bay. Despite the diffi-

regularly used for traffic. There is no railway available, and it is necessary to send the material by water from San Francisco, unload it at the wharf at Bolinas Bay, and haul it to the site. Across the mouth of the bay is a shallow sand bar which makes it impossible for a boat of any size to get to or from the wharf except at high tide, and the

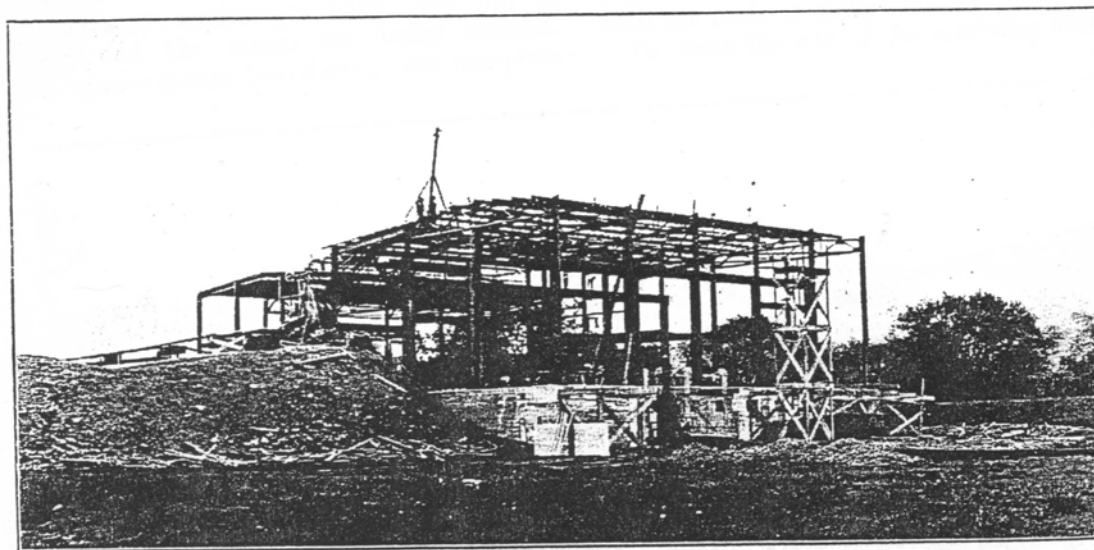

*Bolinas Power House in Course of Construction.*

culties attending the transportation of building material, the progress on the California sites has been satisfactory. Most of the material for erection purposes—steelwork and machinery, as well as all mast sections and the wire rope—is being made in the East. It is sent from New York by boat to the Isthmus of Panama, across the isthmus by rail and thence by water again to San Francisco.

The site at Bolinas is not advantageously located for bringing in heavy loads of material. The rough roads leading to it are at least four miles distant from the highway

coast is so dangerous to shipping that owners of vessels are reluctant to have their craft navigated in and out of the bay. As a matter of fact, only one small schooner enters the bay, and she makes the trip only when there is enough material to warrant it. The construction work has strained to the utmost the schooner capacity of 100 tons and overloaded the wharf. A larger derrick has been installed to unload the heavier pieces and the area of the wharf has been extended to give greater space for materials. The fear of winter storms and consequent impassable roads has stimulated the men in



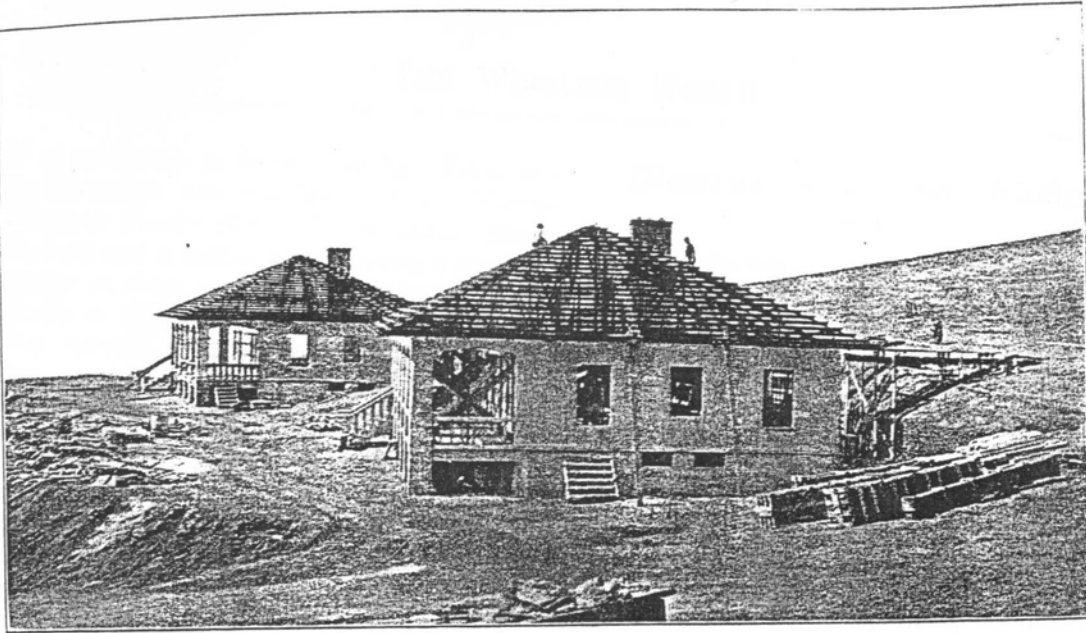

*Residences for Chief and Assistant Engineers at Bolinas.*

charge of the work to make every effort to transport the machinery and heavy materials as quickly as possible.

The buildings are located on an incline at a height of about 160 feet and within 500 feet from the shore.

The stay anchorages have been put in place and the masts are being erected. The power-house foundations are complete

and the piers and foundations for the motor generators, disc dischargers, and other machinery are being erected. Rapid progress is being made in the construction of the headquarters and the residences for the chief and assistant engineers. These buildings are constructed of steel and concrete, with tile roofs to make them fireproof.

To reach the site of the receiving station

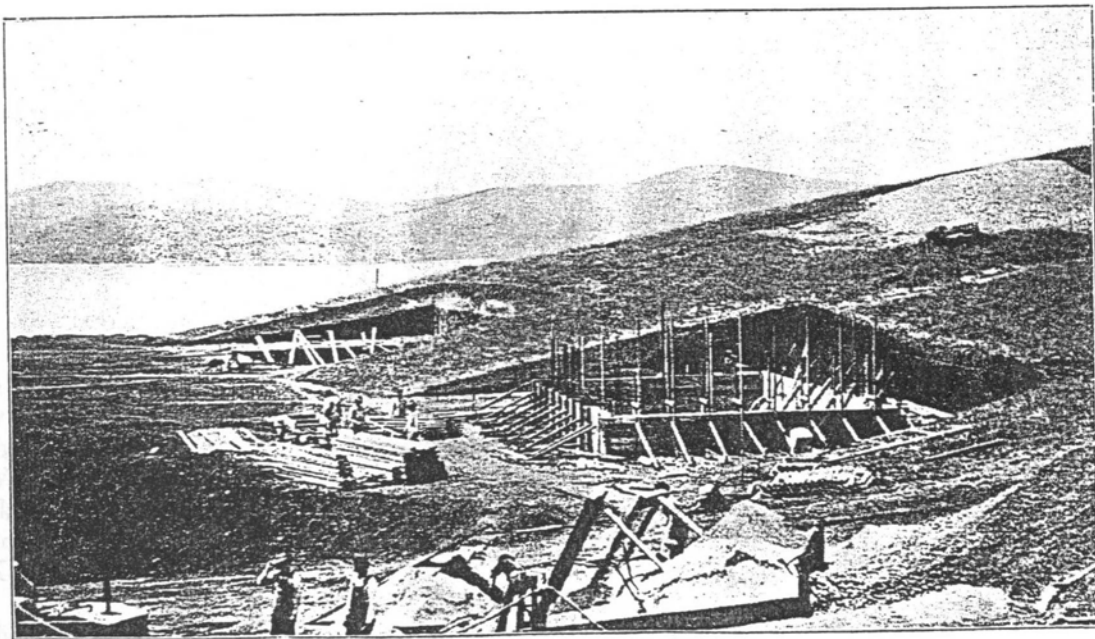

*At the Site of the Receiving Station, Marshalls.*

it is necessary to ferry from San Francisco to Sausalito, board a train on the North-Western Pacific Railroad, and travel about an hour and a half or two hours on a narrow-gauge railway to the little town of Marshalls on the eastern shore of Tomales Bay. For several months workmen have been busy in this section, with the result that considerable progress has been made in the construction of the buildings which now form a feature of the hillside.

Tomales Bay, celebrated for its clams and oysters, is about twelve miles long and a mile wide. It is navigable for good-sized boats and is extremely popular with fishermen. On the eastern shore, just south of the Marconi property, is located a fishing colony. Along both shores the hills rise abruptly and stretch away on the eastern side in a rolling tableland. The tongue of land between the bay and the ocean is about three miles wide. Covered with heavy woods, this promontory is a favourite summer resort for campers and hunters. It affords good duck shooting and deer are also to be found in the woods. The residential quarters and section for the housing of the lighting and heating plant are about three hundred yards south of the line of the aerial; the operating building at the end of the aerial line is nearly a fifth of a mile from the other structures. These are arranged in a semi-circle above the country road, looking out over the bay from an elevation of one hundred feet. The operating building is on the top of a hill on an elevation of about one hundred and thirty feet.

The construction of the buildings has advanced rapidly. Satisfactory progress has been made on the mast erection. One mast has been completed and stayed, while all the others have at least four sections up. The top plate of the mast foundation can now be accurately levelled up and the last grouting concrete poured.

With regard to the station at Honolulu, work is going along satisfactorily, 141 persons being employed at Kahuku and 108 at Koko Head.

The November meeting of the Institute of Radio Engineers was held at Columbia University, New York, on the 5th ult., when a paper entitled "The Audion—Detector and Amplifier" was read by Dr. L. de Forest.

### Directory of Amateur Wireless Stations.

IT is estimated that there are about one thousand licensed amateur experimenters in wireless telegraphy in Great Britain, and this number is steadily increasing. It is only natural, therefore, that there should be a demand for facilities to enable these experimenters to get in touch with their neighbours, which at present they are unable to do in the absence of a suitable directory.

We have decided, therefore, in the interests of the *bonâ fide* amateur, and at the suggestion of some of our readers, to undertake the preparation of a complete directory of amateur wireless stations, which we hope to publish as a special supplement to an early number of THE WIRELESS WORLD.

We believe that the publication of a directory such as we have in view will bring to light a large number of experimenters whose existence is unknown to their neighbours. It will encourage the establishment of wireless associations, and will help to strengthen existing associations by increasing the status of the amateur.

We feel confident that in the compilation of this directory we can rely upon the assistance of the members of the amateur wireless societies and others who are not associated with those organisations, and to whom the existence of a reliable directory will prove of inestimable value.

We shall be glad, therefore, if readers will send us, at an early date, the following particulars for inclusion in the directory:

Name and address.

Call-letters.

Whether the station is for transmitting and receiving, or receiving only.

Transmitting range, in miles.

Transmitting wave-length, in metres.

Receiving range.

Usual hours of working.

General remarks.

Secretaries of wireless associations and clubs will oblige by sending names of their officers, address of headquarters, call-letters and any other useful information.

This directory, when complete, will be distributed free of charge to our readers.



## ON THE GENERATION OF LONGITUDINAL WAVES IN ETHER.<sup>1</sup>

IN a short note published in NATURE of February 6, I suggested an arrangement of four insulated and electrified spherical conductors with their centres in one line, giving rise to ethereal waves in the surrounding atmosphere, of which the disturbance in the line of centres is essentially longitudinal. But at any finite distance from this line there must also be laminar or distortional waves of the kind expressed in Maxwell's equations. The object of my present communication is to show an arrangement by which a large space of air is traversed by pressural disturbance, or by waves essentially longitudinal, or by condensational-rarefactional vibrations; with but a very small proportion, practically evanescent, of laminar waves.

Let AA be a plane circular metal plate insulated within a metal case CCC'C, as indicated in the drawing. Let D be a discharger which can be pushed in so as to make contact with A. Let A be charged to begin with, positively for instance as indicated by the letters PPPP; NNNN showing negative electricity

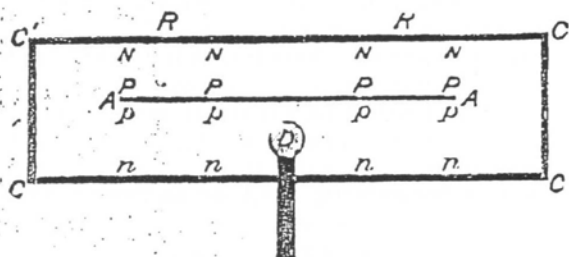

induced by it. Let now the discharger be pushed in till a spark passes. The result, as regards the space between AA and the roof RR over it, will be either an instantaneous transmission of commencement of diminution of electrostatic force, or a set of electric waves of almost purely longitudinal displacement, according as ether is incompressible or compressible.

Hence, if the theory of longitudinal waves, suggested by Röntgen as the explanation of his discovery (for the consideration of which he has given strong reasons), be true, it would seem probable that a sensitive photographic plate in the space between AA and RR should be acted on, as sensitive plates are, by Röntgen rays. Either a Wimshurst electrical machine or an induction-coil, adapted to keep incessantly charging AA with great rapidity so as to cause an exceedingly rapid succession of sparks between D and A, might give a practical result. In trying for it, the light of the sparks at D must be carefully screened to prevent general illumination of the interior of the case and ordinary photographic action on the sensitive plate.

The arrangement may be varied by making the roof of sheet aluminium, perhaps about a millimetre thick, and placing the sensitive photographic plate, or phosphorescent substance, on the outside of this roof, or in any convenient position above it. When a photographic plate is used there must, of course, be an outer cover of metal or of wood, to shut out all ordinary light from above. This arrangement will allow the spark gap at D to be made wider and wider, until in preference the sparks pass between AA and the aluminium roof above it. The transparency of the aluminium for Röntgen light will allow the photographic plate to be marked, if enough of this kind of light is produced in the space between the roof and AA, whether with or without sparks.

<sup>1</sup> A paper by Lord Kelvin, read before the Royal Society on February 12

ELECTRIC THEORY UN-ACCEPTED  
BY PHYSICAL SCIENCE, EXAMPLE



The new photography has hitherto, so far as generally known, been performed only by light obtained from electric action in vacuum; but that vacuum is not essential for the generation of the Röntgen light might seem to be demonstrated by an experiment by Lord Blythwood, which he described at a meeting of the Glasgow Philosophical Society on Wednesday, February 5. As a result he exhibited a glass photographic dry plate with splendidly clear marking which had been produced on it when placed inside its dark slide, wrapped round many times in black velvet cloth, and held in front of the space between the main electrodes of his powerful Wimshurst electrical machine, but not in the direct line of the discharge. He also exhibited photographic results obtained from the same arrangement with only the difference that the dark slide, wrapped in black velvet, was held in the direct line of the discharge. In this case the photographic result was due, perhaps wholly, and certainly in part, to electric sparks or brushes inside the enclosing box, which was, as usual, made of mahogany with metal hinges and interior metal mountings. It is not improbable that the results of the first experiment described by Lord Blythwood may also be wholly due to sparking within the wooden case. I have suggested to him to repeat his experiments with a thoroughly well closed aluminium box, instead of the ordinary photographic dark slide which he used, and without any black cloth wrapped round outside. The complete metallic enclosure will be a perfect guarantee against any sparks or brushes inside.

If the arrangement which I now suggest, with no sparks or brushes between AA and the roof, gives a satisfactory photographic result, or if it shows a visible glow on phosphorescent material placed anywhere in the space between AA and the roof above it, or above the aluminium roof, it would prove the truth of Röntgen's hypothesis. But failure to obtain any such results would not disprove this hypothesis. The electric action, even with the place of the spark so close to the field of the action sought for as it is at D, in the suggested arrangement, may not be sudden enough or violent enough to produce enough of longitudinal waves, or of condensational-rarefactional vibrations, to act sensibly on a photographic plate, or to produce a physical glow on a phosphorescent substance.

---

MARCH 12, 1896]

---

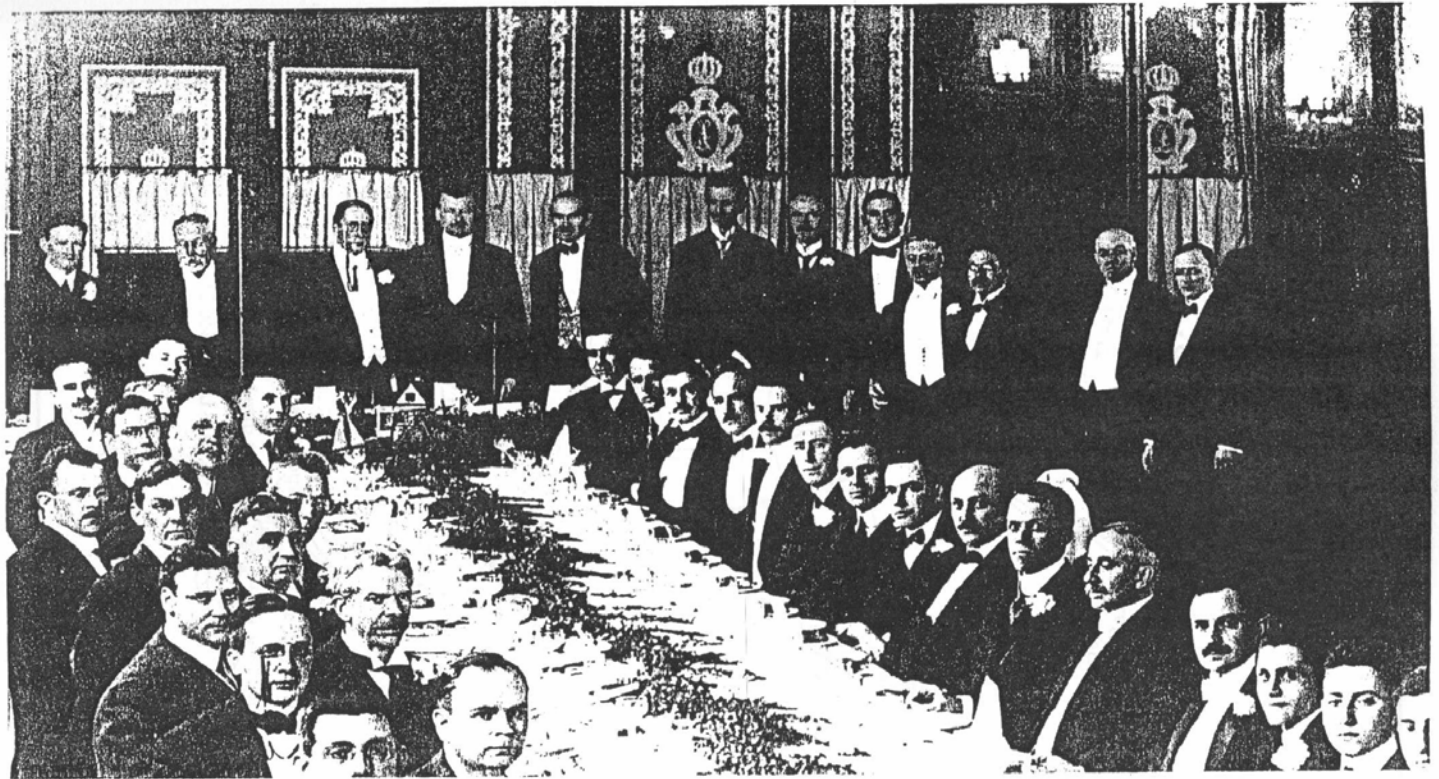

Second banquet meeting of the Institute of Radio Engineers (now part of the Institute of Electrical and Electronic Engineers) at Luchow's in New York City, April 24, 1915.

Photo by C.A. Schere  
Smithsonian Institution

Standing at back from left,

- |                     |                    |                     |                     |                  |                 |                     |                        |                            |
|---------------------|--------------------|---------------------|---------------------|------------------|-----------------|---------------------|------------------------|----------------------------|
| George W.<br>Pierce | Ferdinand<br>Braun | John Stone<br>Stone | Jonathan<br>Zenneck | Lee de<br>Forest | Nikola<br>Tesla | Fritz<br>Lowenstein | Alfred N.<br>Goldsmith | Ernst F.W.<br>Alexanderson |
|---------------------|--------------------|---------------------|---------------------|------------------|-----------------|---------------------|------------------------|----------------------------|



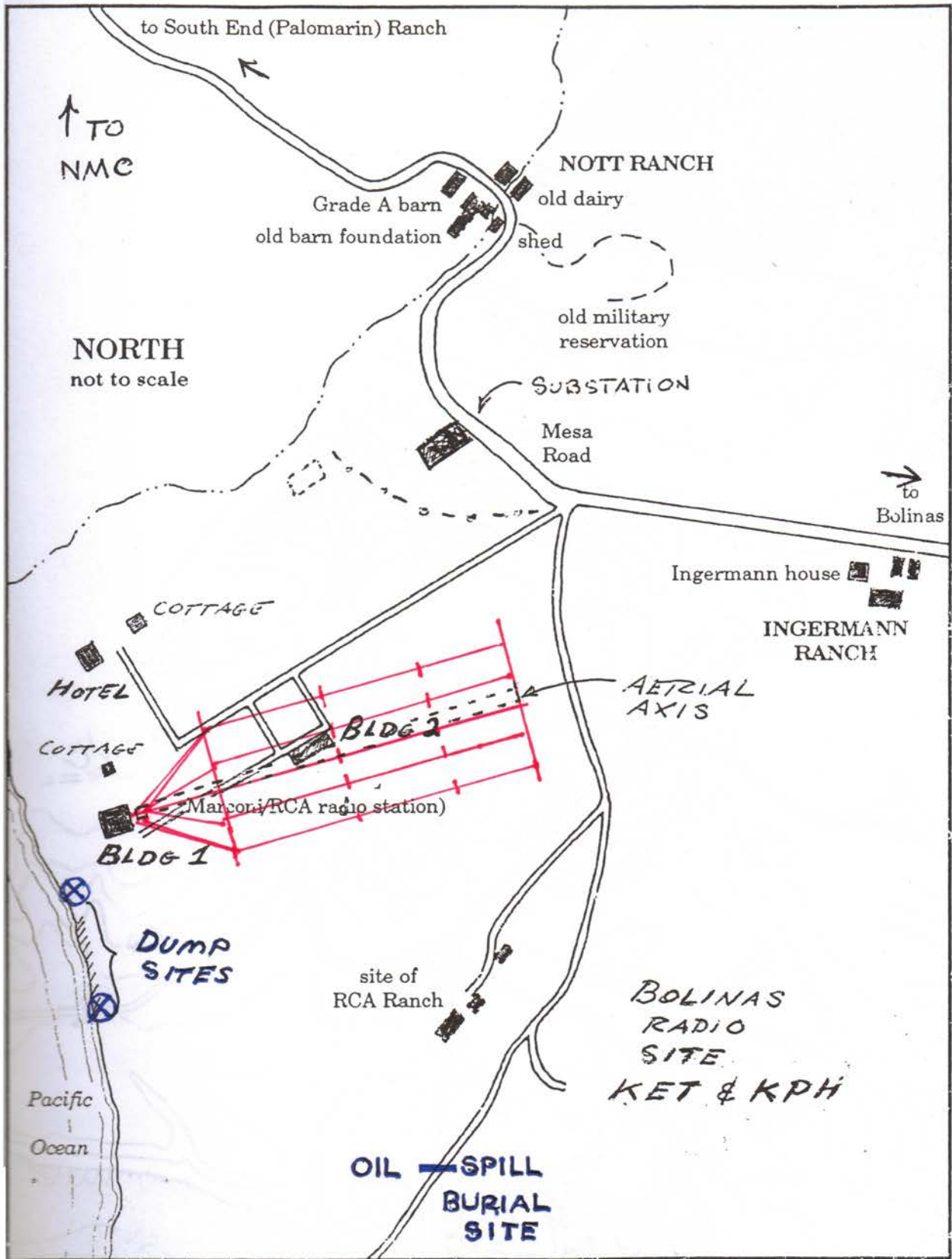

THE BOLINAS  
SITE  
FIG. 1

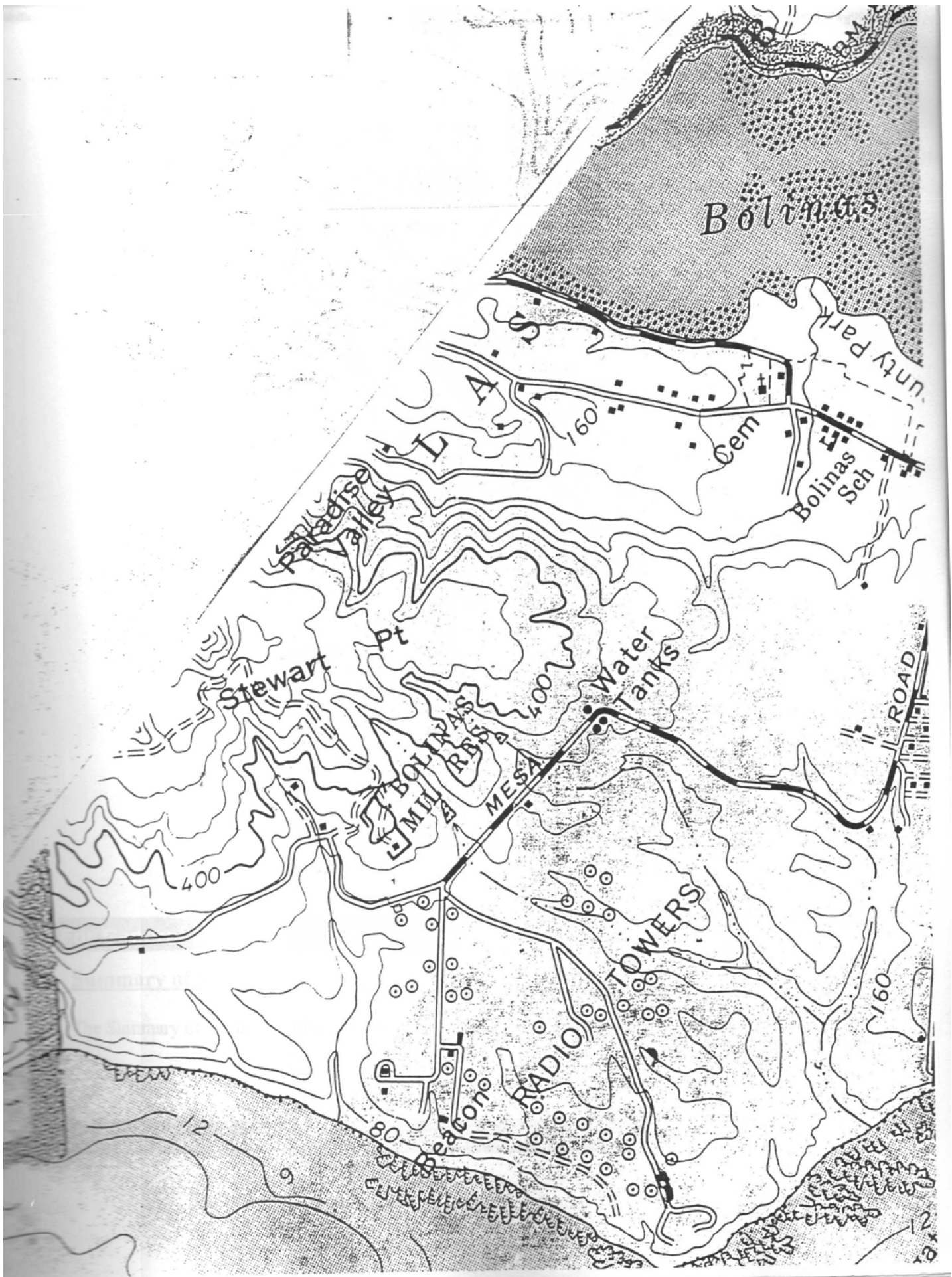



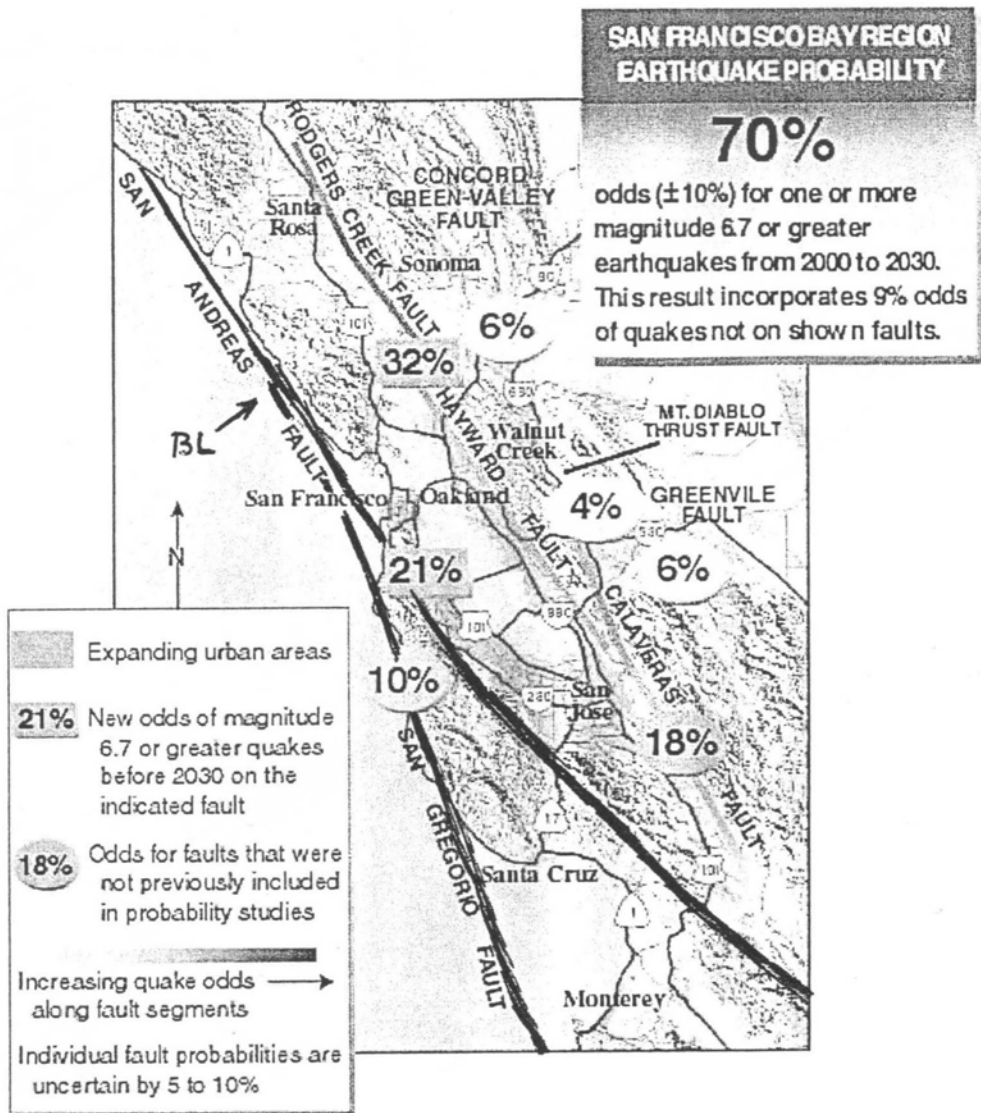

## How to Prepare for Earthquakes

### **For General and Technical Audiences**

#### Summary of Findings

The Summary of Findings is also available in [.pdf version](#) (requires [Adobe Acrobat reader](#))

### **Selected Background Reading for Technical Audiences**

16

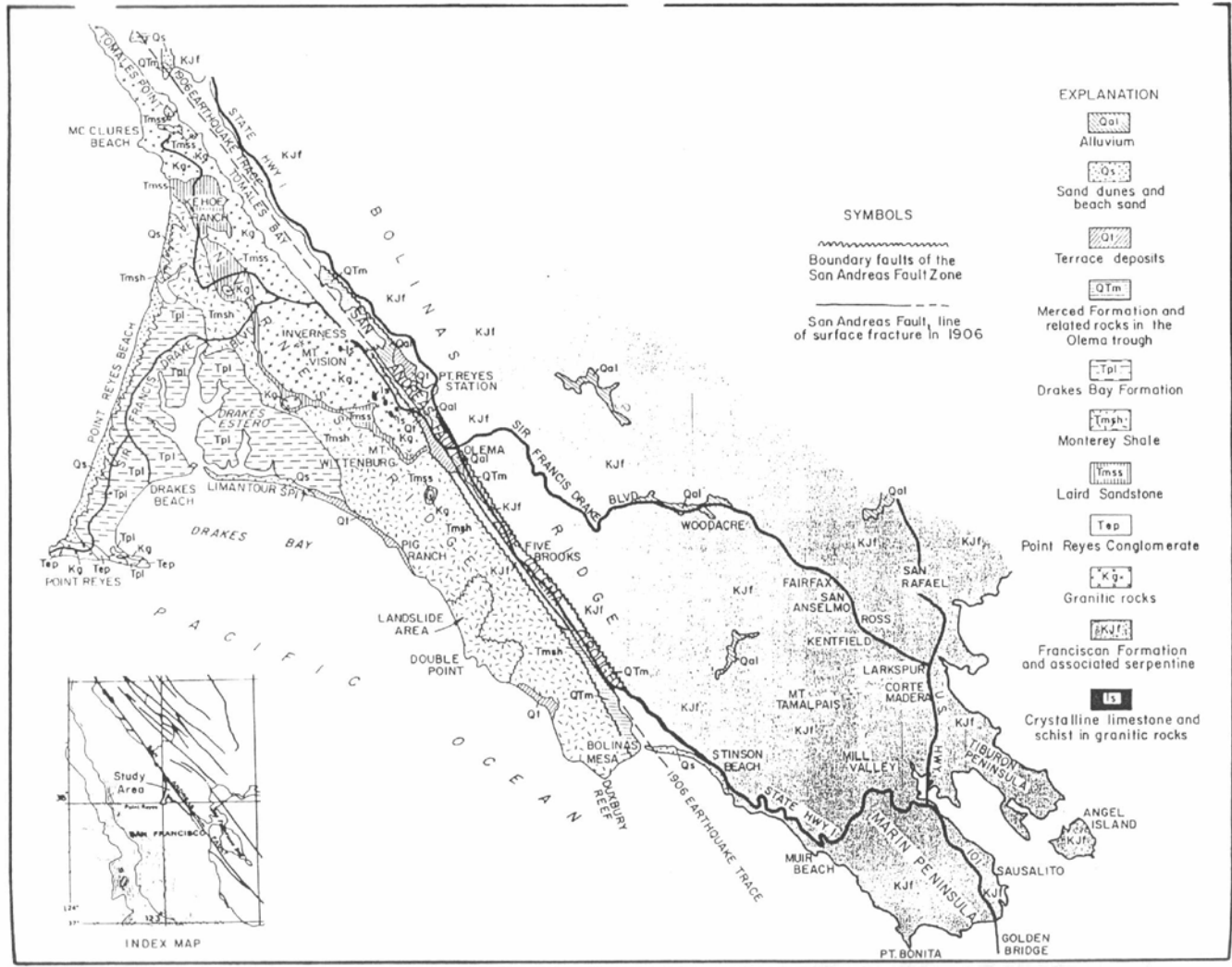



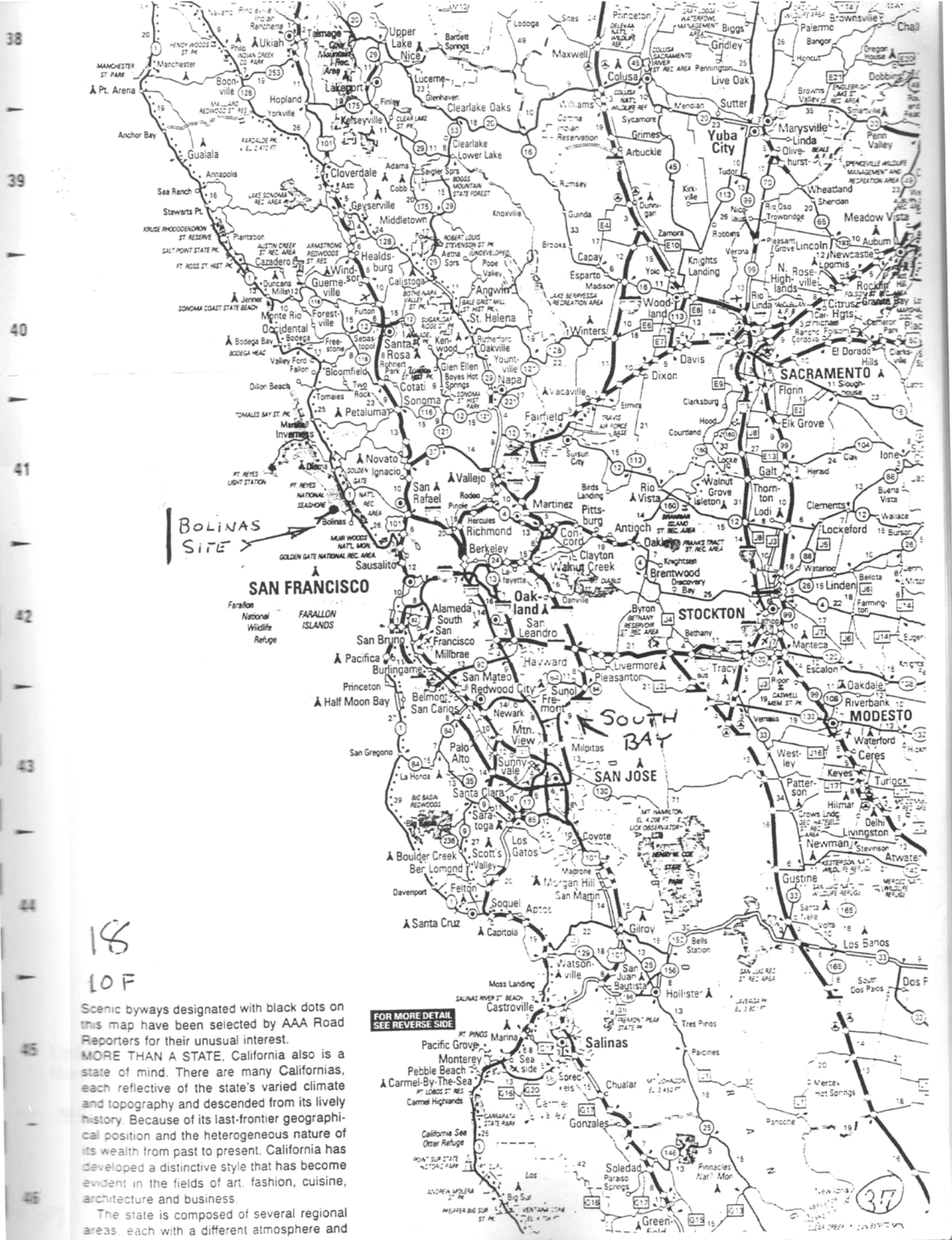

38  
39  
40  
41  
42  
43  
44  
45  
46

BOLINAS  
SITE

SAN FRANCISCO

SOUTH  
BA

SAN JOSE

FOR MORE DETAIL  
SEE REVERSE SIDE

18  
10F

Scenic byways designated with black dots on this map have been selected by AAA Road Reporters for their unusual interest. MORE THAN A STATE. California also is a state of mind. There are many Californias, each reflective of the state's varied climate and topography and descended from its lively history. Because of its last-frontier geographical position and the heterogeneous nature of its wealth from past to present, California has developed a distinctive style that has become evident in the fields of art, fashion, cuisine, architecture and business.

The state is composed of several regional areas, each with a different atmosphere and

37



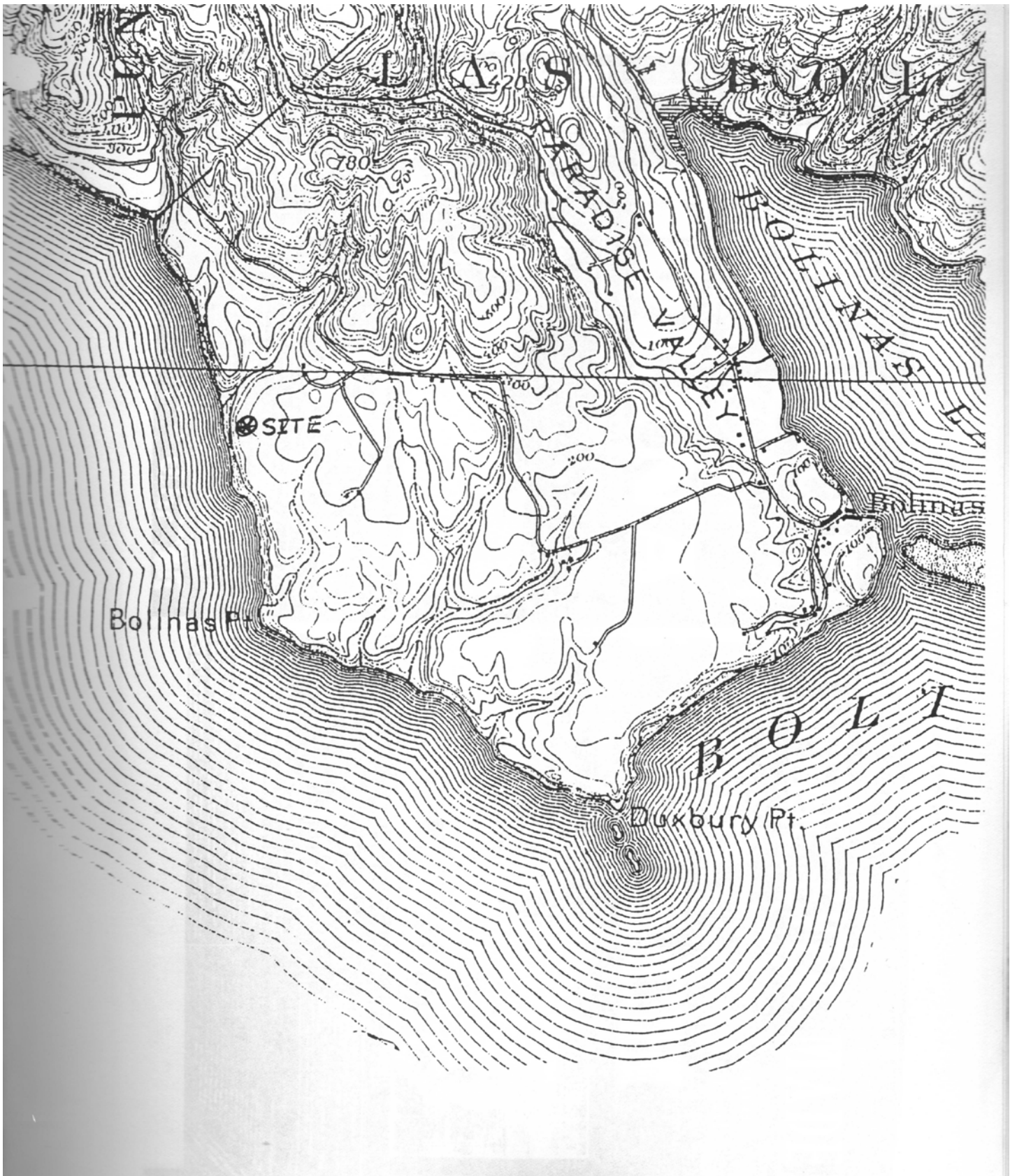





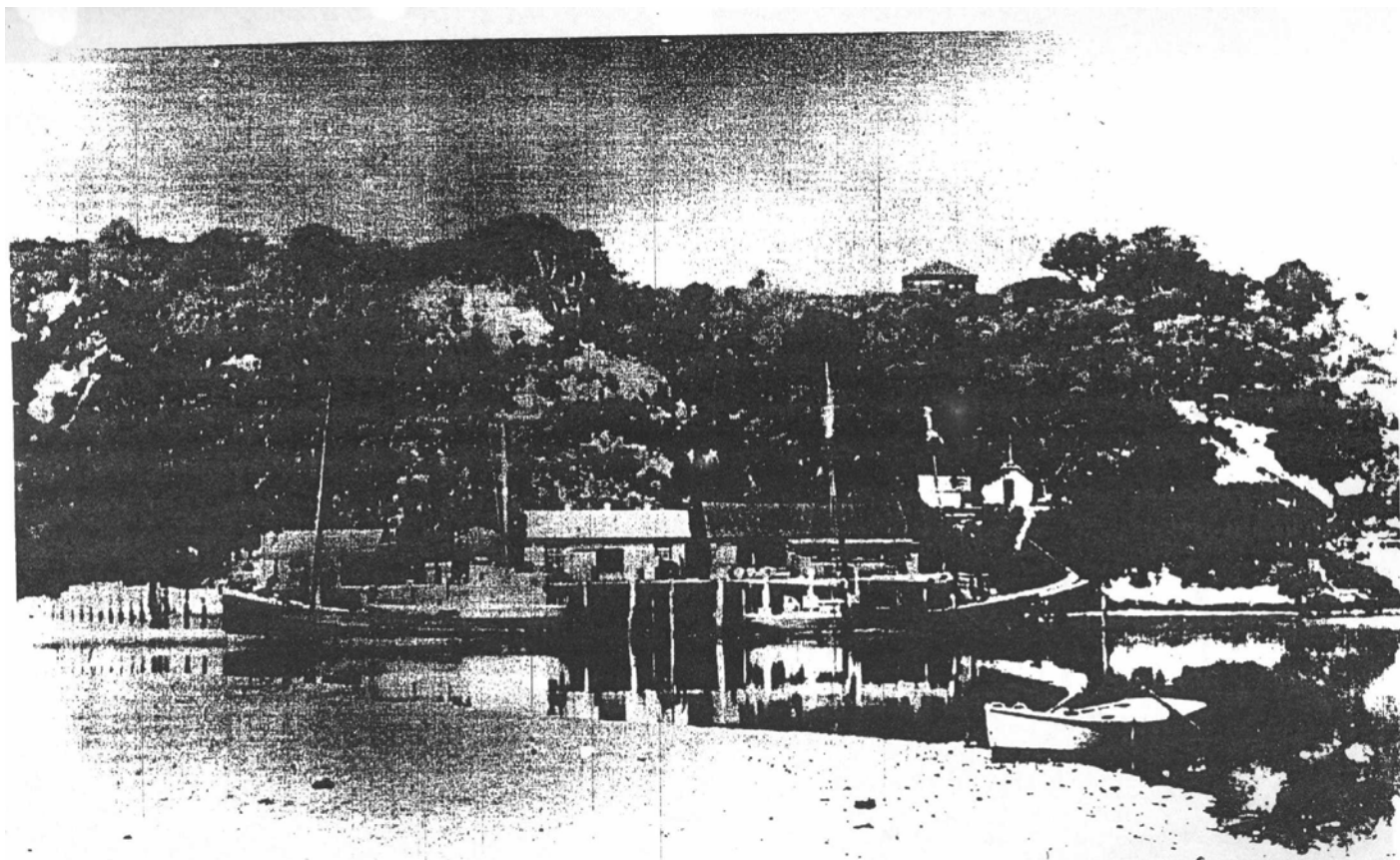

10. The end of Wharf Road, ca. 1914. The two boats are the Power Boat Owl which carried butter, eggs, pigs and passengers to San Francisco and the schooner, Jenny Griffin. Note one of the first houses on the Little Mesa.

lot 1727

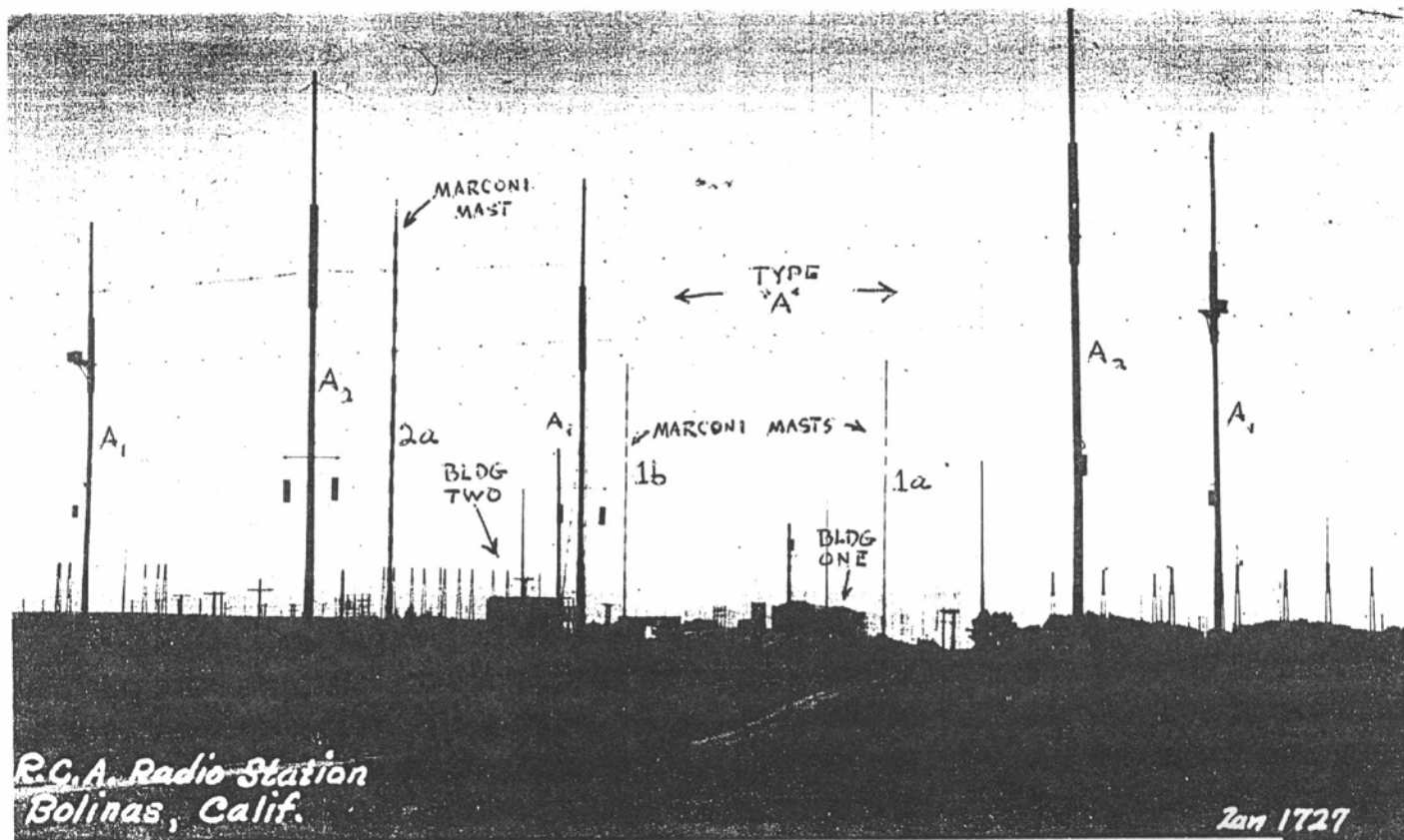

85. RCA, ca. 1925. Originally run by Marconi Wireless, the installation was built in 1913 as a transmitting station. Wireless service between the U.S. and Japan was started in 1914. RCA took the installation over in 1919.



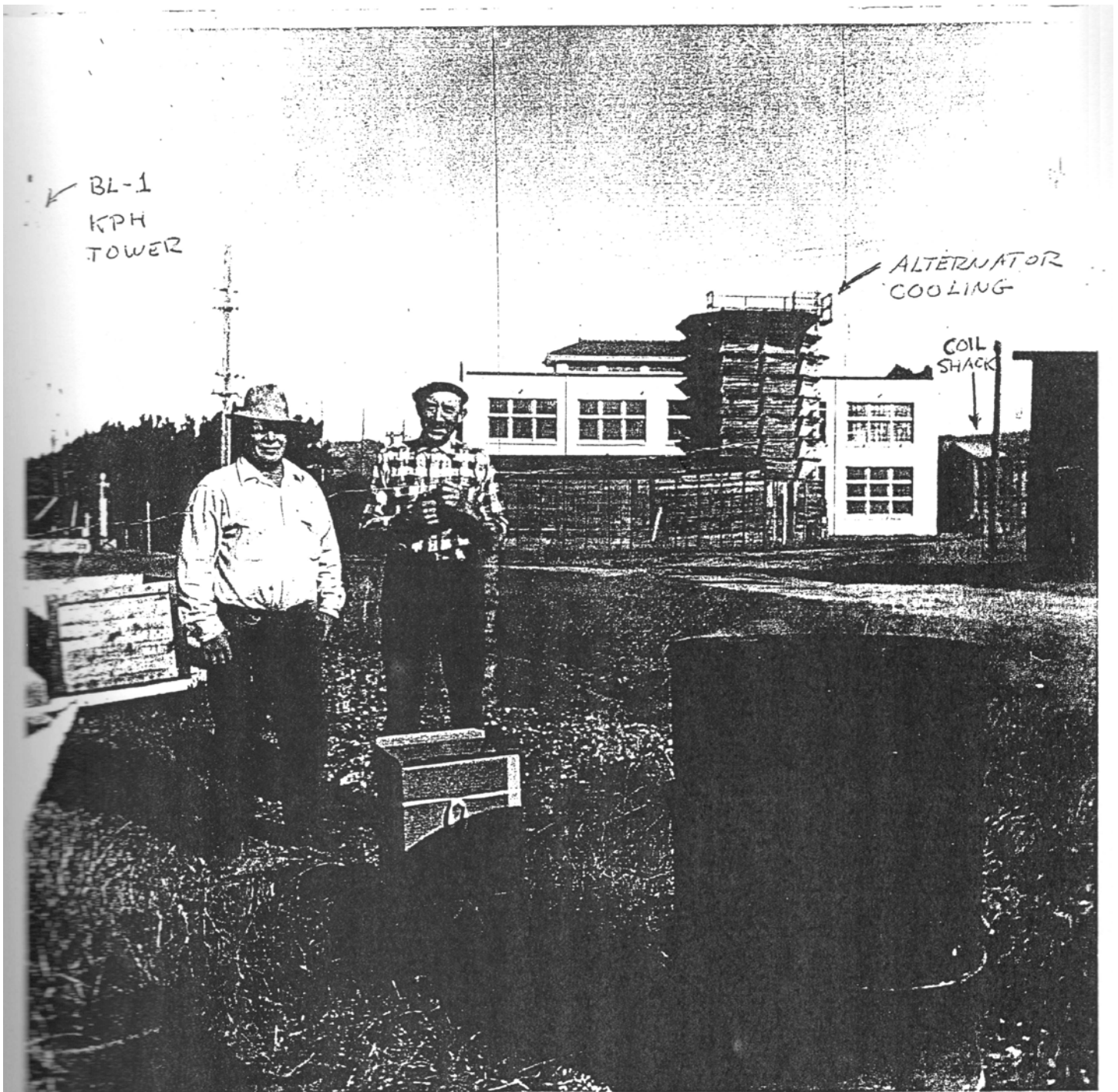

MARCONI BUILDING  
ABOUT 1940 (BOLINAS)

NOTICE

Nov. 25th, 1923.

On Monday P.M. Nov. 26th this station will be inspected by our Chief Engineer, Dr. E.F.W. Alexanderson and Mr. Isbell.

Please see that each watch turns the station over in perfect order.

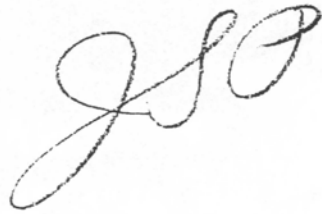

ENGINEER IN CHARGE  
PHILBRICK'S NOTE  
ANNOUNCING THE  
ARRIVAL OF ALEXANDERSON  
AT BOLINAS SITE.





↑ ↑  
2 3

↑ ↑ ↑  
4 5 1

↑  
6

- 1) STEINMETZ
- 2) ARMSTRONG
- 3) SARNOFF
- \* NO MARCONI  
(EVICTED)

- 4) EINSTEIN
- 5) TESLA
- 6) ALEXANDERSON
- 7) NO DE-FORREST?

1921 GATHERING  
OF THE GREAT  
MINDS AT THE  
MARCONI NEW  
BRUNSWICK SITE  
(R.C.A.)



EINSTEIN ↘

STEINMETZ ↘



TESLA  
ERASED FROM  
NEW BRUNSWICK  
PHOTO AND HISTORY

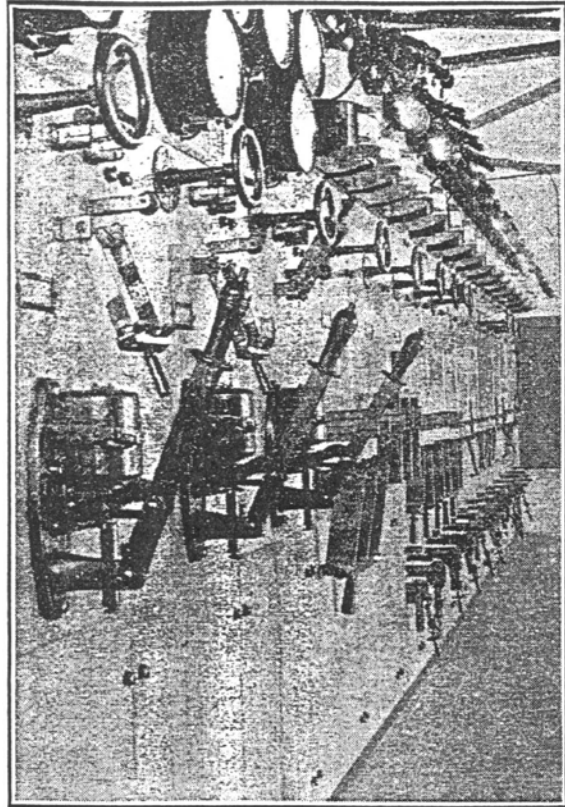

Fig. 308—The Switchboard of the New Brunswick High Power Transoceanic Station.

EQUIVALENT TO  
BOLINAS ITEMS

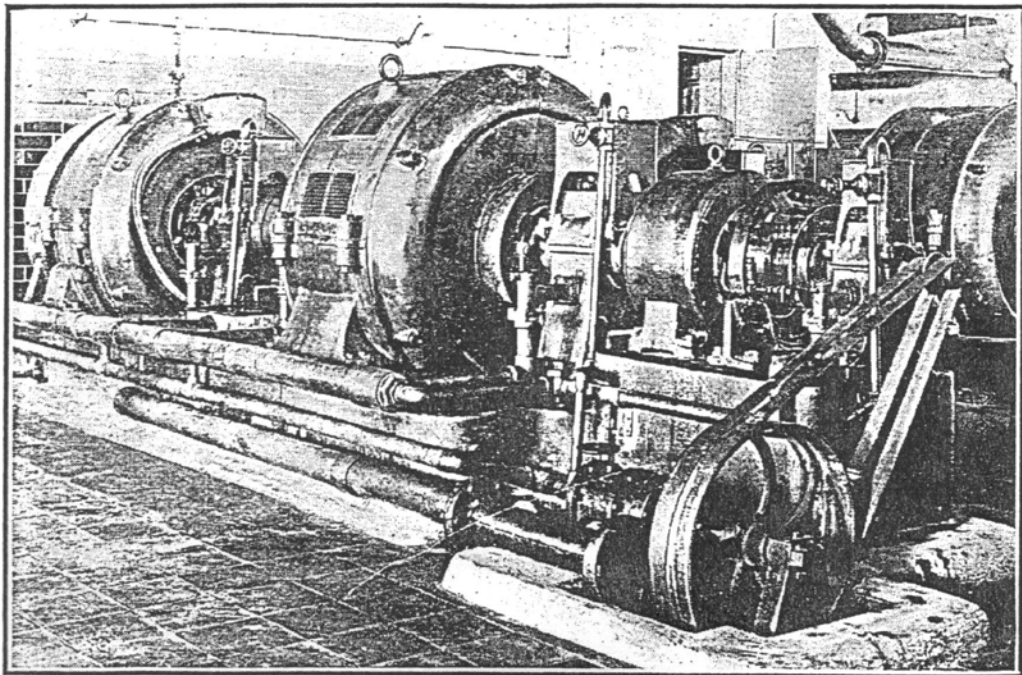

Fig. 305—Three Hundred Kilowatt 150 Cycle Generators at Carnarvon Station.

CONT. HC



# CONNECTING CALIFORNIA WITH HAWAII

*Opening of the Marconi Trans-Pacific Service*



FIG 3

WITH simple but impressive ceremonies the trans-Pacific stations of the Marconi Wireless Telegraph Company of America at Bolinas and Marshalls, Cal., and Kahuku and Koko Head, Hawaii, were formally opened on September 24. The inauguration of the service had aroused interest throughout the world; and men prominent in the affairs of nation and empire sent marconigrams appropriate to the occasion, which marked the opening of three of the largest wireless stations on the globe.

The Marconi Company entertained representative citizens taking part in the inauguration both at Bolinas and Kahuku. In California the members of the San Francisco party invited to the inauguration left the Sausalito ferry at fifteen minutes after nine o'clock on the morning of the opening. They rode in a special car provided by the Northwestern Pacific Railroad, arriving at San Anselmo at fifteen minutes after 10 o'clock. Here they entered automobiles and were driven to Bolinas, which they reached at noon.

Among the guests of the Marconi Company were James Rolph, Jr., Mayor of San Francisco; R. P. Schwerin, Vice President and General Manager of the Pacific Mail Steamship Company; Captain Robert Dollar, President of the Dollar Steamship Company;

M. H. De Young, Vice President of the Panama-Pacific International Exposition; C. F. Michaels, President of the San Francisco Chamber of Commerce; Mr. Forbes, Secretary of the California Development Board; F. S. Samuels, assistant to the President of the Oceanic Steamship Company; C. H. Gaunt, General Manager of the Western Union Telegraph Company, Pacific Coast Division; George E. McFarland, President of the Pacific Telegraph and Telephone Company.

A. P. Taylor, San Francisco representative the Hawaiian Promotion Committee; P. S. Teller, President of the Commercial Club; J. A. Buck, Sr., President of the Honolulu Plantation Company; J. Hooper, Vice President of the First Federal Trust Company; B. D. Dean, Assistant Cashier of the Crocker National Bank; R. B. Woolverton, United States Radio Inspector; Thomas P. Boyd, District Attorney of Marin County; M. J. Pedrotti, President of the Board of Supervisors of Marin County; F. A. Kolster, Assistant Physicist of the Department of Commerce; Mr. Gardner, Supervisor, Marin County; John D. McKee, President of the Mercantile National Bank; A. W. Foster, Secretary of the Panama-Pacific International Exposition; A. W. Foster, Jr., President of the Marin County Water Company; C. A. Horn,

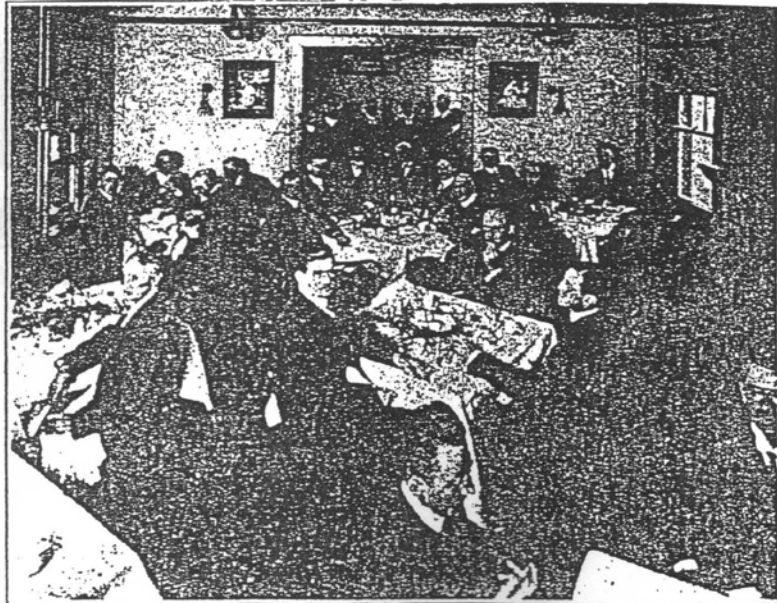

BOLINAS, MARCONI HOTEL

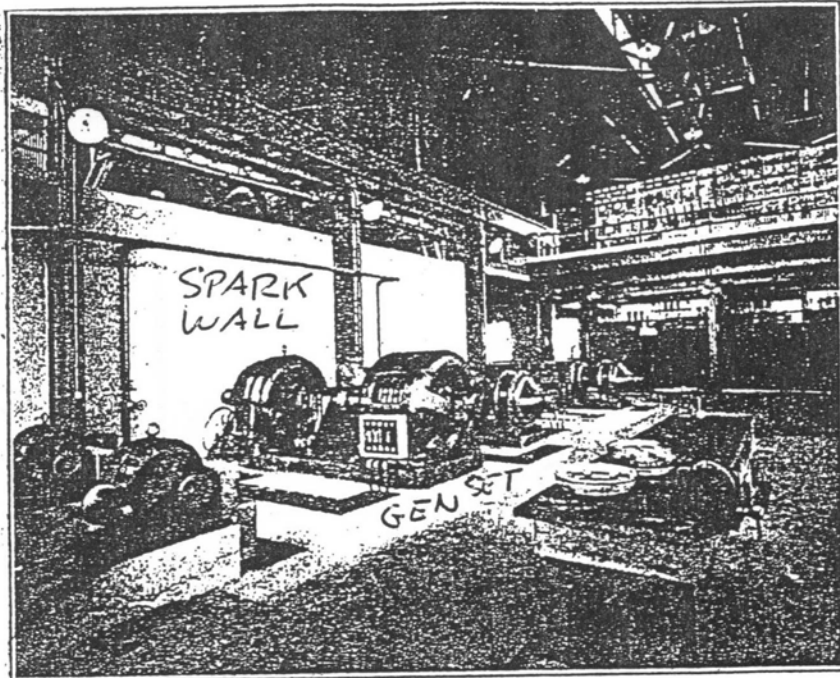

Interior of the transmitting station of the great Marconi trans-Pacific plant at Bolinas, Cal.

EAST SIDE  
LOOKING NORTH

FIG  
3A

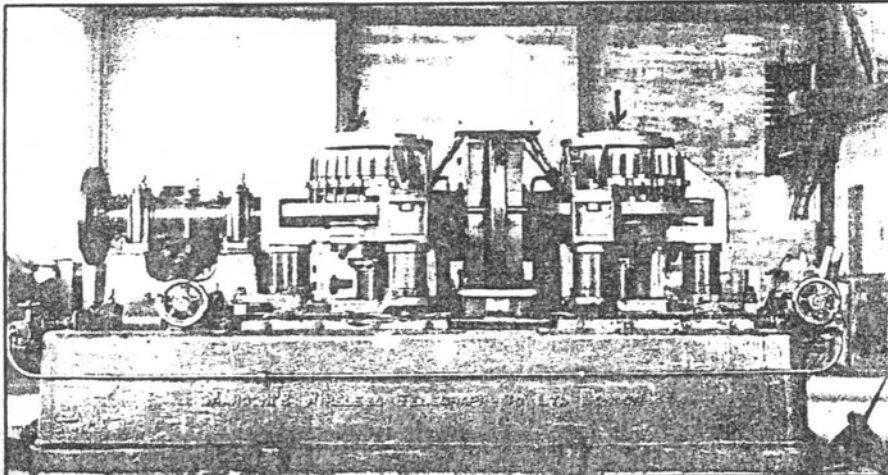

Fig. 24. Marconi 300-kW synchronous rotary gap, station KET, Bolinas.

NOT YET ON SITE



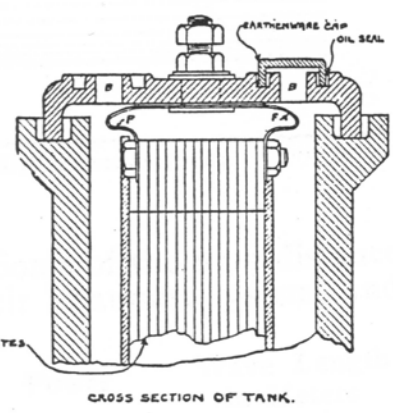
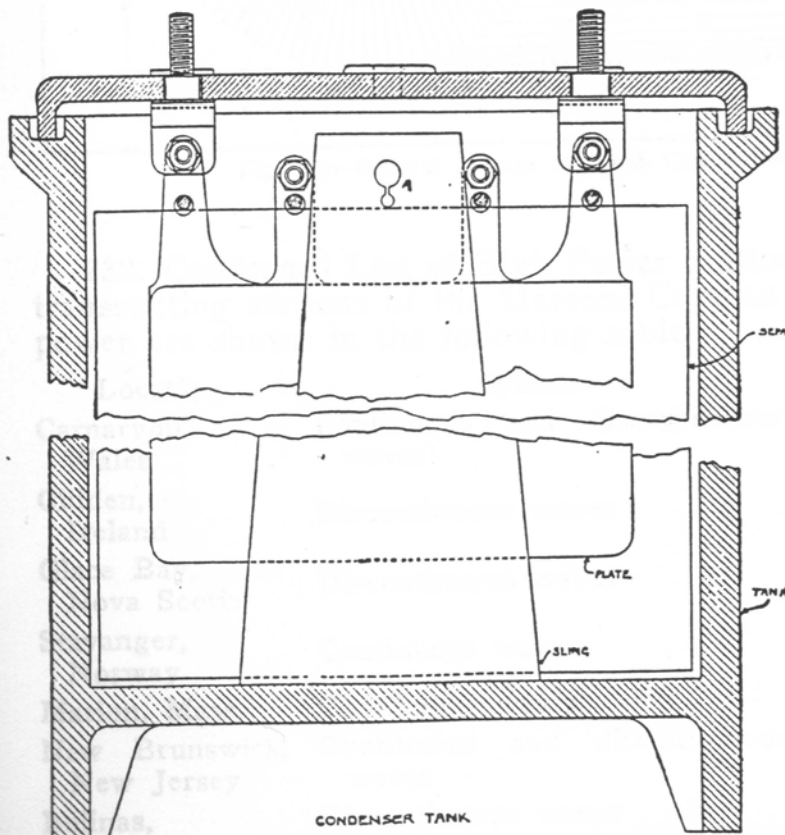
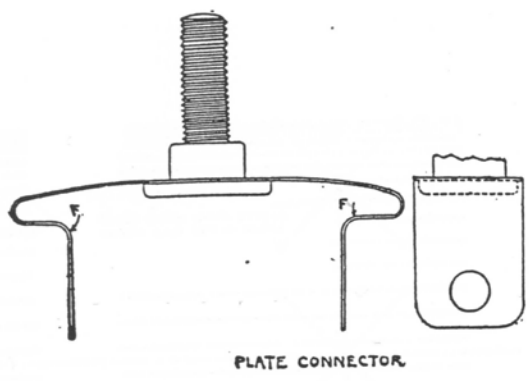
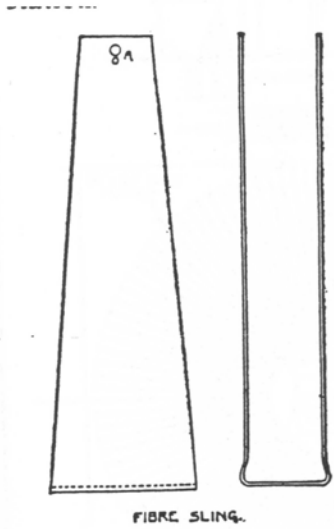

Fig. 319—Details of Condenser Tanks for High Power Stations.

# GROUND WIRES AROUND POWERHOUSE

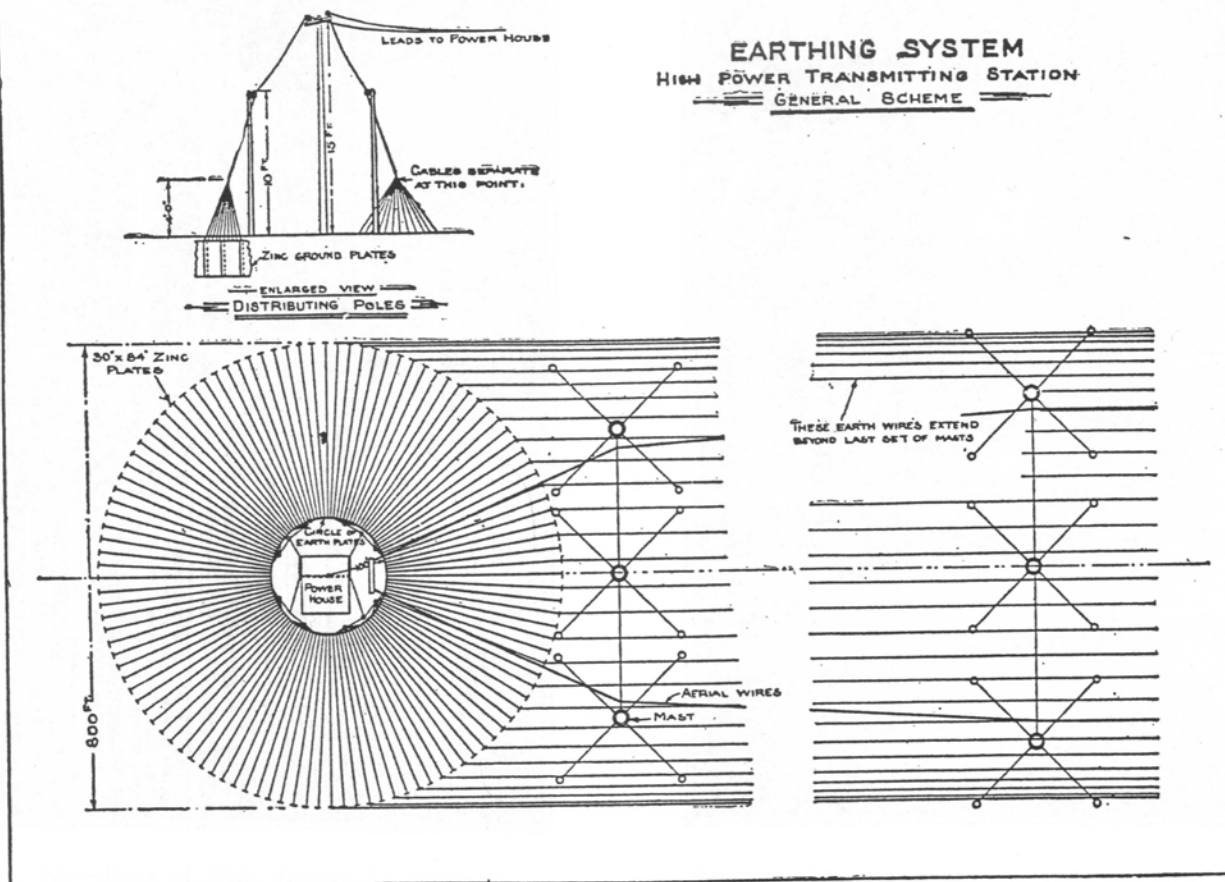

Fig. 320—General Scheme of Earth Connections for High Power Stations.

239. Condensed List of High Power Stations.—Some of the long distance transmitting stations of the Marconi Company, their locations, systems and power are shown in the following table:

Location	System	Power	Wave Length in Meters
Carnarvon, Wales	Continuous and discontinuous waves	100-300 K.W.	6,000 to 10,000
Clifden, Ireland	Discontinuous waves	75-150 K.W.	5,500
Glace Bay, Nova Scotia	Discontinuous waves	75-150 K.W.	8,000
Stavanger, Norway	Continuous waves	150 K.W.	?
Marion, Mass.	Continuous waves	150 K.W.	?
New Brunswick, New Jersey	Continuous and discontinuous waves	150-300 K.W.	8,000 to 15,000
Bolinas, California	Discontinuous waves	300 K.W.	6,000 to 10,000
Kahuku, Hawaii	Discontinuous waves	300 K.W.	6,000 to 12,000

STATION LIST



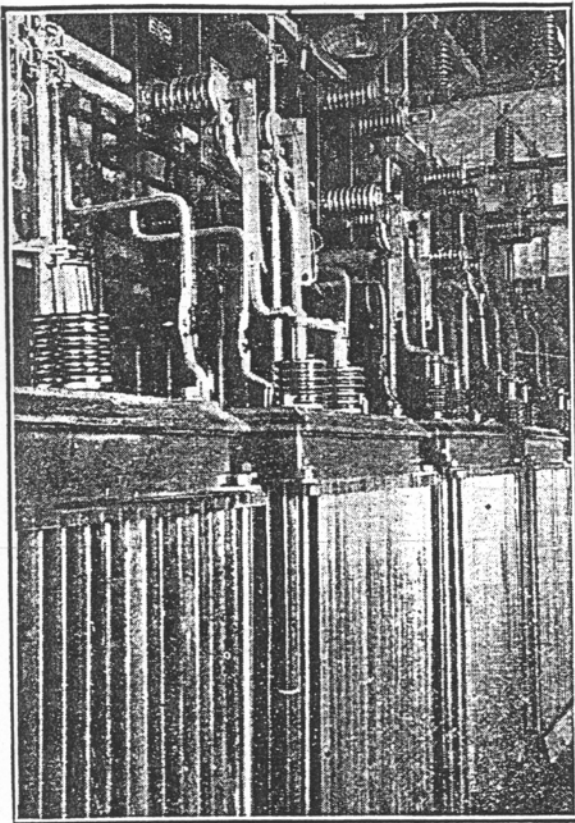

Fig. 322—Bank of High Voltage Transformers at Kahuku.

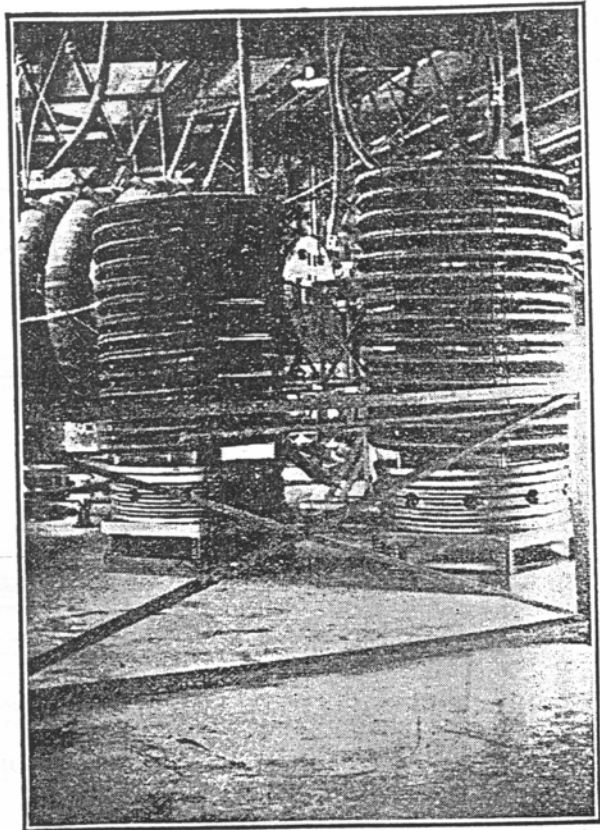

Fig. 321—The Aerial Tuning Inductances at Kahuku High Power Station.

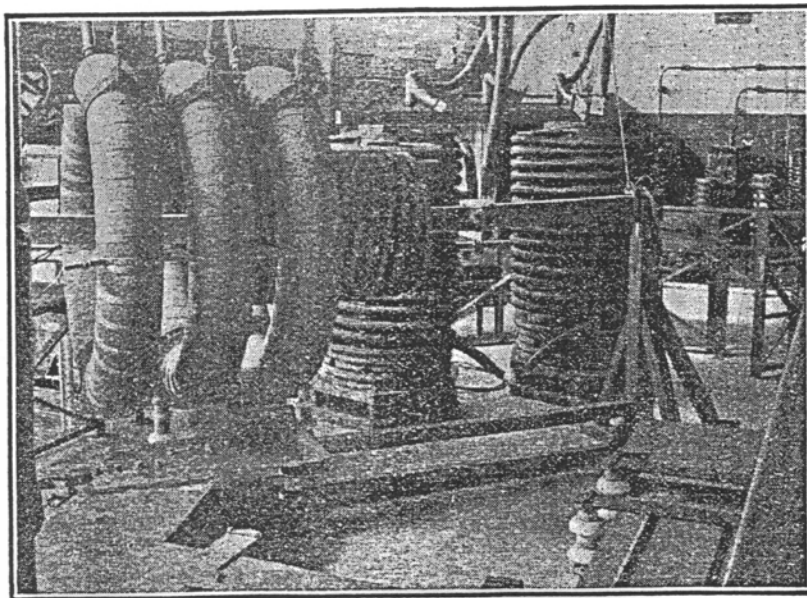

Fig. 318—The 300 Kilowatt Oscillation Transformer Installed at the Marconi High Power Station at Kahuku, Hawaiian Islands.

ITEMS  
EQUIVALENT  
TO BOLINAS SITE

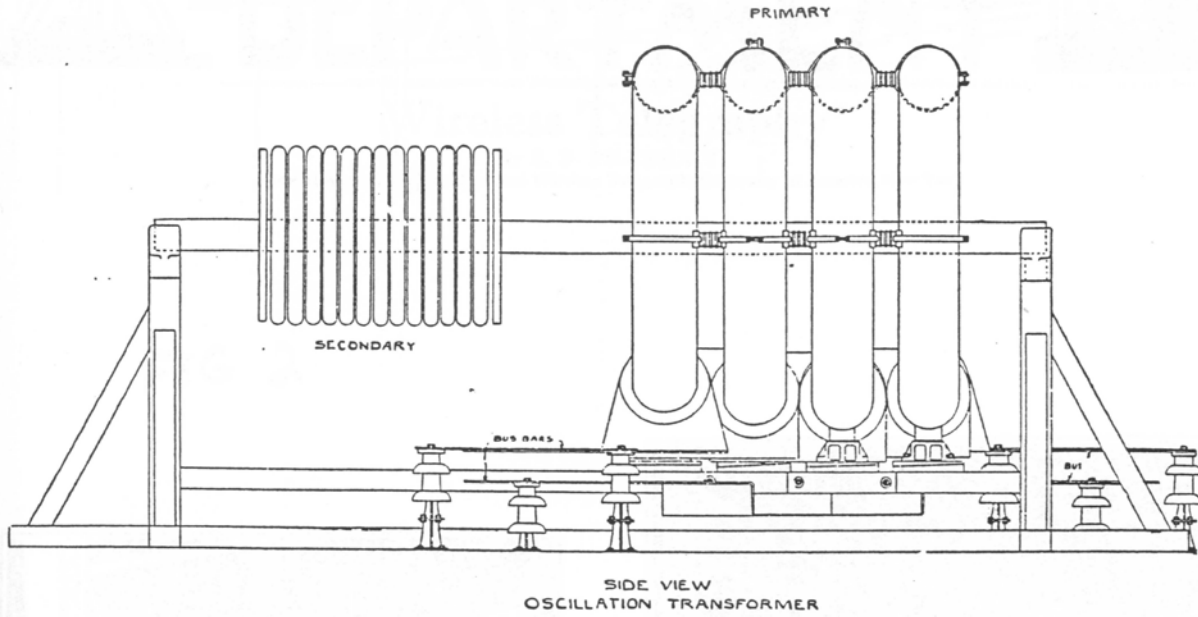

Fig. 316—Side View of 300 Kilowatt Oscillation Transformer.

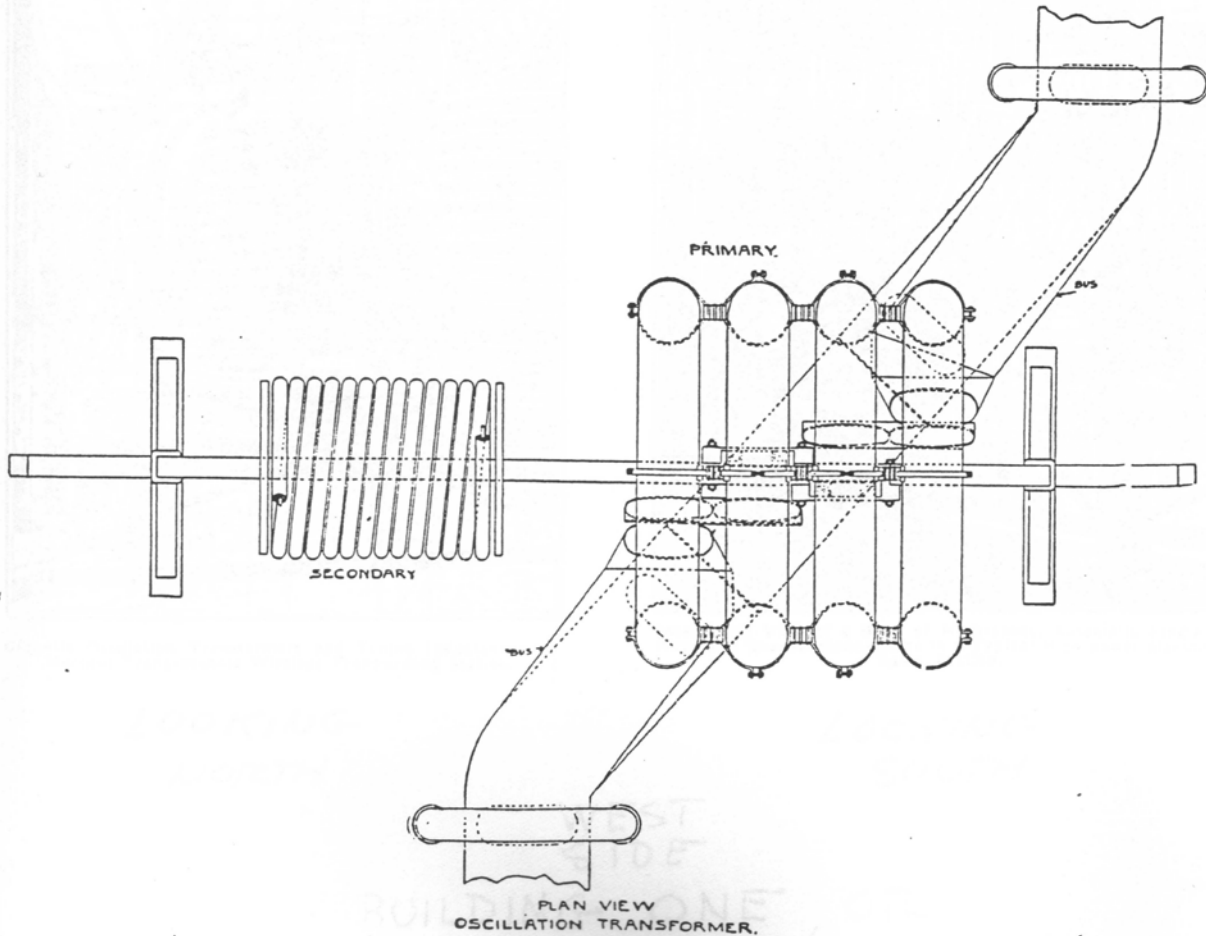

Fig 317—Plan View 300 Kilowatt Oscillation Transformer Showing High Tension Bus-Bar.





# RADIO DEPARTMENT

## Wireless Telegraphy\*

By E. B. PILLSBURY

General Superintendent, Marconi Wireless Telegraph Company of America, New York

FIG 2

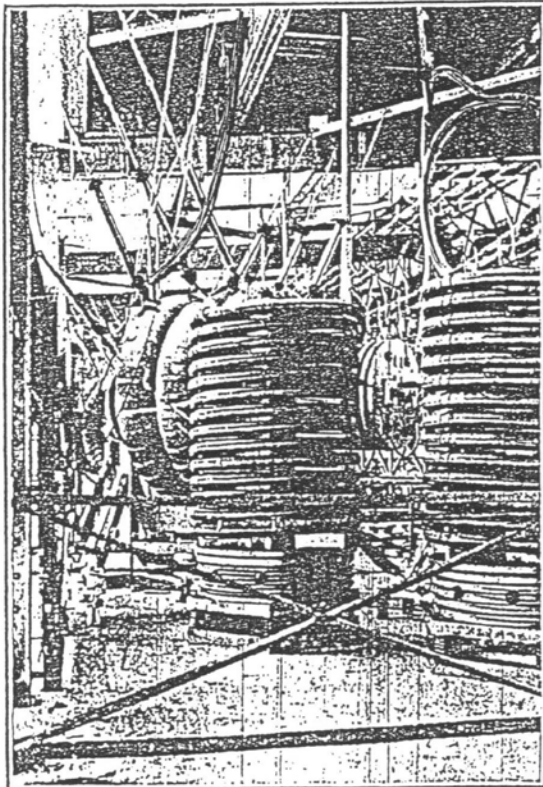

Gigantic Oscillation Transformers and Tuning Inductances In Marconi Trans-oceanic Wireless Transmitting Station.

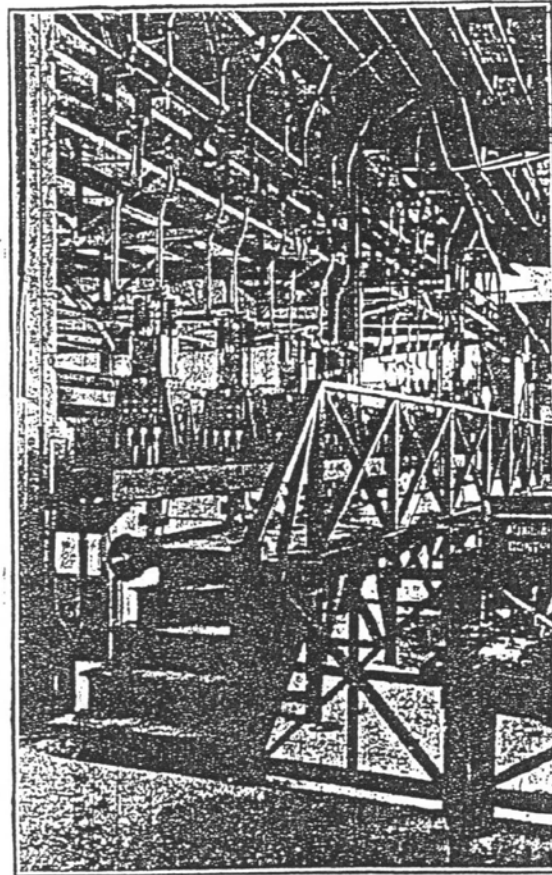

Interesting View of a Bank of High-speed, Automatic Sending Keys and Bus-bar Connections In a Typical High-power Marconi Radio Station.

LOOKING NORTH

LOOKING SOUTH

WEST SIDE

BUILDING ONE, OR "MARCONI POWERHOUSE"

//



MARCONI POWERHOUSE  
TODAY



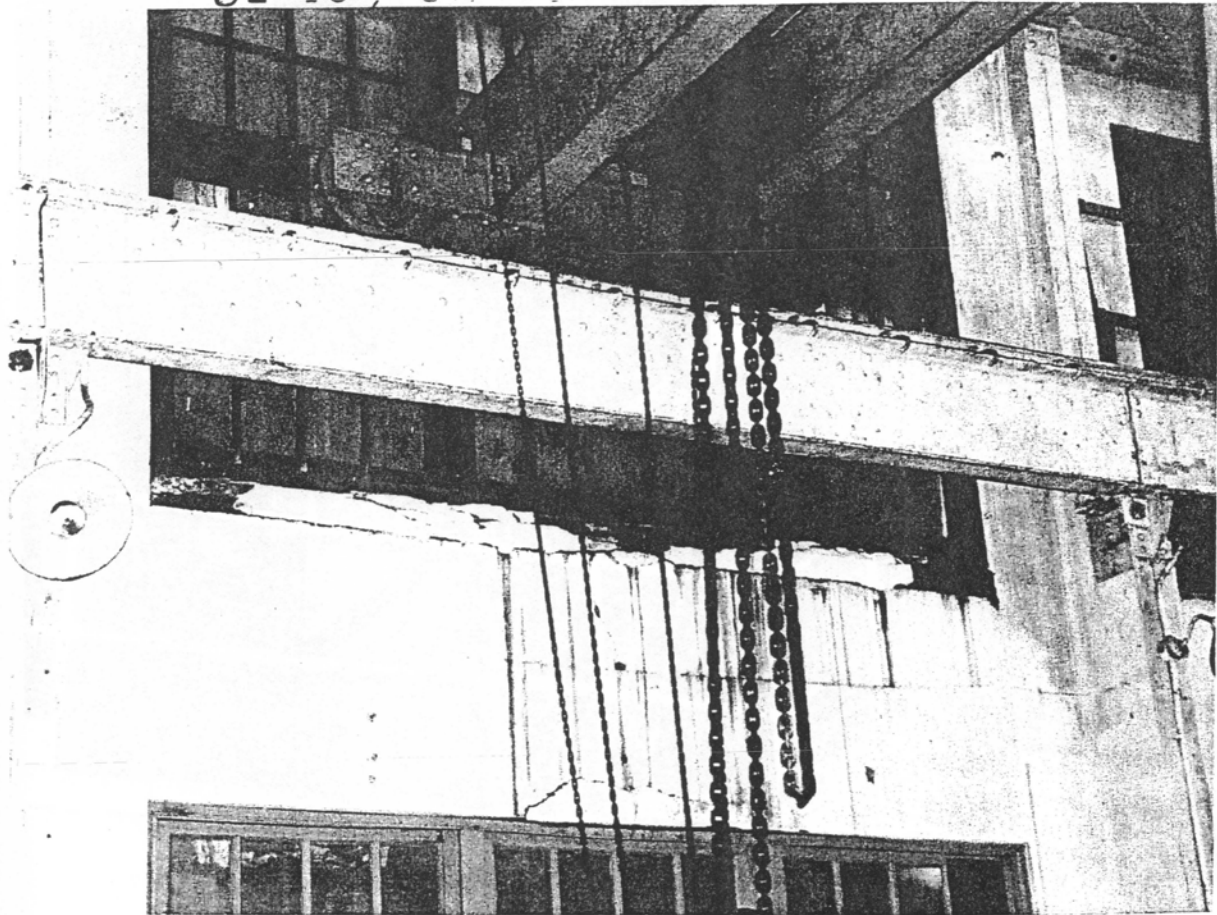

POWERHOUSE INTERIOR

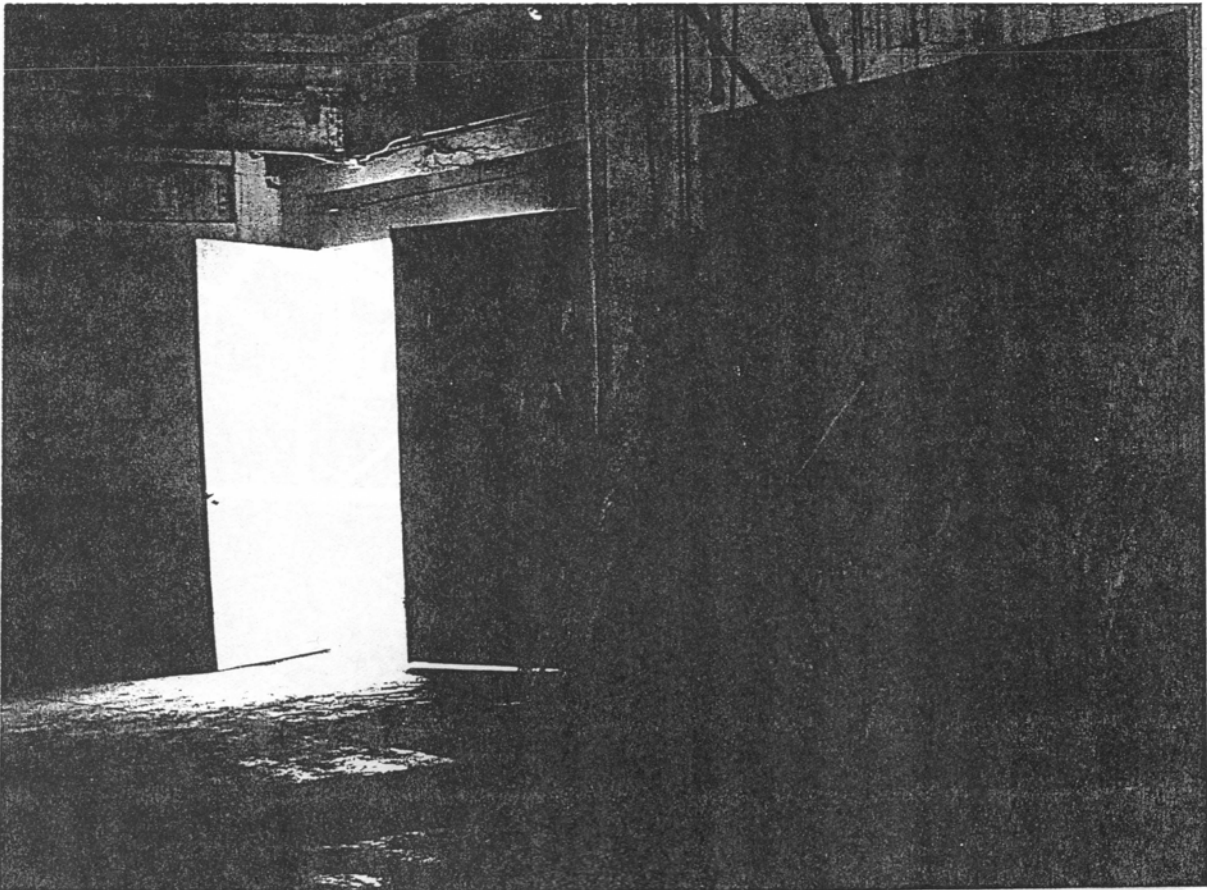



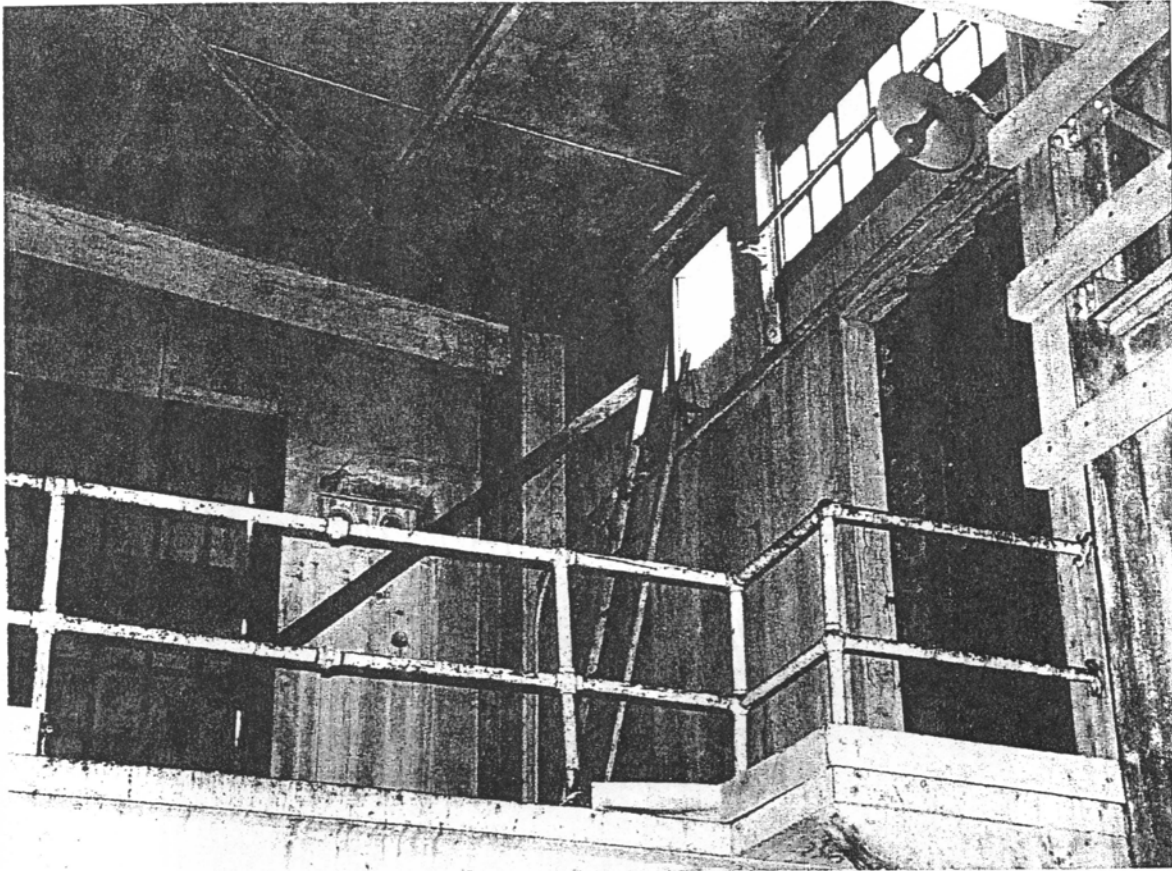

MARCONI BLDG, BL-1 LOCATION

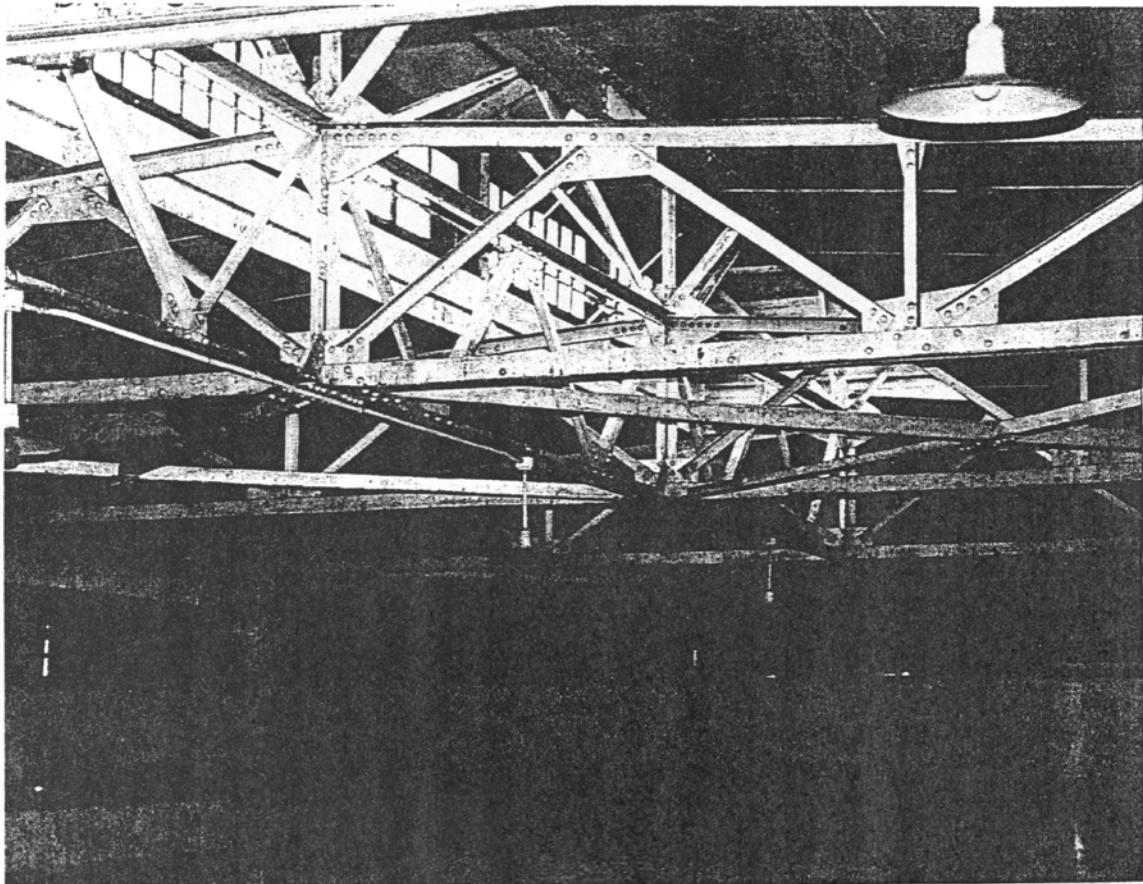

MARCONI BLDG. OVERHEAD STRUCTURE



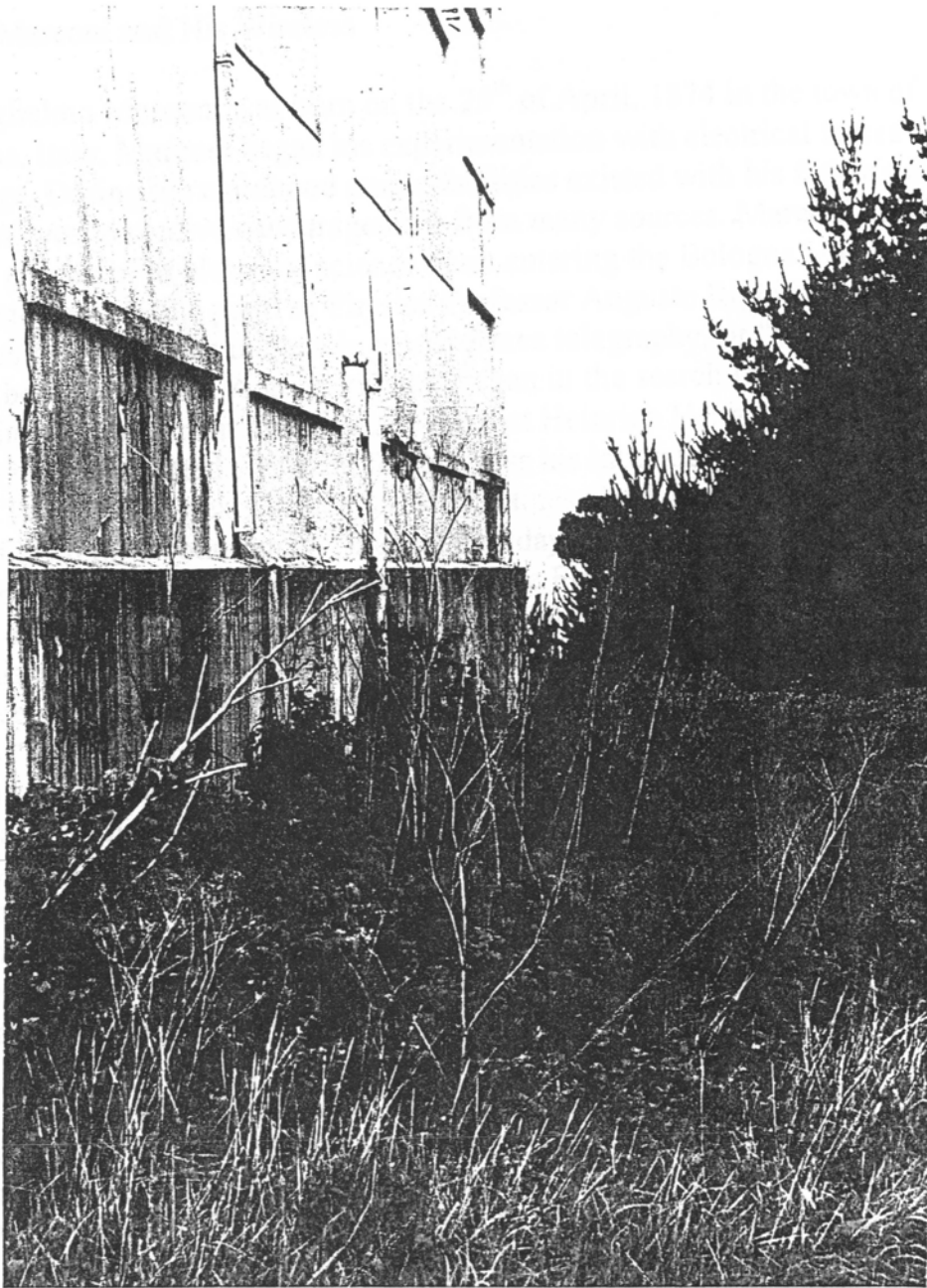

REAR OF MARCONI BLDG  
OVERUN BY WEEDS & STICKERS

## **Chapter Two**

### **Marconi and His Wireless**

Author Commentary: pages 51 - 56

Historic Documents: pages 57 - 89



## II) Marconi and His Wireless

1) Guglielmo Marconi was born on the 25<sup>th</sup> of April, 1874 in the town of Bologna, Italy. Marconi began his experimentation with electrical forces at an early age. During his childhood ample facilities existed with his father's estate and Marconi was to receive encouragement from many sources. Marconi began his formal education in electrical science upon entering the Bologna University. Here he was to become the pupil of Physics Professor Augusto Righi, the Hertz of Italy. Marconi began serious interest in electric wave telegraphy, or "wireless," as it would become known. A great impetus began in the search for wireless waves upon the announcement by German Physicist Heinrich Hertz (1857-1894) in 1888 that he had transmitted electrical force across his laboratory with no connecting wires. Twenty-four years before, in 1864, James Clerk Maxwell, following the path of his fellow countryman Michael Faraday, published his famous paper: "On the Dynamical Theory of the Electromagnetic Field." Maxwell theorized that so-called empty space was filled with a primordial medium called the aether. He felt that this aether could carry electricity through space in the form of an electric displacement current, this to be taken up 30 years later by Tesla. Maxwell found that the ratio of the electrostatic to the electromagnetic character of the aether was dimensionally and numerically equivalent to the velocity of light. This proposal shocked the scientific community and the search for the electric light waves of Maxwell's theory was to begin. The findings of Hertz were eagerly accepted as the Laminar, or Transverse Electromagnetic Waves of Maxwell and his theories. The Italian scientist Augusto Righi was to become a foremost researcher of Hertzian Waves, as they became known. His young student, G. Marconi, was to gain firsthand knowledge of Hertzian wave behavior.

2) Marconi, to his dismay, was to find Hertzian waves unsuitable for any practical wireless endeavor. The Serbian immigrant Nikola Tesla (1856-1943) publicly declared that Hertzian waves were not the sought after Laminar Waves of Maxwell. After a visit from Tesla, Hertz was to withdraw part of his theory, but his untimely death in 1894 at age 37, prevented the completion of his efforts. Tesla would stun the world with his public demonstrations of his experiments with electric waves. Electric lamps held in his hands would light brilliantly anywhere in the hall, with no connecting wires. Tesla's own body would glow like a neon anode, giving the appearance of his being on fire. Many viewers ran from the hall in terror. The 19<sup>th</sup> century was not prepared for the 21<sup>st</sup> century technology of Nikola Tesla. Obvious to all was that here lay the key to any functional wireless endeavor.

Marconi travelled to Tesla's New York City laboratory to witness his methods of transmission firsthand. The unsuspecting Tesla was all too eager to share his

discoveries with Marconi, not knowing Marconi would take it on his own without Tesla. Marconi was quick to adopt the resonant transformer and displacement current transmission system devised by Nikola Tesla. The Hertzian methodology was abandoned. The Tesla system consisted of an aerial structure called an elevated capacity, and an earthed structure called a ground. The displaced electric fluid transferred from the earth by the resonant (or "Tesla") transformer was held by the electrostatic capacity of the aerial structure. The aerial radiated no electromagnetic waves but transmission was effected by the movement of displaced electricity within the earth, or globe. In other words, transmission to a distant receiver is through the interior of the globe, not through the space surrounding it. The wireless engineers of Marconi's time were of a Hertzian mindstate, thus Marconi was to proceed along the lines of radiation through space by the aerial. The significance of the earth currents was to gradually be forgotten. Experimental structures were devised by Marconi, utilizing grounded aerial capacities. He was to miss the importance of proper resonant transformer relations to the elevated structure and earthed connection, this resulting in weak and ineffective transmissions. Marconi's first functional stations were to appear between the years of 1900 and 1901. Having successfully established limited ship-to-shore contacts, Marconi, at 27 years of age, was ready to attempt his lifelong dream of trans-oceanic wireless communication.

Two sites were chosen, one at Poldhu, Cornwall, UK, and the other at Glace Bay, Cape Breton, Nova Scotia. The giant elevated capacities erected were in the form of 210-foot high inverted pyramids. Great difficulty with gale winds and their damage to his structures led to the use of kites in the manner of Franklin and Loomis. Marconi sailed a kite outfitted with metal screens, 400 feet up in the air at a temporary site in St. John, Newfoundland. He continuously keyed his arrangement at Poldhu with the Morse code letter S (dit-dit-dit) in the hopes that it would be received by his kite aerial across the Atlantic. Marconi claimed to have made contact on December 12, 1901, but some believe the results were faked to allow for more experiments. About the same time his demonstration to Naval authorities was a dismal flop. Marconi would throw his gear overboard in disgust. After similar demonstrations, he still had no wireless.

3) Nikola Tesla, however, continued having success in his wireless endeavors and at the time of Marconi's failure, had demonstrated wireless remote control of model submarines to the Navy, and was on his way to constructing his first commercial wireless plant. Tesla had previously demonstrated his abilities with his design of the Niagra Falls Electrical Generating Facility, the world's biggest at the time. He therefore found no difficulty in procuring funds for his next project, for worldwide wireless transmission of energy and communication, as it would surely work. During the years of 1891 to 1893 Tesla began his investigation into the transmission of electricity without the use of connecting wires. Tesla's aim



was to transmit electrical energy in industrial quantities through the interior of the earth to any location on the globe. This would eliminate the use of electromagnetic power lines. The sheer magnitude of such an engineering endeavor would make the mere transmission of telegraph signals insignificant, so Tesla staged no such event.

This would lead to his demise, as Marconi claimed to span the Atlantic during Tesla's construction, creating uncertainty in the minds of the investors. The wireless experiments of Tesla were to pre-date Marconi by ten years. The Tesla system of concatenated tuned circuits is the very foundation of today's radio technology; it would not work without it. Tesla had patented every wireless device, the hydrogen arc, the disruptive condenser discharge, the rotary gap, the resonant transformer, the oil condenser and the aerial ground structure. Any improvement was not likely. After the turn of the century wireless experimenters flourished and by 1905 many established stations existed, notable being the De-Forest PH, later to become KPH Bolinas. Others were Murgas, Fessenden, Massie and Marconi, to name but a few. Conflicting theories prevented any significant scientific development. The electromagnetic theory of Maxwell was to dominate, thereby clouding any real understanding of electric wave telegraphy, or wireless, as it became called. What followed were erroneous theories and constant patent litigation. Everyone claimed an improvement upon the Tesla system, resulting in hundreds of patents on the same thing. This served to diffuse Tesla's priority in wireless. The rush was on, leaving Tesla behind, along with the 19<sup>th</sup> century. He was to be too far ahead of his time.

4) These events would serve Guglielmo Marconi well and he would pick up where Tesla had left off, but without full comprehension of how it all worked. Tesla was a scientific discoverer, Marconi was an experimenter and promoter. He would adopt selected apparatus of Tesla's designs and re-work them in his endeavors. Tesla's rotary break condenser discharge and his resonant transformer (Tesla coil) were to be at the heart of every wireless station in existence at the time, but these would not be operated in the manner prescribed by Tesla. Marconi began the purchase of his competing stations, such as those of United Wireless, American De-Forest and Massie. Marconi also started a process of patent acquisition, purchasing those of Murgas and Edison to name a few. His only competitor was Reginald Fessenden, the leading wireless pioneer of the time. Marconi was no longer the experimenter of his youth but now was the promoter of wireless. The Marconi Wireless Telegram Co. of America was to grow from insignificance into a virtual monopoly. By 1914 he had completed his great New Brunswick facility as well as Bolinas and Kahuku. He had been awarded the Nobel Prize in 1909 and was to be known as the "Father of the Radio." At the age of forty, his lifelong dream of worldwide wireless became a reality.

5) Massive investments of capital were required for global power stations like those of Tesla and Marconi. These were no 5 kilowatt affairs, but utilized hundreds of kilowatts. Their elevated capacities were equivalent to bridge building projects. Such endeavors seemed as science fiction to investors, but the possibilities were fantastic. Tesla's undertaking at Long Island, New York, was a full-sized power station with a potential of 100 million volts. Marconi's stations such as New Brunswick or Bolinas would have hundreds of mega-watts circulating in their massive aerial-ground structures. The powerhouses were the size of small great cathedrals. To acquire funding for such projects required intensive promotional efforts. While the system of Tesla far surpassed the relatively weak one of Marconi, Tesla's system possessed certain risks in the minds of the capitalists. The entire industrial establishment of the time was solidly rooted in the work of Edison (D.C.) and that of Tesla (A.C.). The electrical industry thus created stood alongside the steel and railroad industries. Tesla was now constructing a radically new electrostatic technology (that of the 21<sup>st</sup> century). He stated it would send the heat engines of the world to the scrap heap (coal and oil). But wait: the technology that he and Edison had developed was barely 15 years old. Marconi, on the other hand, was not the idealistic discoverer that Tesla was, but had a more ~~scientific~~ <sup>specific</sup> plan in mind. Tesla had achieved his dream of harnessing Niagra Falls; Marconi would seek his dream of worldwide wireless. The world would not be provided with electricity, but telegrams. Funding for Tesla's Long Island plant was quickly withdrawn and Tesla faded into invisibility. A great void had now been created and in a few years Marconi would fill it. By 1910 the established Marconi power station would appear. However, as with Edison, Tesla, Thompson and so many others, Marconi was to find his operation to quickly outgrow him. Major engineering difficulties were encountered with the new electrical forces of the power plants. Corporate operations greatly complicated the basic aims of Marconi, and on top of it there were the Tesla patent suits. With the threat of world war looming, Marconi's foreign status would further damage him. On April 9, 1917, three days after the outbreak of war, the U.S. Navy issued the following order (in part): "Pursuant to the president's war proclamation, all radio stations of all classes are hereby ordered closed and dismantled immediately, except such stations as are specifically to remain in operation under competent military authority...." Marconi was shut out of his own operation. Also, because of an appeal by President Wilson, Marconi would be sold no more wireless equipment, for fear of foreign control. In 1918, at war's end, Marconi's commercial manager, David Sarnoff, announced that the U.S. Navy had purchased 45 of American Marconi's stations. Bolinas, California, New Brunswick, New Jersey and Marion, Massachusetts were to be returned to Marconi. Official approval came from President Wilson in July of 1919, effective March of 1920. The Navy became very concerned about Marconi obtaining the rights to General Electric's Alexanderson system and in October, 1919, formed the Radio Corporation of America to take



control of the New Brunswick series stations. The assets of American Marconi, worth 3.5 million, were purchased by G.E. and turned over to R.C.A. American Marconi dissolved on April 6, 1920. Marconi, at age 47, drifted out to sea in a self-imposed exile, still haunted by Tesla.

6) Sailing the world in his yacht Elettra, a floating laboratory (fig. 14), Guglielmo Marconi would return to the electrical experimentation of his youth. He had lost his empire but not his fame. Marconi began experiments with short electromagnetic waves (shortwave), these being the true Maxwellian waves. Unlike the massive high voltage structures of his long wave electrostatic wireless stations, the short electromagnetic waves used small structures (fig. 15). The cost of experimentation was therefore also small. These new waves could be focused, reflected, and refracted exactly, as with waves of light. These experiments served as the final verification of the electrical "light waves" of J.C. Maxwell's theory.

Around the turn of the century a theory of an upper atmosphere of electricity, surrounding the meteorological atmosphere of the earth, began to take form. Principle were the writings of A. Kennelly and O. Heaviside, and the experiments of N. Tesla and R. Fessenden (fig. 15a). Fessenden had set up an elaborate system (fig. 13) to prove its existence, and Tesla patented the use of this atmosphere for the transmission of electrical power without the use of connecting wires (fig. 15b). This electrical atmosphere would be known as the Kennelly-Heaviside layer in early years, and after various space probes testing its existence it became known today as the ionosphere, an atmosphere of rarefied, ionized gas extending from 50 to 250 miles above sea level.

Marconi undertook experimentation with the refraction of shortwaves through this medium so as to carry these waves to great distances, similar to shining a light upon the surface of water at such an angle as to get it to refract beyond the surface. His experiments with the Maxwellian waves and the ionosphere were a tremendous success. ~~The~~ ~~thing~~ ~~was~~ ~~that~~ ~~the~~ ~~influence~~ ~~of~~ ~~the~~ ~~ionosphere~~ ~~with~~ ~~his~~ ~~electrostatic~~ ~~wireless~~ ~~was~~ ~~one~~ ~~of~~ ~~his~~ ~~major~~ ~~problems~~. Thus a new system of wireless was born: shortwave radio. This cheap and easy system was quickly to fall into the hands of amateur radio experimenters. With the use of the new De-Forest audion and the regenerative circuits of Armstrong, unheard of frequencies of 100 million cycles per second were attained by Marconi and the "Hams." It was not long before the amateurs, or "Hams," as they became known, were making trans-Atlantic contacts through the use of simple shortwave apparatus. Guglielmo Marconi, at age 50, would again achieve his fame as the Father of Radio.

7) To suit the needs of the Dollar Lumber Company, later to grow into the Dollar Steamship Line, Captain Robert Dollar commissioned the Heintz-Kaufmann Company of San Francisco to test the work of the Hams. Ralph Heintz was the radio tube whiz of the time. The Dollar company was tired of the high cost of ship-to-shore message service, thus the interest in the Ham's methods of cheap but effective long-distance signaling. A new ship-to-shore service was in the making. After a year-long trial, 1928-1929, it was a great success and instantly, the giant stations of R.C.A. became dinosaurs. Marconi's giants that fell to R.C.A. were quite obsolete. Marconi had again done what Tesla could not. These corporate institutions felt that shortwaves were useless for over the horizon propagation because of their light-like nature. The shortwave spectrum below 200 metres was given to the Hams. "They will never get out of their back yards with that," joked the experts. Marconi proved this wrong. The Hams made it work and Dollar commercialized it. R.C.A. was taking note of this at its beginnings and was preparing for new shortwave facilities, receiving its first transmitter in 1924, the Type B. By the late 1920s the bulk of the shortwave spectrum was taken from the Hams. R.C.A. was to be given some 25,000 shortwave frequencies. The great wireless plants were demolished. Marconi would fade from view during the following years, leaving a British communications equipment company bearing his name. He died in 1937, forgotten in technical circles, but forever to be known as the Father of Radio.

Letter to Edward J. Nally, President  
Radio Corporation of America  
January 10, 1920

While dealing with the subject of transmission and reception on shortwaves, I might record a hunch which I have held for some time and which I have discussed with a number of radio engineers, who, I should say in justification of their opinions, definitely disagree with me. I refer to the possibility of employing shortwaves for long-distance communications and, perhaps eventually, transoceanic communications. The obvious answer to this is that daylight absorption makes impractical the use of shortwaves over long distances, but I doubt whether a careful and exhaustive research has been made on this point. Perhaps extreme amplification, such as is possible with the Armstrong amplifier, or even greater amplification, which should be possible, may detect radio signals from shortwaves where present-day amplification fails to do so. The advantages of employing shortwaves over long distances are, of course, well known to engineers, who recognize that greater freedom from static and station interference is possible when employing shortwaves.

(Book: *Radio and David Sarnoff*, by E. E. Bucher, part 1,  
p. 251.)





*J. Clerk Maxwell*

[14] James Clerk Maxwell (1831-79).



[1] Michael Faraday.

1791 - 1867

---



---

ABSTRACT OF PAPER 'A DYNAMICAL THEORY OF  
THE ELECTROMAGNETIC FIELD'

[27 OCTOBER 1864]<sup>(1)</sup>

From the *Proceedings of the Royal Society*<sup>(2)</sup>

A DYNAMICAL THEORY OF THE ELECTROMAGNETIC FIELD<sup>(3)</sup>

By Professor J. Clerk Maxwell, F.R.S.

Received October 27, 1864

(Abstract)

The proposed Theory seeks for the origin of electromagnetic effects in the medium surrounding the electric or magnetic bodies, and assumes that they act on each other not immediately at a distance, but through the intervention of this medium.

The existence of the medium is assumed as probable, since the investigations of Optics have led philosophers to believe that in such a medium the propagation of light takes place.

The properties attributed to the medium in order to explain the propagation of light are –

1st. That the motion of one part communicates motion to the parts in its neighbourhood.

2nd. That this communication is not instantaneous but progressive, and depends on the elasticity of the medium as compared with its density.

The kind of motion attributed to the medium when transmitting light is that called transverse vibration.

An elastic medium capable of such motions must be also capable of a vast variety of other motions, and its elasticity may be called into play in other ways, some of which may be discoverable by their effects.

One phenomenon which seems to indicate the existence of other motions than those of light in the medium, is that discovered by Faraday, in which the plane of polarization of a ray of light is caused to rotate by the action of

---

1 The date the paper was received by the Royal Society. The paper was read on 8 December 1864: see note 2.

2 *Proc. Roy. Soc.*, 13 (1864): 531–6.

3 Published in *Phil. Trans.*, 155 (1865): 459–512 = *Scientific Papers*, 1: 526–97. Reporting on the paper in a letter to Stokes of 15 March 1865 *Royal Society, Referees' Reports*, 5: 137, William Thomson declared that the paper was 'most decidedly suitable for publication in the Transactions'.

THE PAPER THAT SHOOK  
THE SCIENTIFIC WORLD





FIG 6, YOUNG  
MARCONI



Augusto Righi.  
FIG 7 PROF.  
RIGHI



DR. HEINRICH HERTZ



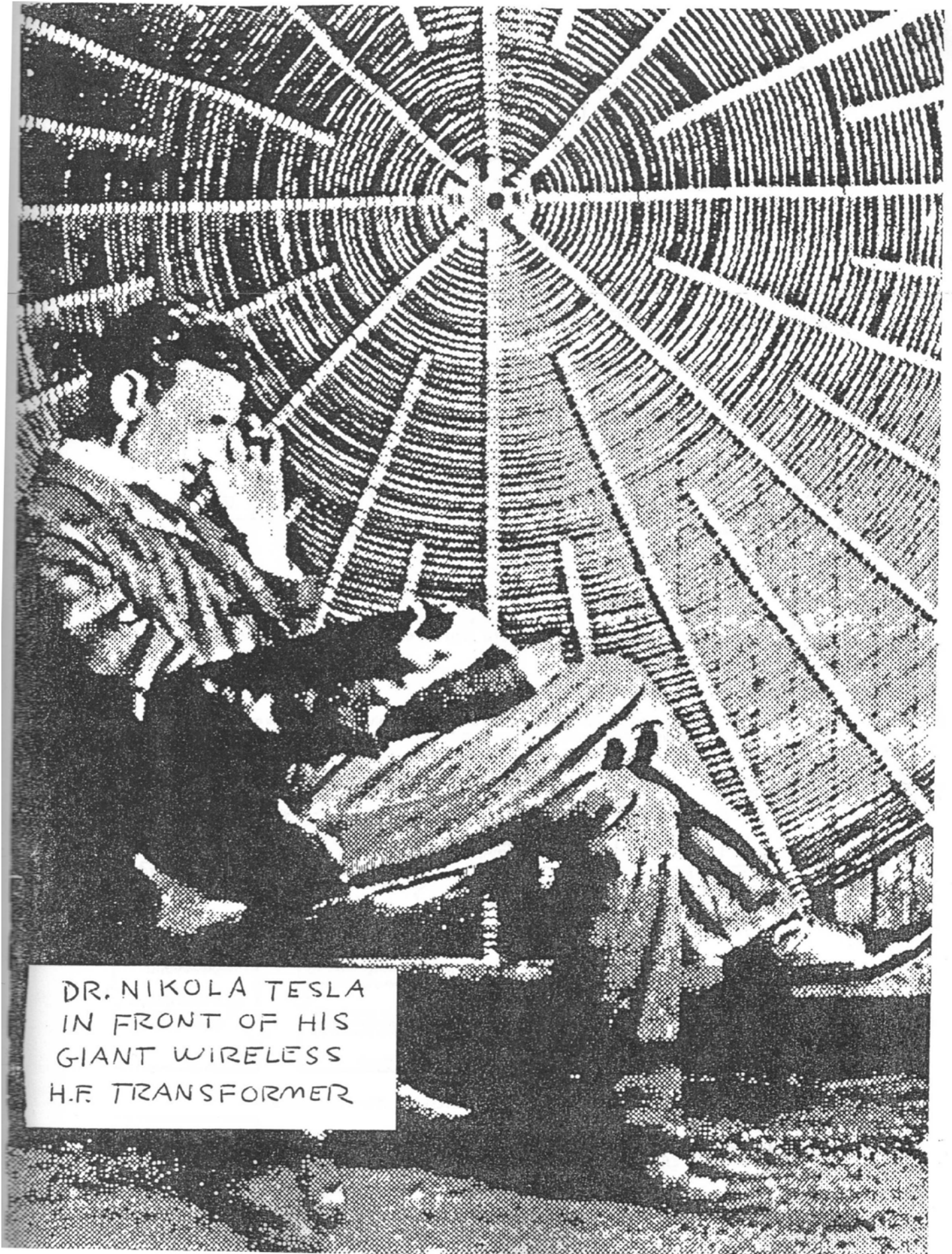

DR. NIKOLA TESLA  
IN FRONT OF HIS  
GIANT WIRELESS  
H.F. TRANSFORMER



THE  
BEGINNING  
OF THE  
WIRELESS

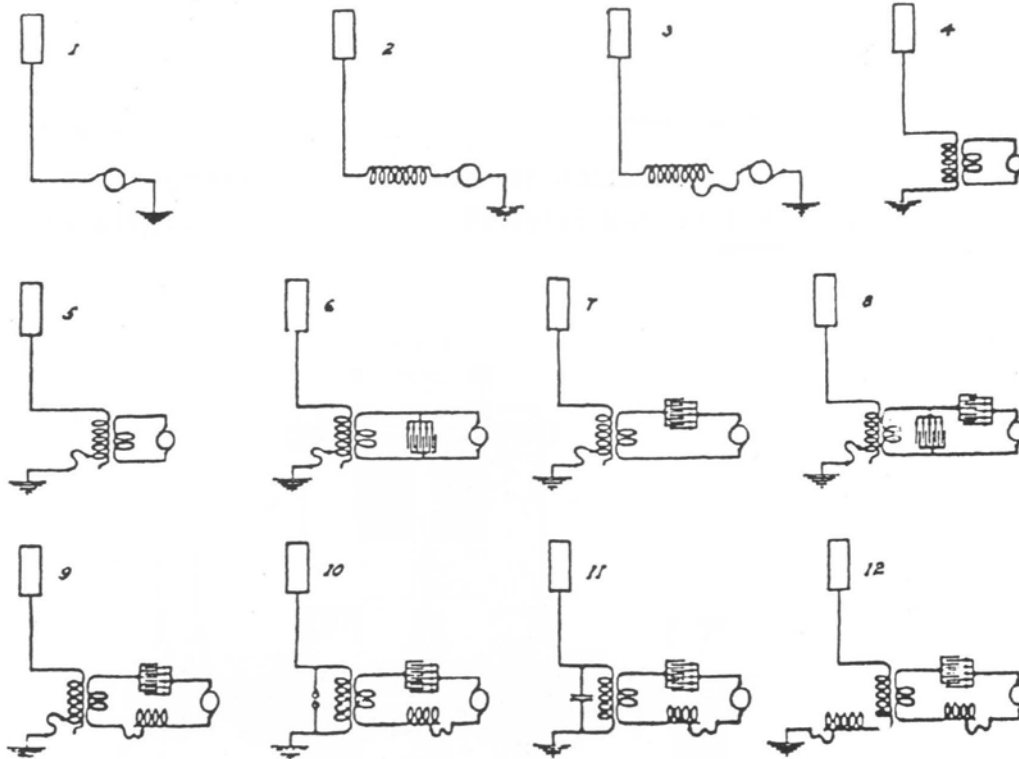

Illustrating various ways of using a high frequency alternator in the first experiments at the Grand Street Laboratory: 1891-1893.

System of concatenated tuned circuits shown and described in Tesla U.S. Patent No. 568,178 of Sept. 22, 1896, and corresponding arrangements in wireless transmission

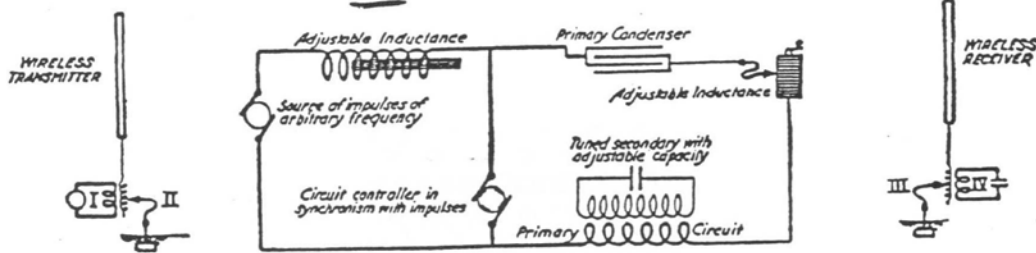

TESLA  
EARLY  
WORK  
IN  
RADIO

THE FOUR TUNED CIRCUITS OF ABOVE DIAGRAM SHOWN SEPARATELY

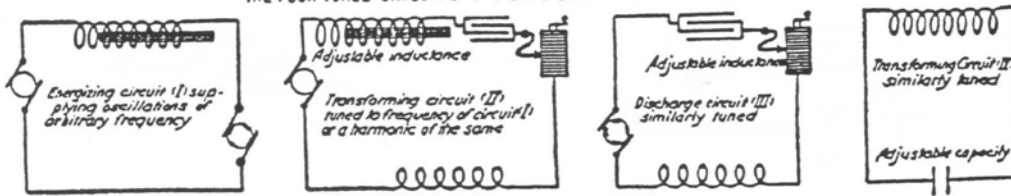

THE CORRESPONDING FOUR TUNED CIRCUITS OF THE WIRELESS SYSTEM

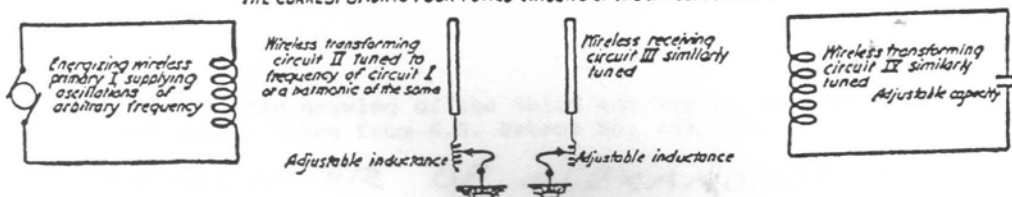

N. TESLA.

ALTERNATING ELECTRIC CURRENT GENERATOR.

No. 447,921.

Patented Mar. 10, 1891.

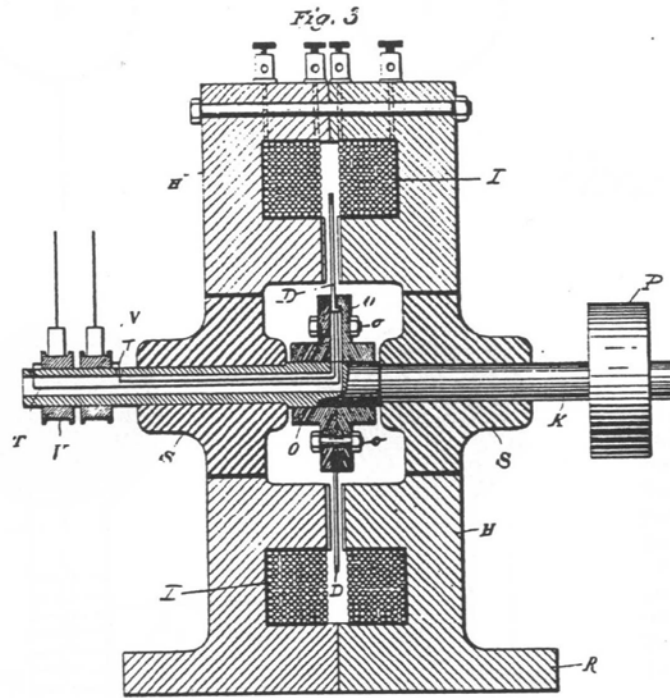

Fig. 4



Witnesses:  
*Cornel S. Johnson*  
*Frank B. Murphy.*

Inventor  
*Nikola Tesla*  
 by  
*Duncan & Page.*  
 Attorneys.

Figure  
 Diagrammatic drawing of the third and larger machine with  
 480 poles, taken from U.S. Patent No. 447,921.

FORERUNNER OF ALEXANDERSON  
 ALTERNATORS



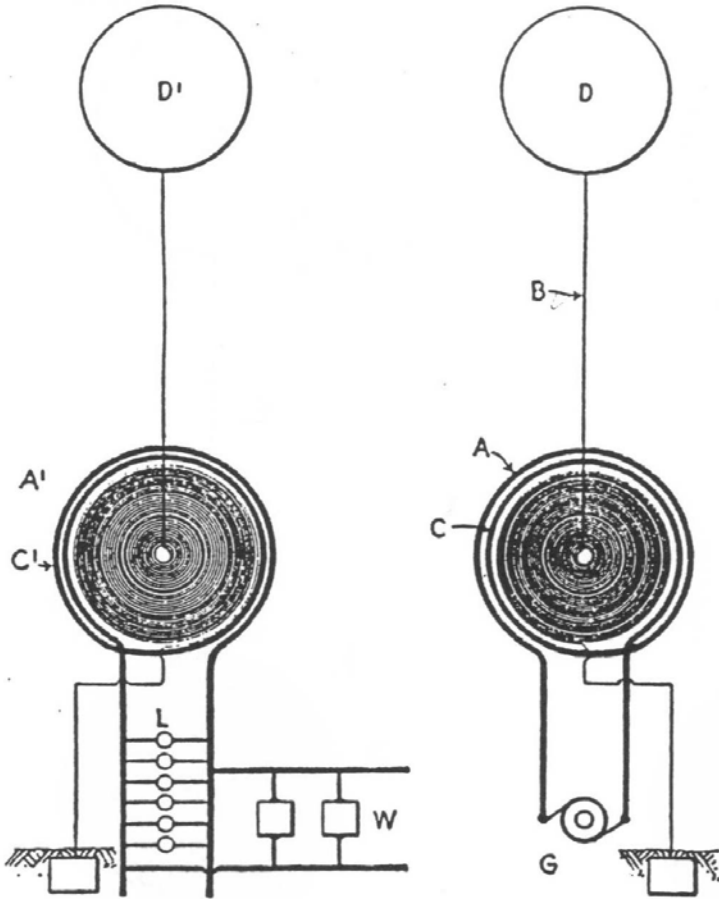

TESLA

Figure  
Diagram showing the  
salient differences  
between the apparatus  
described in these  
patents and the typical  
Hertz wave arrangements  
of that period described  
in the Re-issue Patent  
of Guglielmo Marconi,  
No. 11,913 of June 4,  
1901.

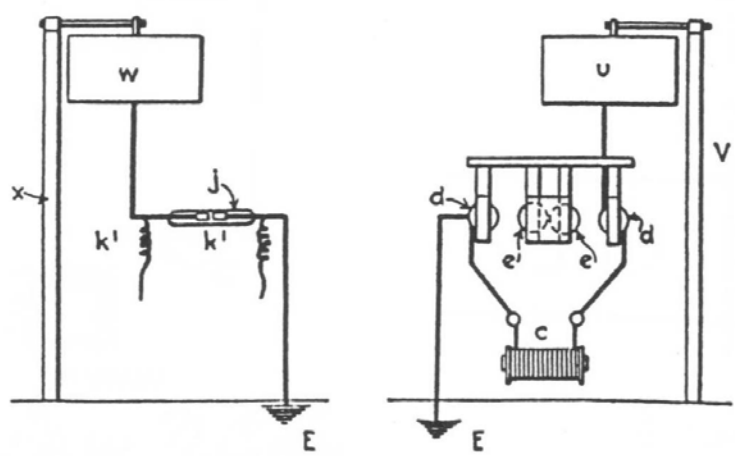

MARCONI

No. 645,576.

Patented Mar. 20, 1900.

N. TESLA.

SYSTEM OF TRANSMISSION OF ELECTRICAL ENERGY.

(Application filed Sept. 2, 1897.)

(No Model.)

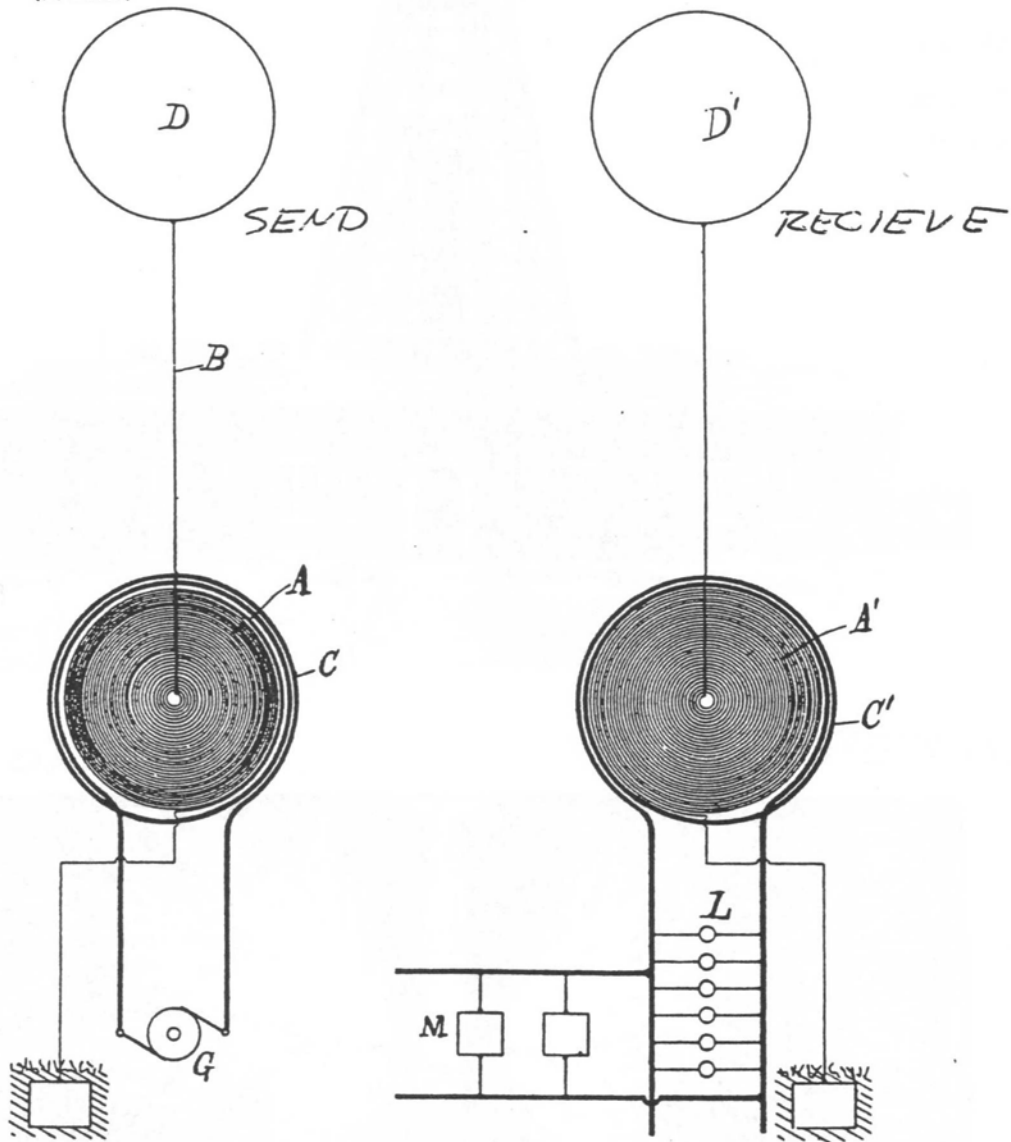

WITNESSES  
*Dwight N. Cooper*  
*M. Hanson*

INVENTOR  
*Nikola Tesla*  
BY  
*Rev. Curtis Case*  
ATTORNEYS.

Figure  
Perfected system of wireless transmission with four tuned circuits.  
Described in U.S. Patent Nos. 645,576 of March 20, 1900 and 649,621  
of May 15, 1900. Applications filed September 2, 1897.



NEW YORK

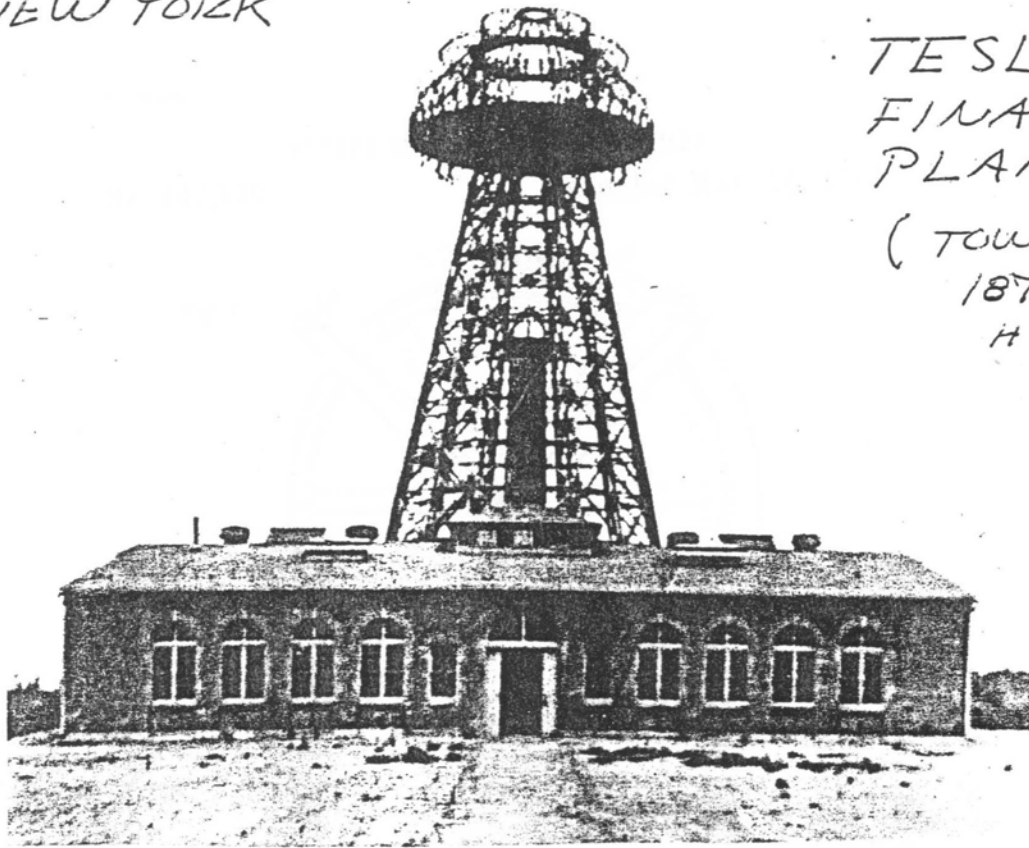

TESLA'S  
FINAL  
PLANT

( TOWER IS  
187 FT  
HIGH )

COLORADO

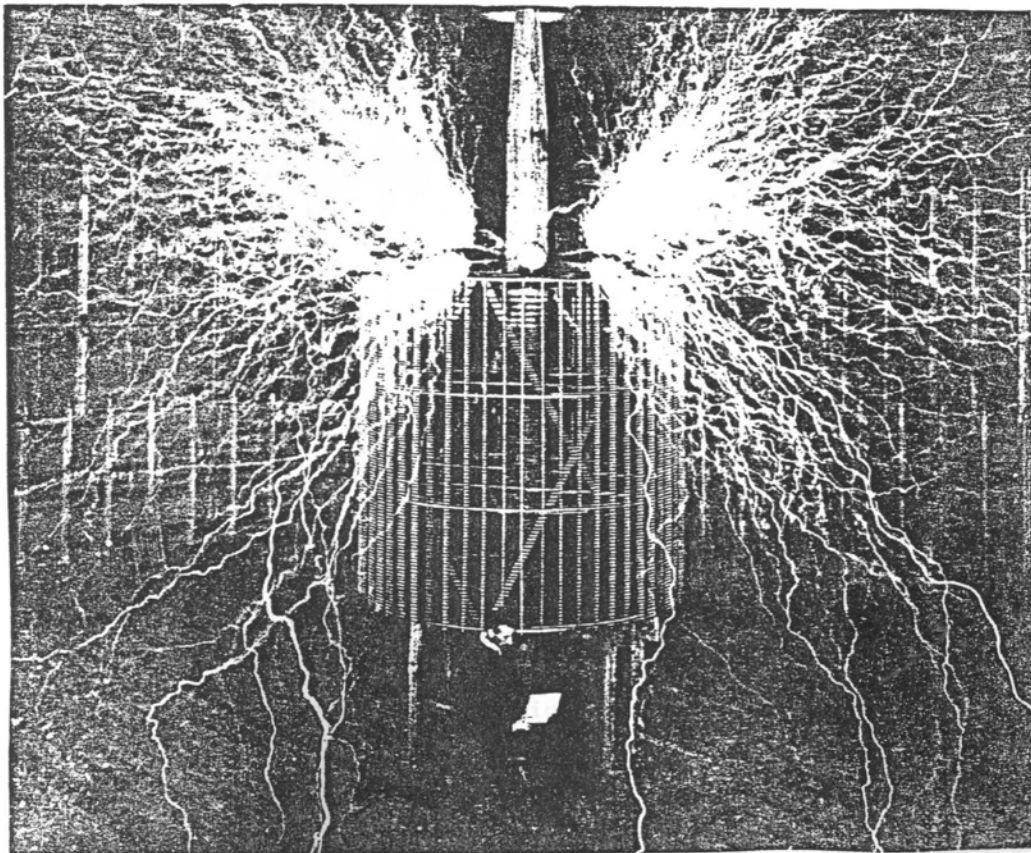

EXPERIMENTAL  
PLANT  
INSIDE

( TESLA  
SITTING  
IN CHAIR )

(No Model.)

N. TESLA.  
METHOD OF OPERATING ARC LAMPS.

No. 447,920.

Patented Mar. 10, 1891.

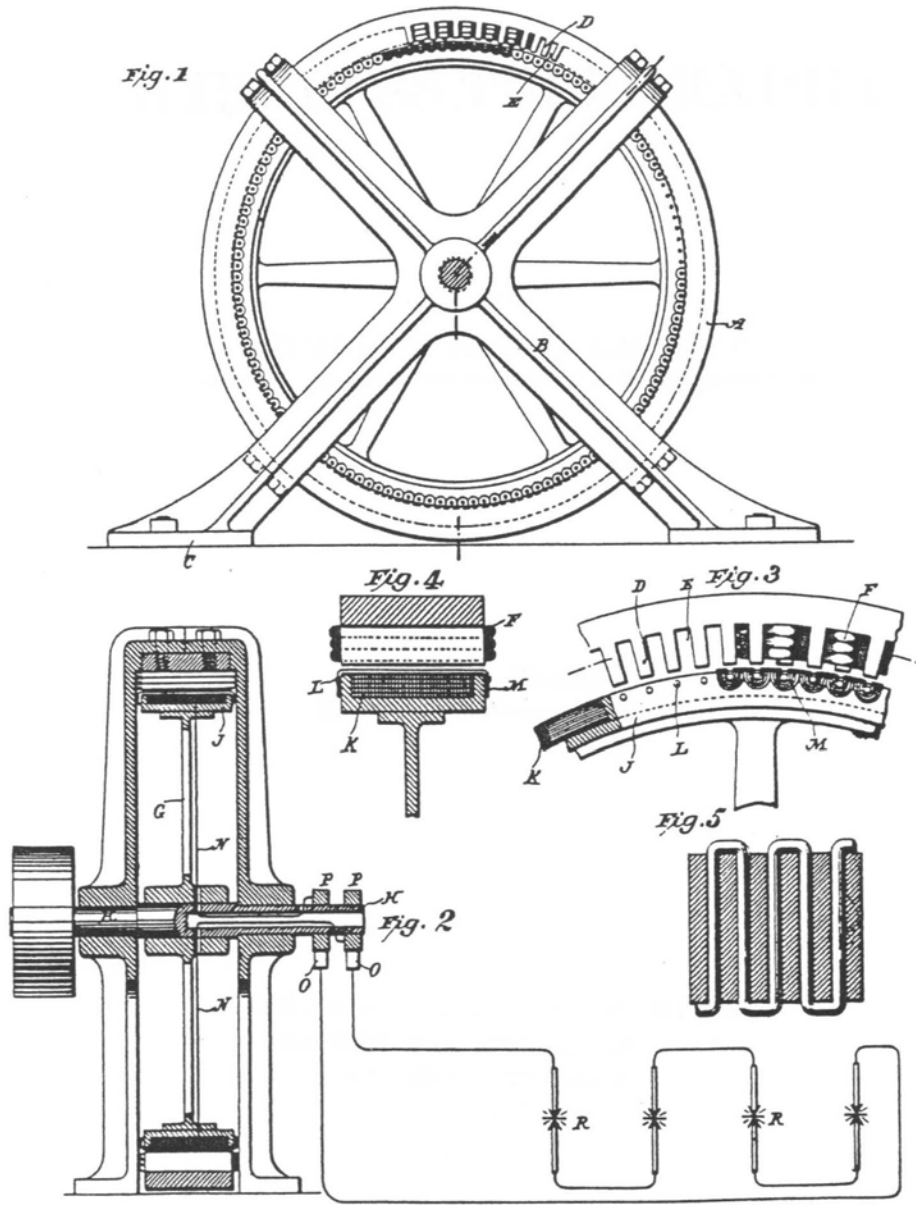

Witnesses:  
*Raphael Netto.*  
*M. G. Tracy*

Inventor  
*Nikola Tesla*  
by *Duncan & Page*  
Attorneys

Figure  
Diagrammatic illustration of first high frequency alternator with 384 poles, patent application filed October 1, 1890, also in book "Inventions, Researches and Writings of Nikola Tesla" by T.C. Martin, published by the Electrical Engineer, New York, 1893, Figs. 199-203, pp. 375-376.



ns of the lead  
ter with the  
the Leyden  
ransformer at  
potential  
cremely

# PRINCIPLES OF WIRELESS TELEGRAPHY

BY  
GEORGE W. PIERCE, A.M., PH.D.  
ASSISTANT PROFESSOR OF PHYSICS IN HARVARD UNIVERSITY

FIRST EDITION  
SECOND IMPRESSION, CORRECTED

McGRAW-HILL BOOK COMPANY  
239 WEST 39TH STREET, NEW YORK  
6 BOUVERIE STREET, LONDON, E.C.  
1910

TESLA METHOD

bank of jars is connected by means of the leads  $W, W'$  with the secondary of a Ruhmkorff coil, or better with the secondary of an alternating current step-up transformer, the Leyden jars are repeatedly charged by the Ruhmkorff coil or transformer at intervals of, say,  $\frac{1}{100}$  or  $\frac{1}{200}$  of a second. When the potential at each charge of the jars reaches a value high enough to spark across the gap  $G$ , the jars discharge with oscillations of extremely high frequency. A group of these oscillations occurs during each spark at the gap  $G$ . These

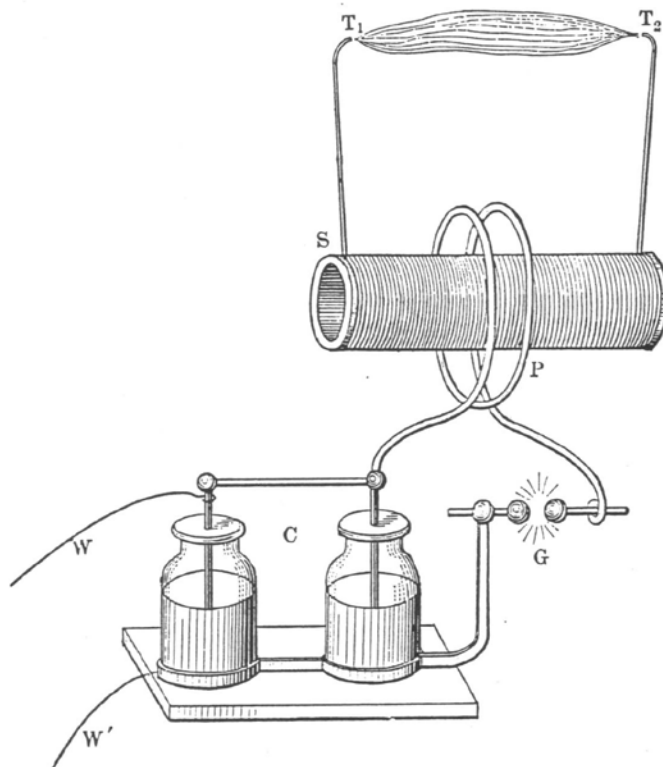

FIG. 63. Tesla or Thomson coil.

high-frequency oscillations in the primary coil  $P$  act inductively on the secondary coil  $S$ , and on account of the extreme rapidity of change of current in the primary, the electromotive force induced in the secondary is very high, and produces a series of sparks between the terminals  $T_1$  and  $T_2$  of the secondary.

It should be noted that the primary has a period of its own, and that the coil of wire  $S$  used as a secondary has also a period of its own; and in order to get the greatest spark at the secondary terminals, it is necessary to adjust the number of jars  $C$  or else the number of turns of wire on either  $P$  or  $S$ , so that the condenser

TESLA  
 TESLA WIRELESS  
 METHOD



circuit and the secondary coil shall be in resonance with each other.

By the use of apparatus of this character Mr. Tesla has produced enormous sparks — twenty-three feet long and of great volume — graphically described as being accompanied by a roar like Niagara.

The transformer  $PS$  is called a *high-frequency transformer*, an *oscillation transformer*, or an *air-core transformer*, to distinguish it from an ordinary iron-core transformer, such as is used with commercial alternating currents of slow frequency.

Oscillation transformers, built on somewhat different lines from the one above described, have met with application to both the sending and the receiving circuits of electric-wave telegraphy, and by the use of these transformers a considerable advance has been made, both in the greater distances attained and in the diminished confusion of signals of different wave lengths.

**Two Systems of Coupled Circuits.** — The form given to these coupled circuits is considerably varied in practice. There are, however, two important general types. These are represented in the accompanying figures (Fig. 64 and 65) and are called respectively the *inductively coupled* and the *direct coupled* types.

**The Inductively Coupled Type.** — This type is shown in Fig. 64. In this system the sending station, shown on the left, is seen to consist of a Tesla high-frequency apparatus, with one secondary terminal connected to an antenna and the other secondary terminal connected to the ground. Power is supplied to the circuit by an alternating current transformer or a Ruhmkorff coil to which the wires  $W$ ,  $W'$  lead.

The receiving station of this system, shown at the right in Fig. 64, has also an oscillation transformer  $P' S'$ , and is in principle like the sending station, except that the detector  $D'$  with its accessories is usually put in place of the spark gap of the sending apparatus. The coils  $P'$  and  $S'$  and condenser  $C'$  used with the receiving apparatus generally have different inductances and capacity from those of the sending apparatus, and not being traversed by high-potential currents they are usually made more compact.

In this inductively coupled system of circuits, oscillatory currents in the sending antenna are produced inductively by the oscillatory discharge of the condenser  $C$  through the primary coil  $P$ . These oscillatory currents in the sending antenna produce

electric waves, which travel away in all directions with the velocity of light (186,000 miles per second). Arriving at the receiving station these electric waves set up oscillations in the antenna circuit  $A'P'E'$ . These currents through  $P'$  act inductively on  $S'$ , and produce oscillatory currents in the detector circuit.

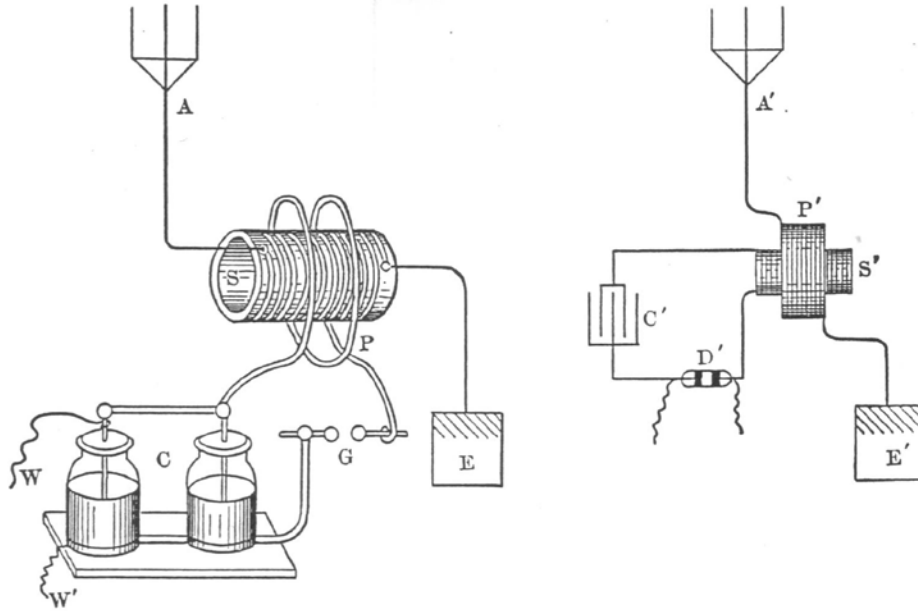

FIG. 64. Inductively coupled transmitting and receiving circuits.

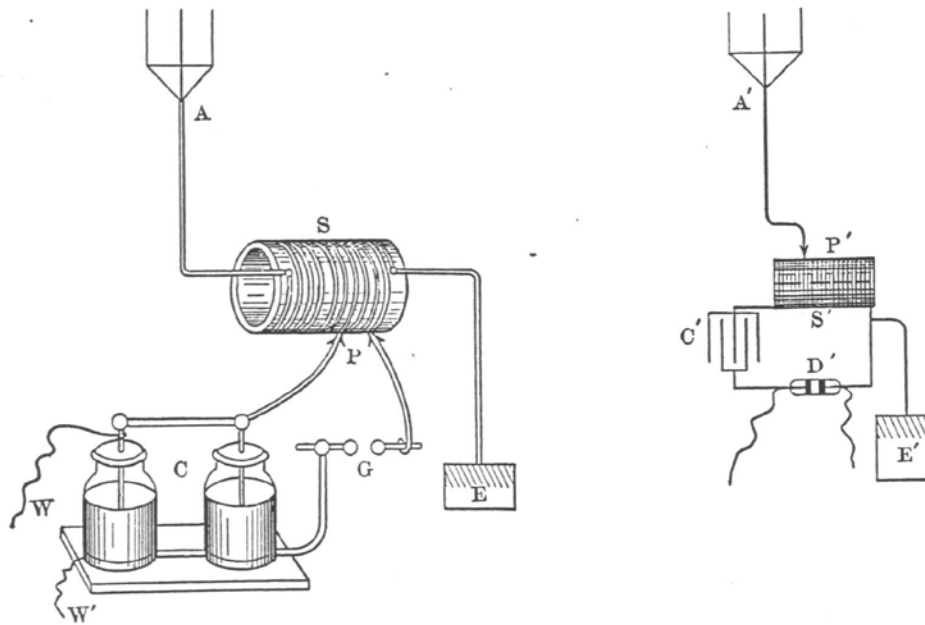

FIG. 65. Direct coupled transmitting and receiving circuits.

**The Direct Coupled Type.**—Figure 65 shows the other form of coupled apparatus, constituting the *direct coupled system*. This

TESLA METHOD



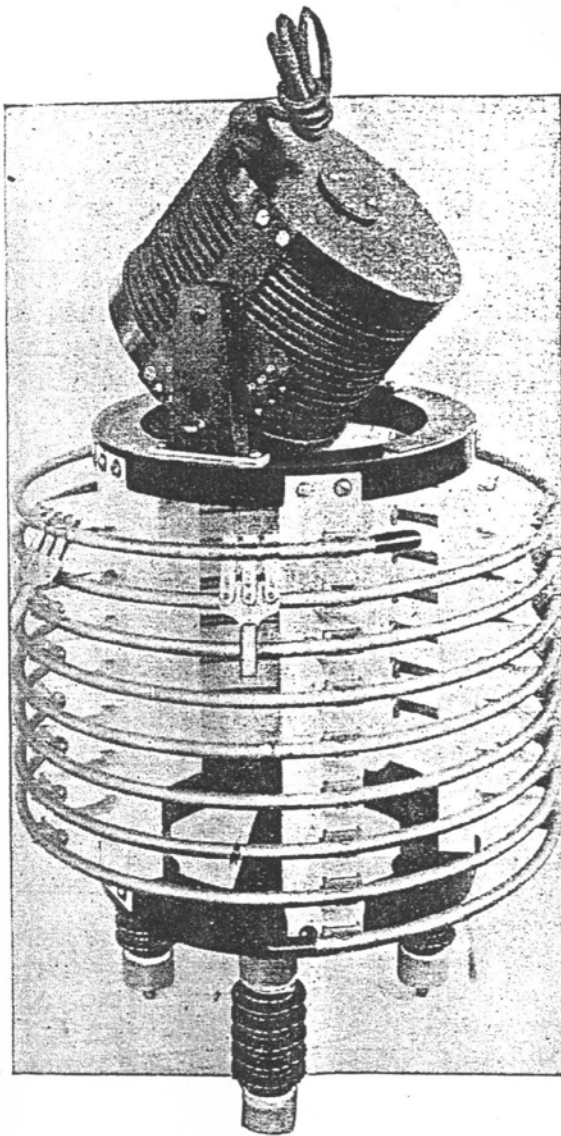

Fig. 119—Type A Oscillation Transformer of the American Marconi Company.

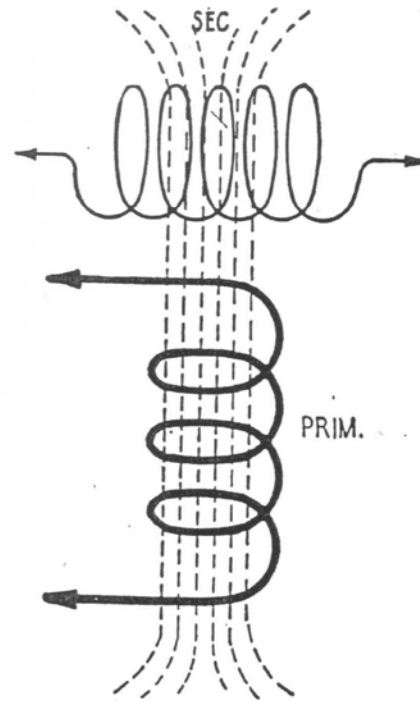
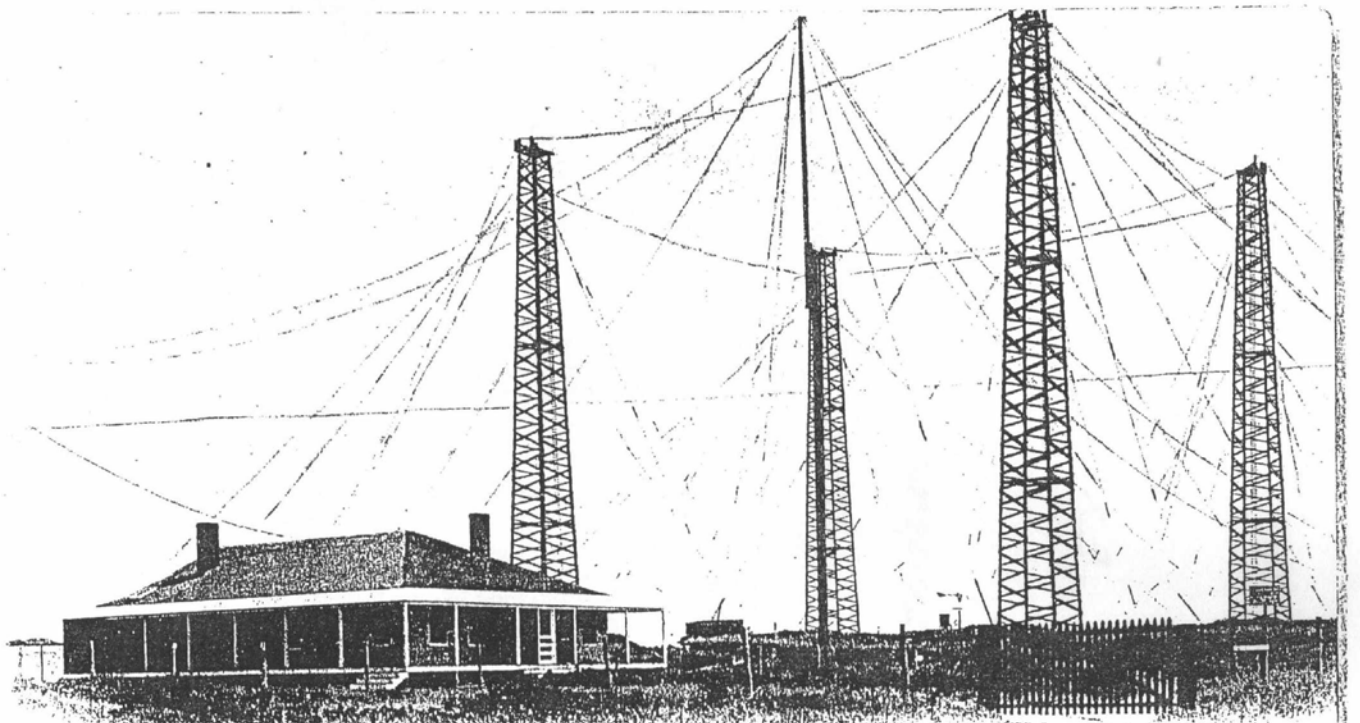

Fig. 120—Showing the Effect of Turning Secondary at Right Angles to Primary.

MARCONI  
ADAPTATION  
OF  
TESLA METHOD



A 7340 Marconi's Wireless Telegraph Experimental Station, South Wellfleet, Mass.





MARCONI AND  
HIS  
EXPERIMENTS

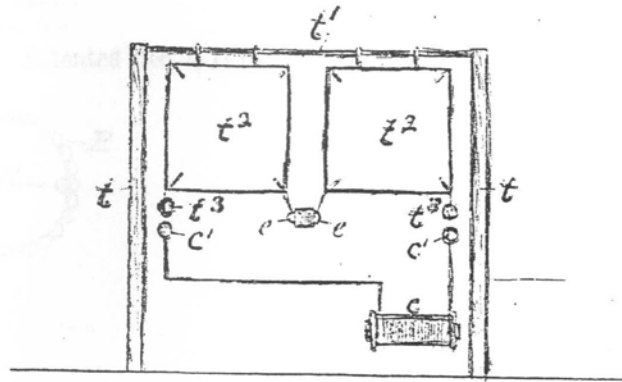
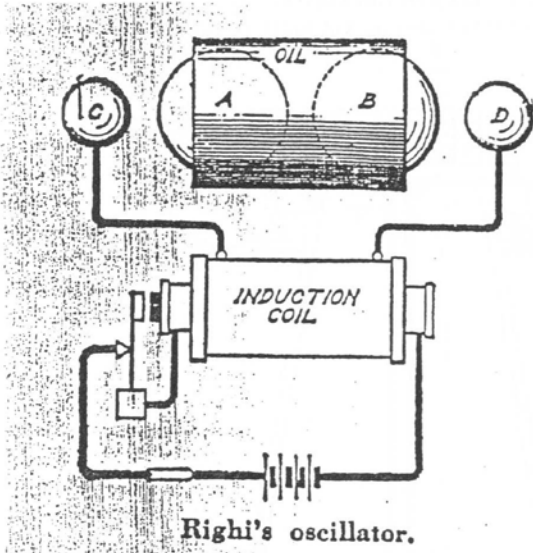

MARCONI'S  
RIGHI OSCILLATOR

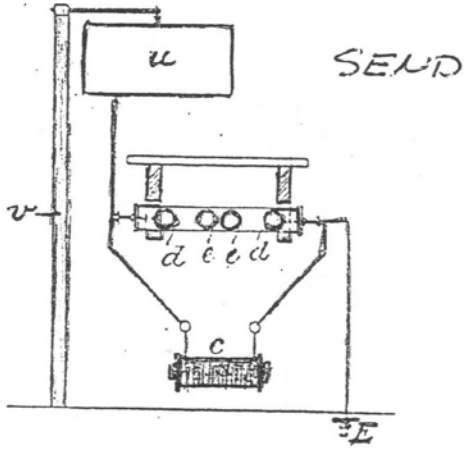

MARCONI'S  
FIRST  
"RIG" →

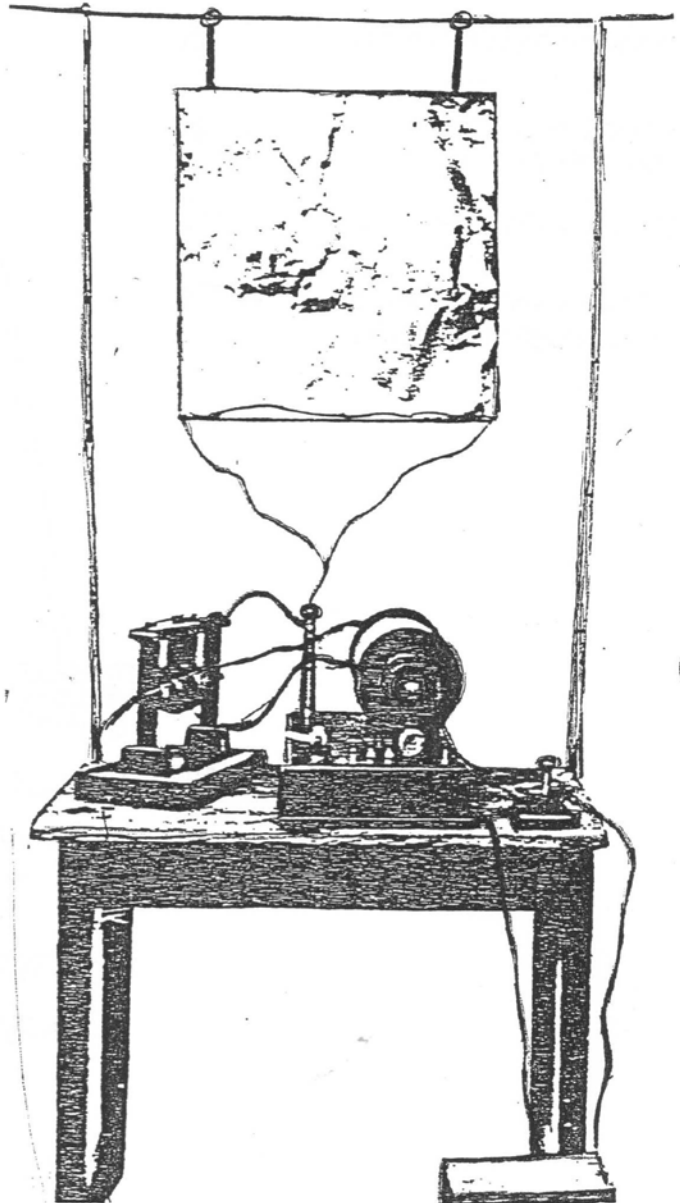
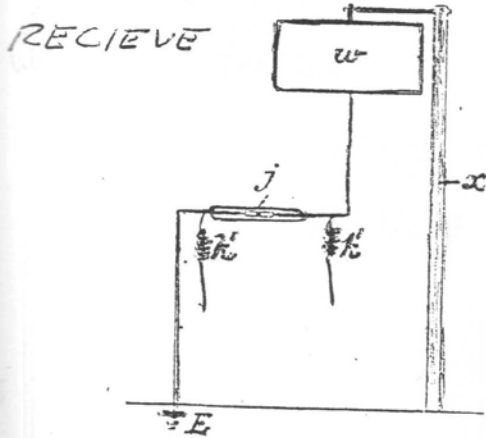



N. TESLA.  
 APPARATUS FOR TRANSMITTING ELECTRICAL ENERGY.  
 APPLICATION FILED JAN. 18, 1901. RENEWED MAY 4, 1907.

1,119,732.

Patented Dec. 1, 1914.

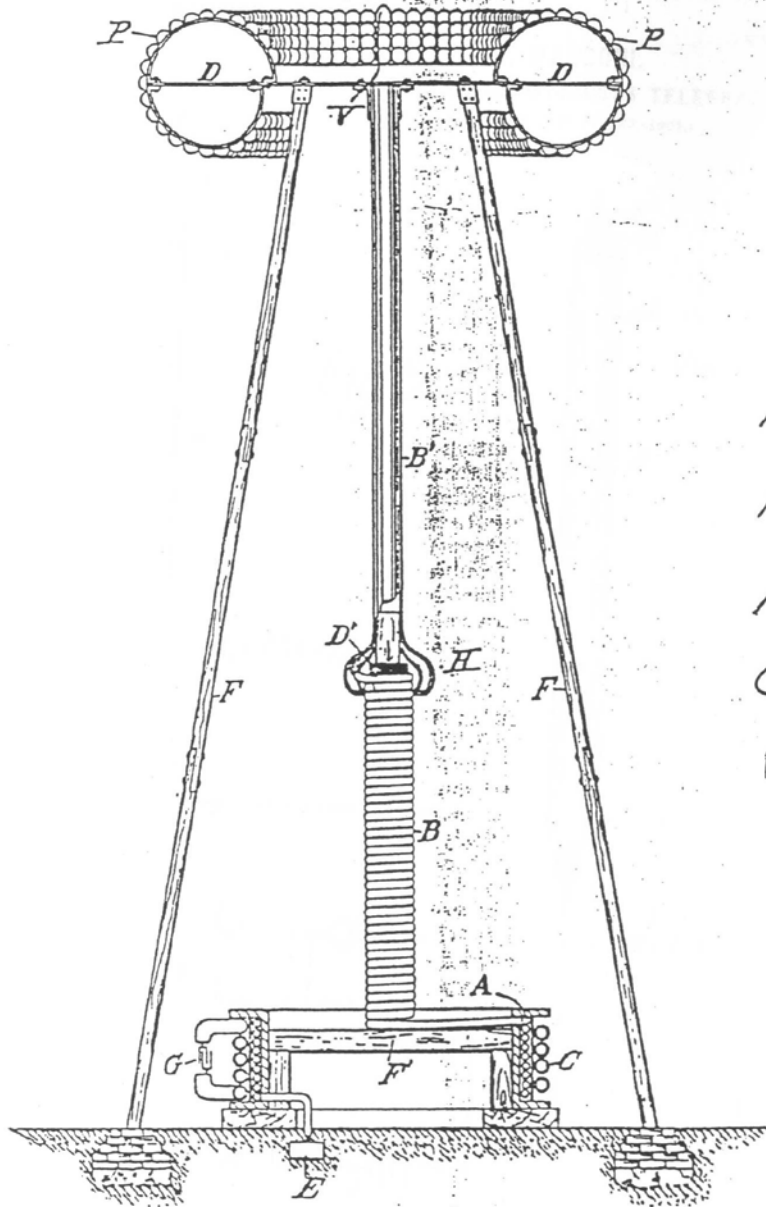

- P - P, ELEVATED CAPACITY
- B - MAGNIFICATION COIL
- A - C OSCILLATION TRANSFORMER
- G - CONDENSER
- E - EARTHING ELECTRODE

WITNESSES:

*M. Lawson Dyer*  
*Benjamin Miller*

*Nikola Tesla*, INVENTOR,  
 BY *Kerr, Page & Cooper*,  
 his ATTORNEYS.

FIG 9, LATER  
 TESLA DESIGN

G. MARCONI.

APPARATUS FOR WIRELESS TELEGRAPHY.

(Application filed Feb. 23, 1901.)

(No Model.)

2 Sheets—Sheet 2.

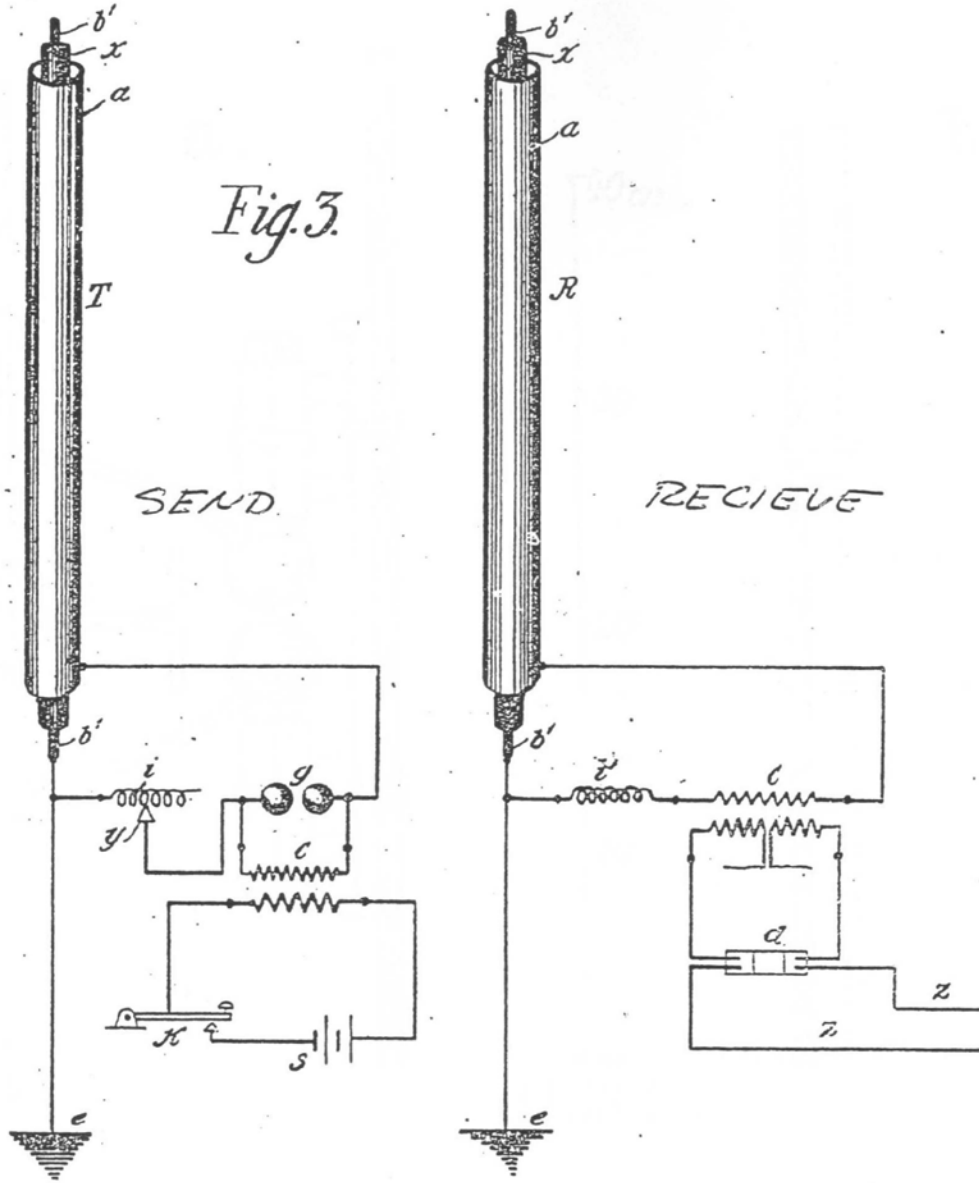

Fig. 3.

SEND.

RECIEVE

WITNESSES:

*Wm. Tallman,*

*Harry Prosser*

INVENTOR

Guglielmo Marconi,

BY

*Butts, Butts, Shapell & Co*

FIG 9, LATER MARCONI DESIGN



SEND

RECEIVE

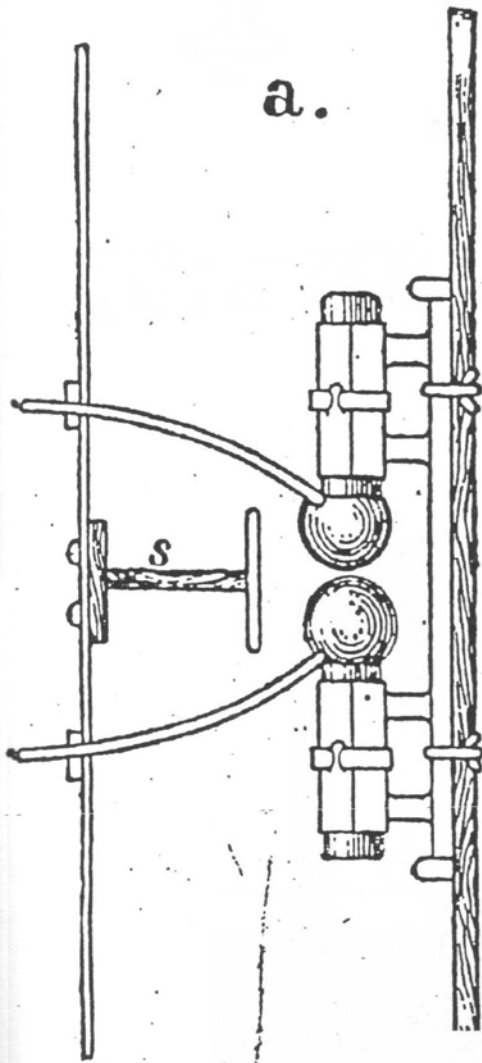

40 cm.

30

20

10

0

HERTZ

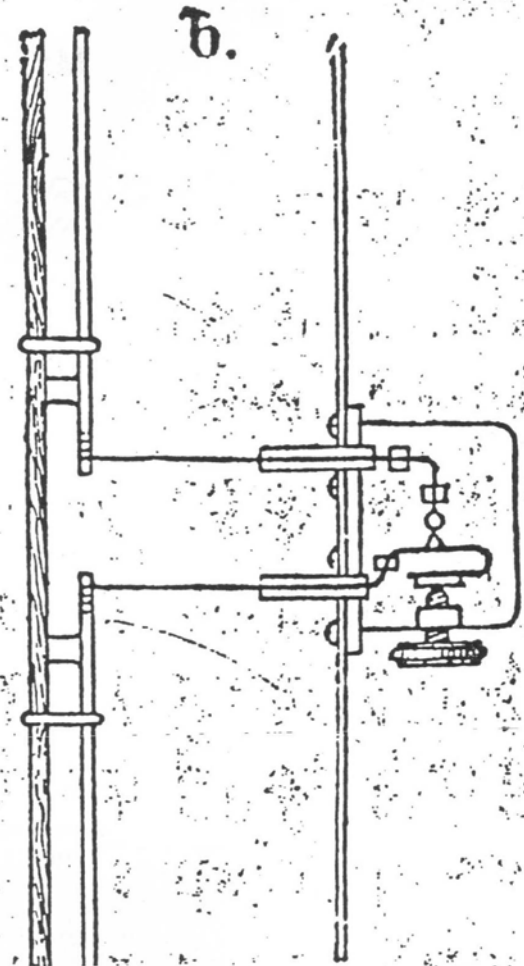

ORIGINAL HERTZIAN  
U.H.F. TRANSMISSION  
EXPERIMENTS UPON  
MAXWELL THEORIES

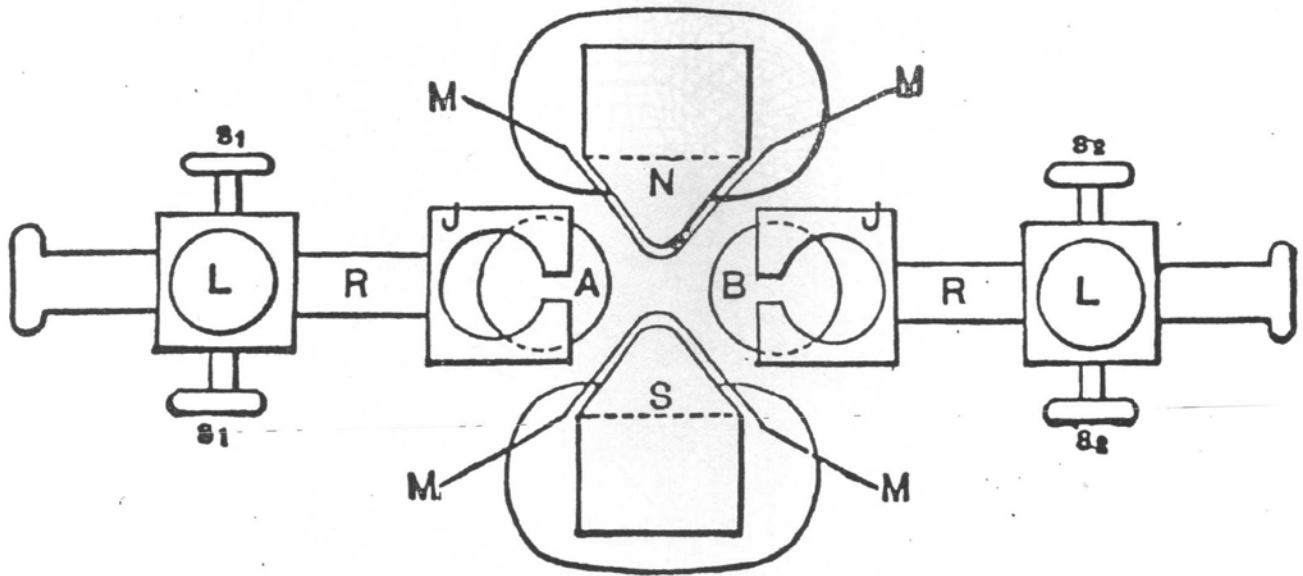

1892 - TESLA'S OSCILLATOR GAP  
LATER PATENTED BY POLSON.

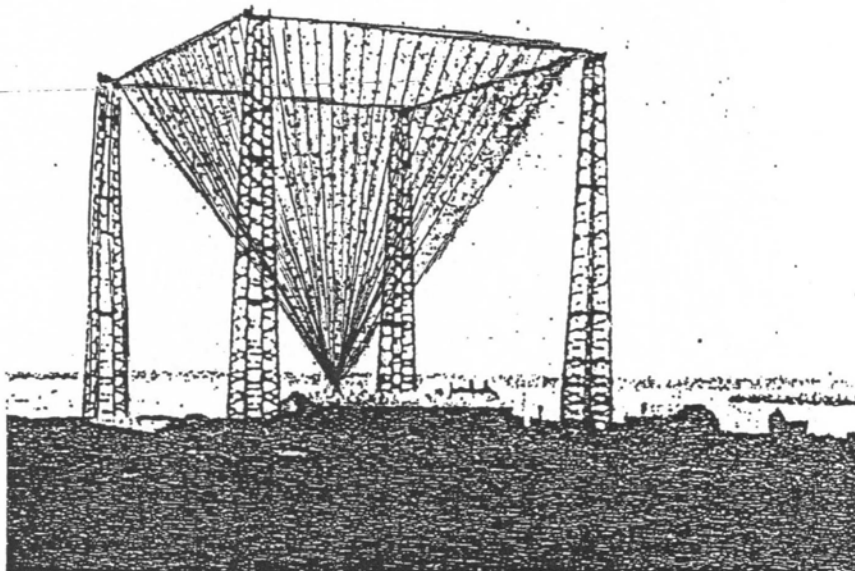

FIG  
10

GLACE BAY  
INVERTED PYRAMID  
RECEIVING AERIAL

1900

MARCONI'S VERSION OF  
TESLA PATENTS 1119732 &  
645,756.



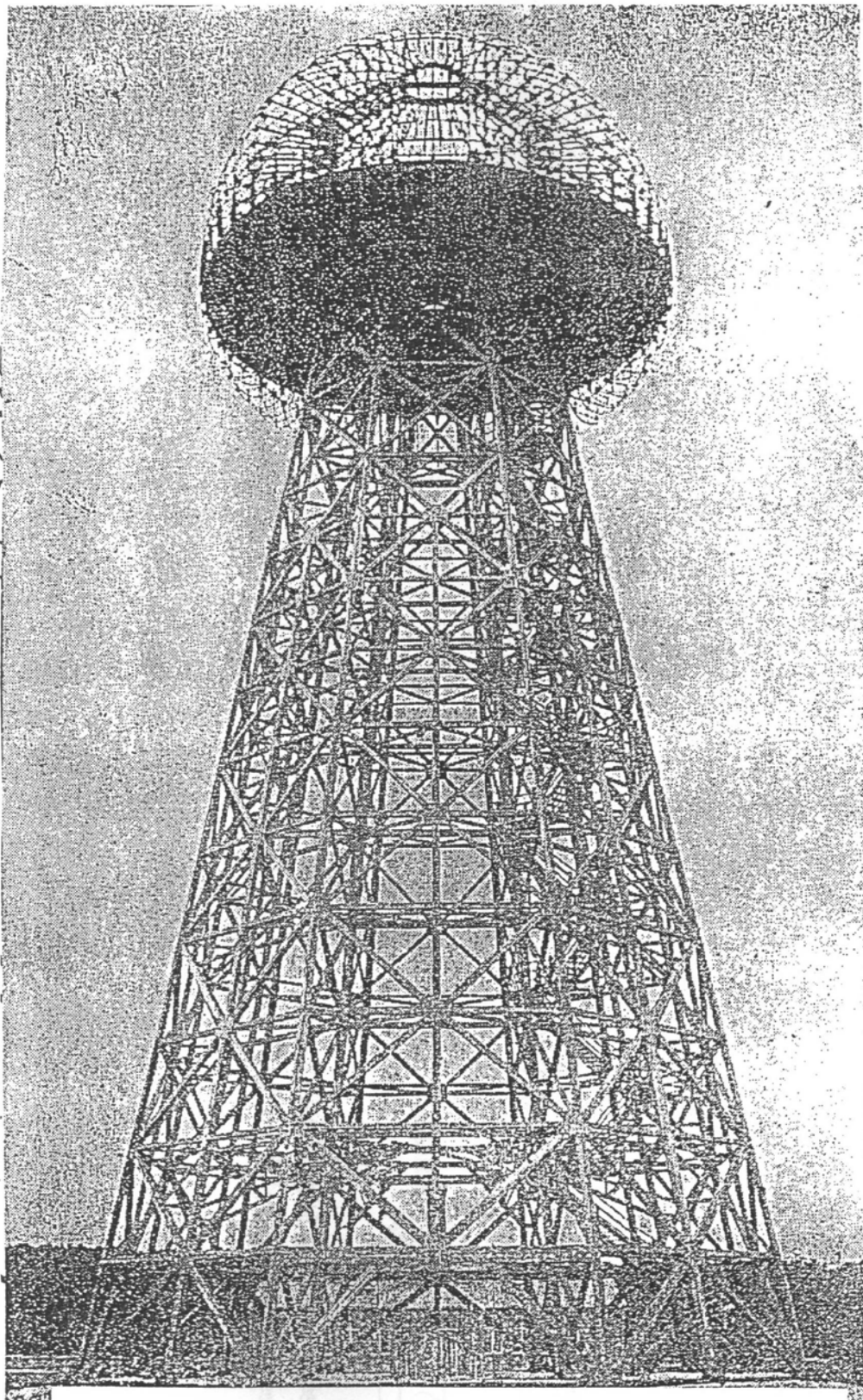

↑  
187  
FEET  
HIGH  
↓

WARDENCLYFFE  
CAPACITY TOWER

TESLA

FRAME

FIG 10A

1903



MARCONI  
CLIFDEN STATION  
BENT-L FAN AERIAL

FIG 10 B

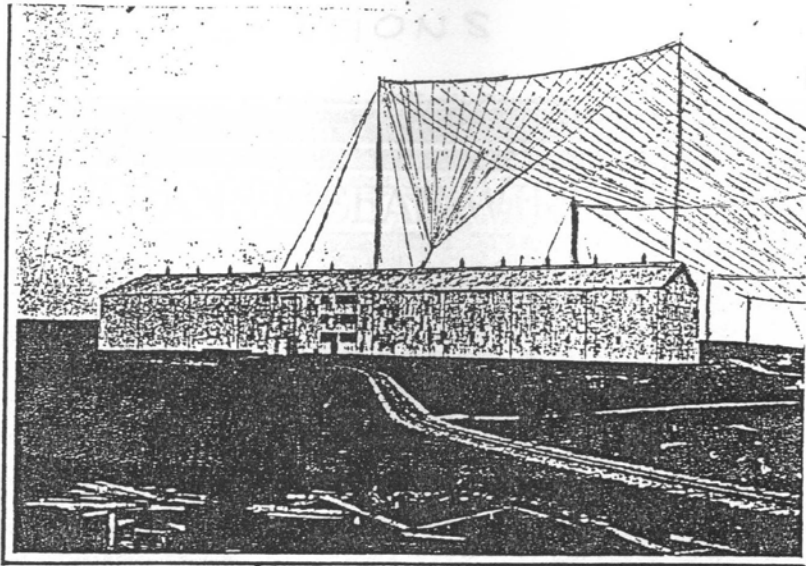

PRE-  
BOLINAS  
PROTO-  
TYPE

Condenser House and Antenna Grid.

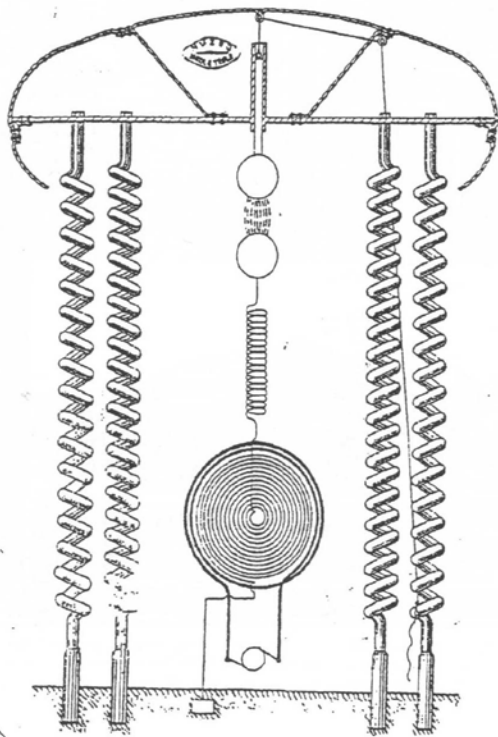

TESLA'S  
WARDENCLYFFE  
NOTES

HR



# MARCONI'S FINAL STATIONS

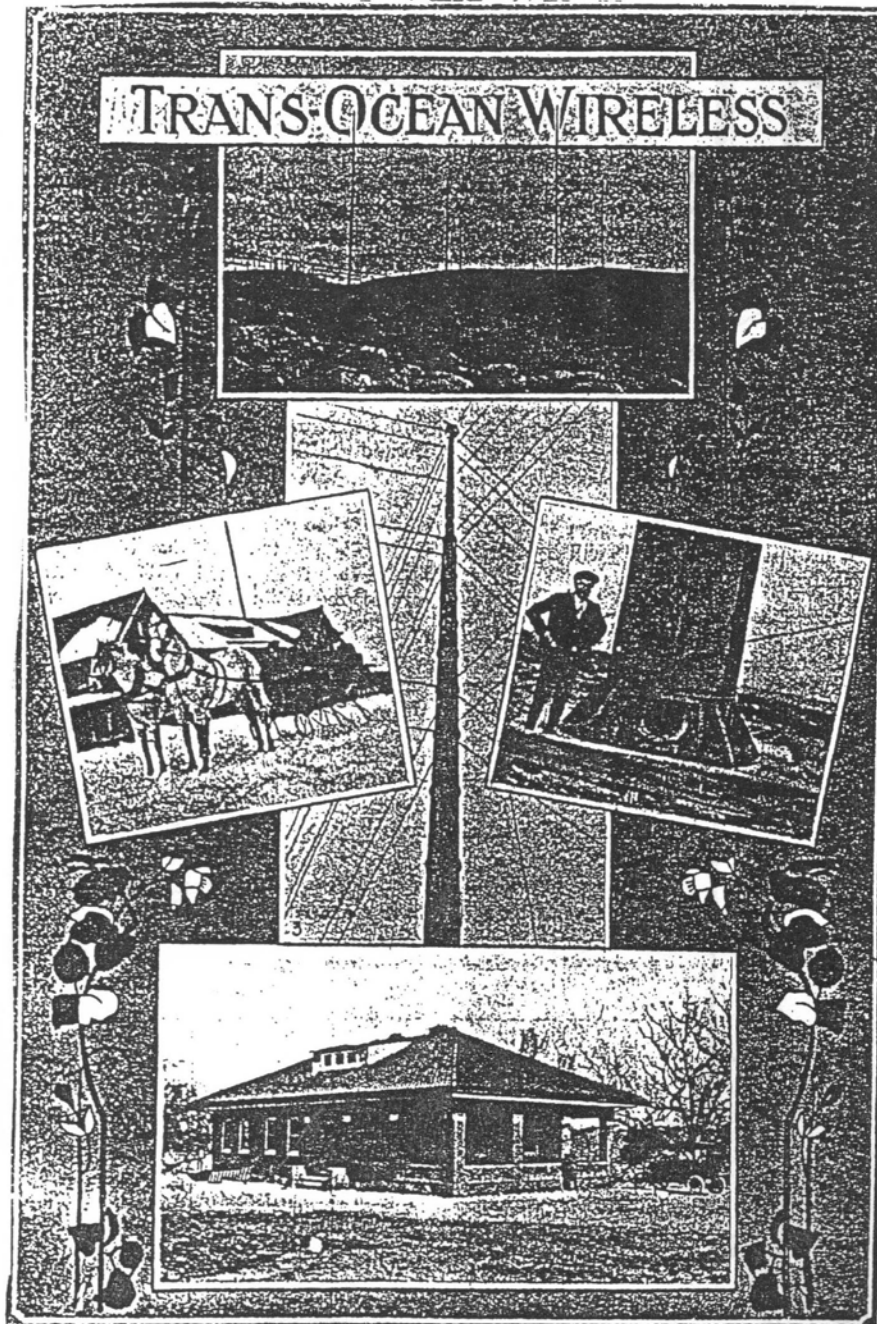

1.—Transmitting Station, Stavanger, Norway. 2.—Belmar, N.J. (U.S.A.) The only means of transportation. 3.—Top of 400 ft. mast at Carnarvon. 4.—Base of the same mast. 5.—Belmar, N.J., operators' quarters.

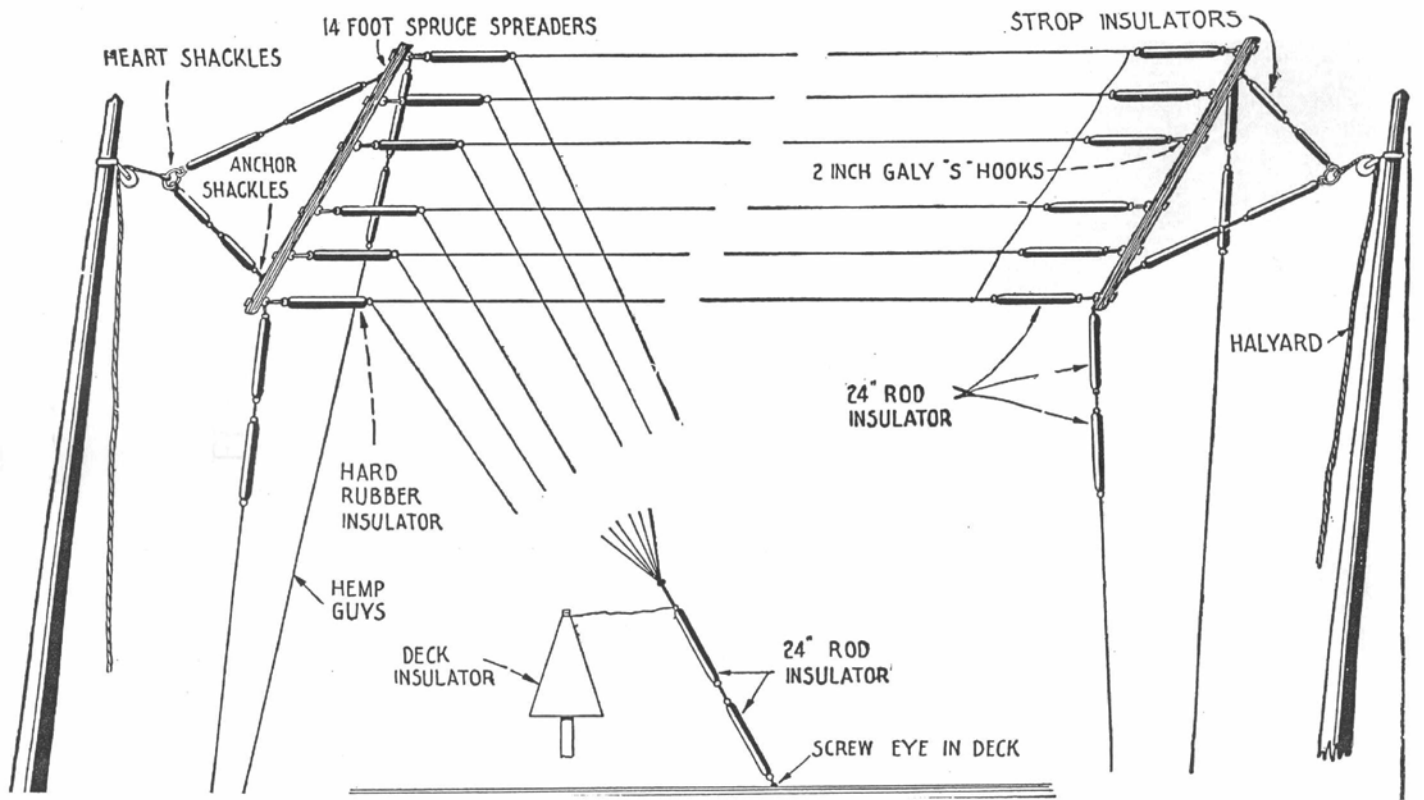

FINAL MARCONI  
AERIAL STRUCTURE  
"THE  
BENT L AERIAL"



FIG 13



FESSENDEN

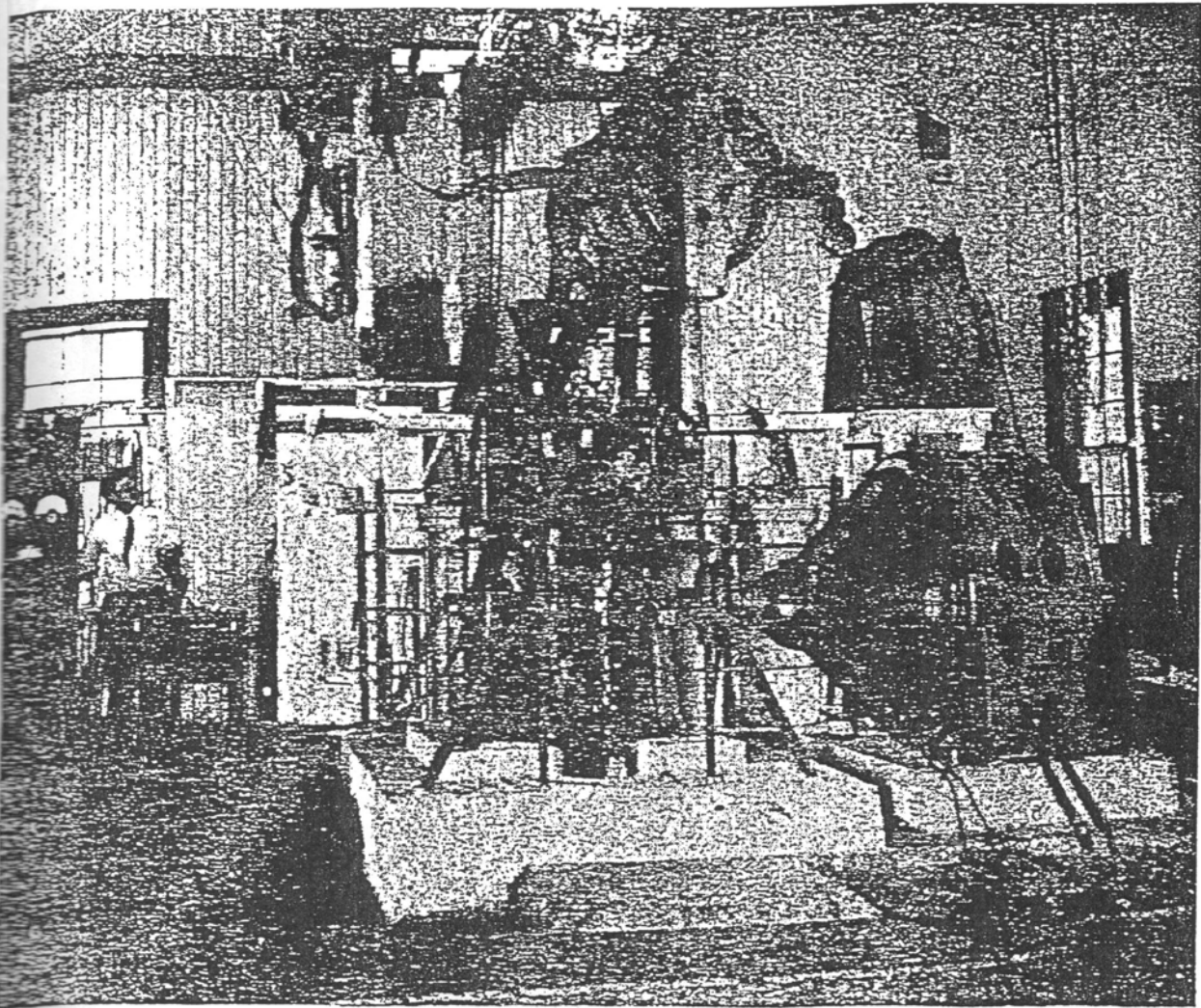

a photograph in the collection of Dr. R. A. Fessenden

MEASURING THE HEIGHT OF THE HEAVISIDE LAYER

47



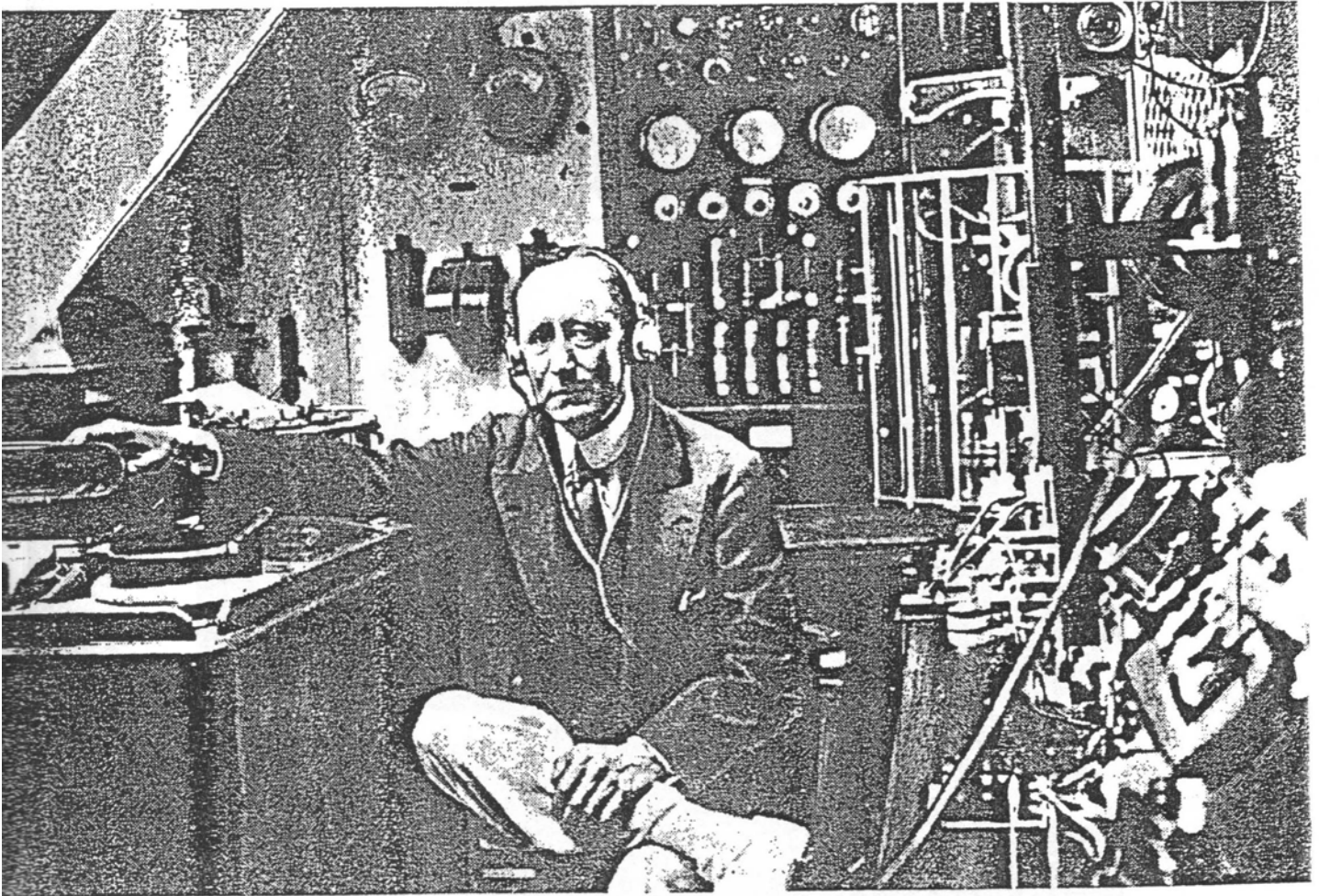

MARCONI  
SHIPBOARD SHORTWAVE



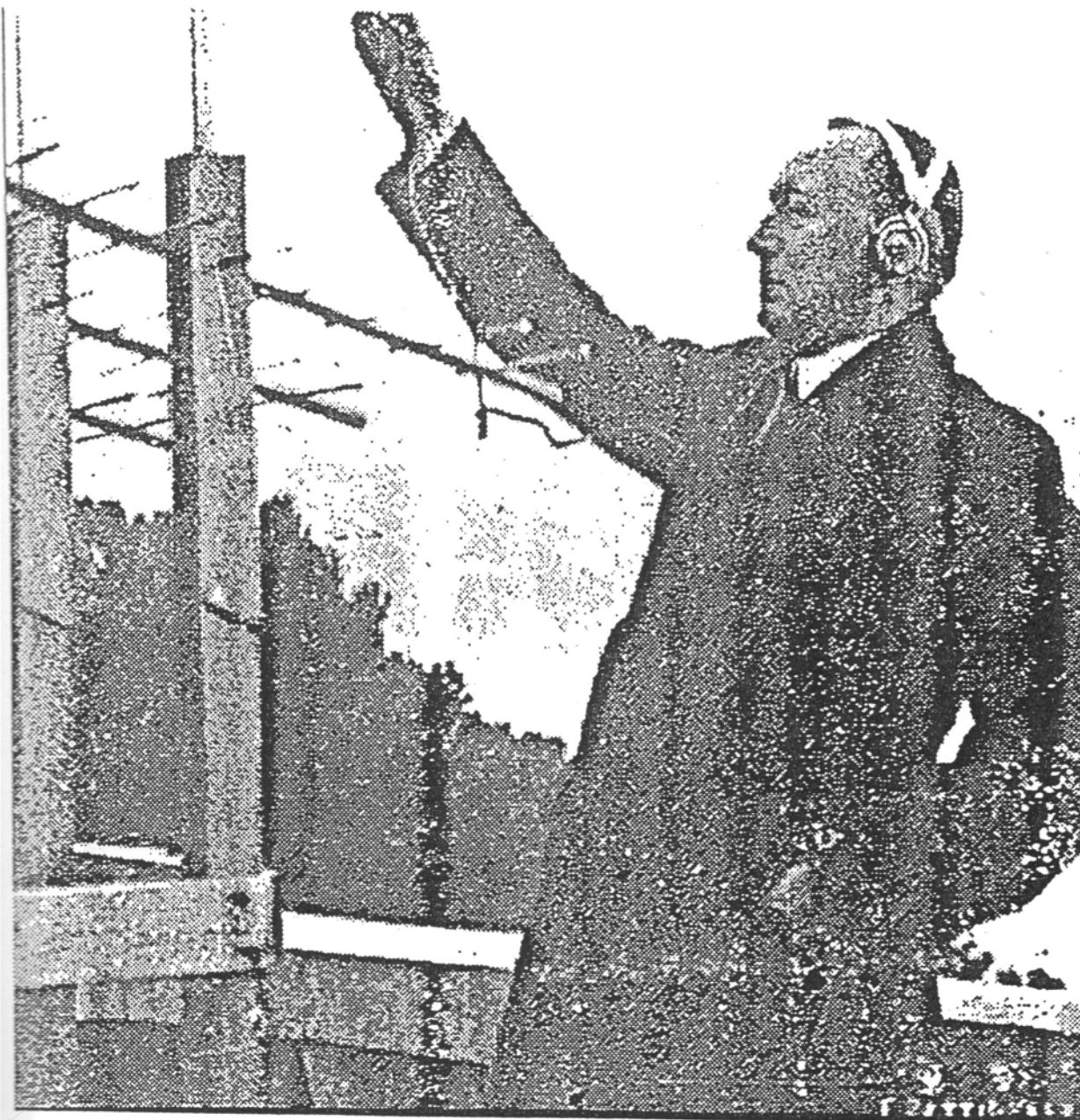
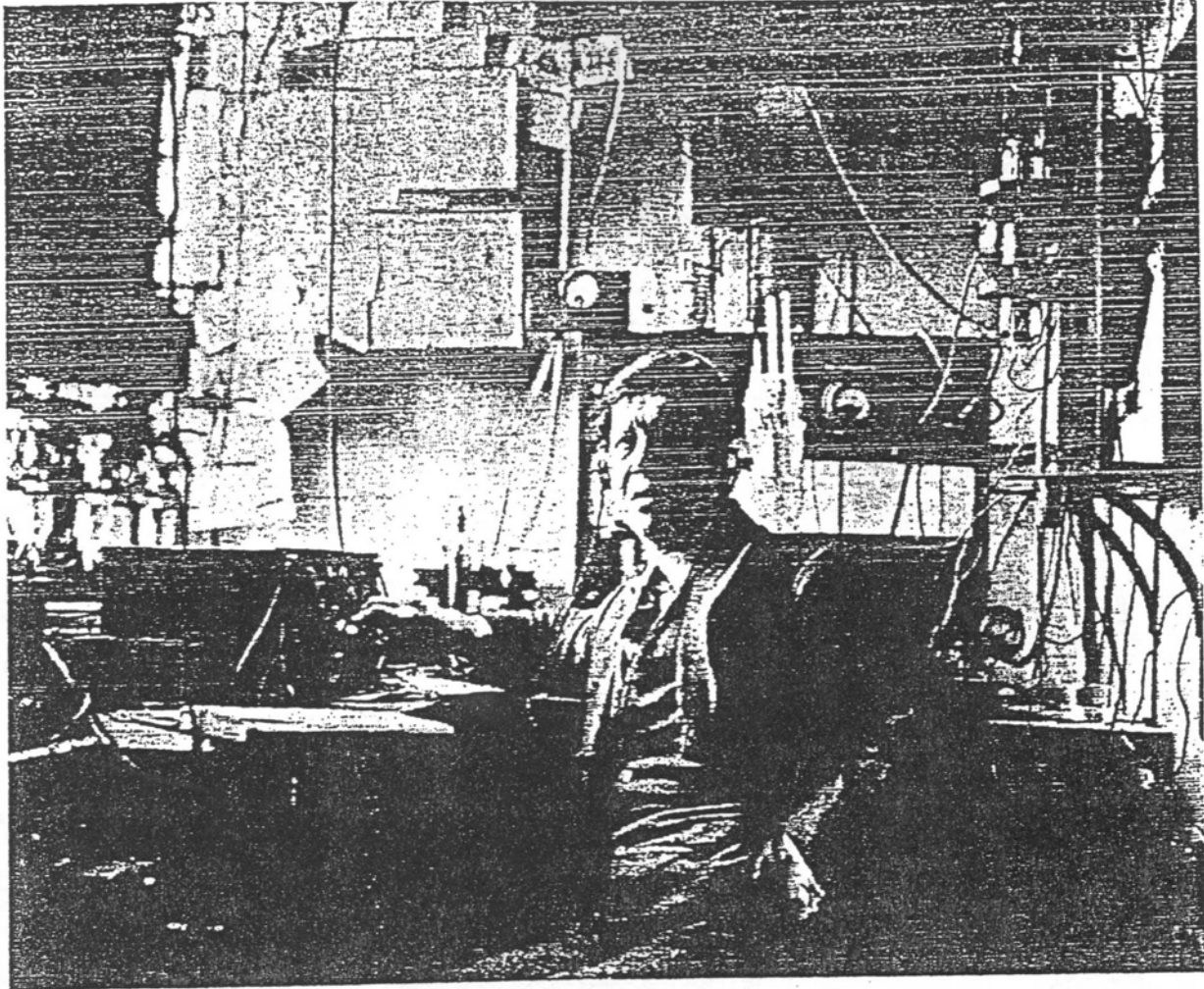

FIG 15, VERY SHORT WAVES





#### ENGLAND'S BEST-KNOWN "HAM"

*Thousands of American amateurs are familiar with the signals of Mr. Gerald Marcuse (2 NM). Here is the radio shack from which they come at Caterham, Surrey, England. Mr. Marcuse's receiving apparatus is shown at the left of the picture, while just to the right of his head may be seen the huge quartz tube used in many recent transmissions.*

FIG 16



# JUST A FEW OF 1500

## The Electro "Government" Phones

Highest Precision Phones Made in the United States  
BANDS HARD RUBBER COVERED Adopted by several Governments



No. 1950

Designed and made for WIRELESS

This headgear is the lightest on the market to-day. Each receiver is wound to 1500 ohms, giving 3000 ohms per set. The German silver HEAD BANDS ARE COVERED WITH HARD RUBBER, thereby affording the best possible insulation. NON-RUSTING DIAPHRAGMS.

Other points of superiority. Light rubber cap, highest insulation, not only inside of the windings, to insure against breakdown, but the headgear is entirely insulated from the phones themselves. The switch arrangement is of the latest approved style, so that the phones will fit the ear snugly to exclude all external noise. We use a six-foot pure silk covered cord with two tips.

The magnets are wound with No. 14B & S ENAMEL COPPER WIRE. The magnets are a great deal more powerful, being made of the best imported Swedish tungsten steel.

We lay particular stress on the magnets of this receiver and we guarantee that the magnets will not lose their strength for two years.

Price, \$8.00

## The Pride of Every Amateur

### The "Electro" Rotary Variable Condensers

Consider these features: FIRST THESE CONDENSERS ARE THE ONLY ONES MADE WITH A TRANSPARENT CASE IN WHICH OIL CAN BE USED WITHOUT IT LEAKING. In this way the condenser capacity can be increased FIVE TIMES. SECOND—THIS CONDENSER IS THE ONLY ONE NOW ON THE MARKET WITH CONNECTIONS AT THE BOTTOM. Cover is of highly polished hard rubber composition with a large scale that is easily read.

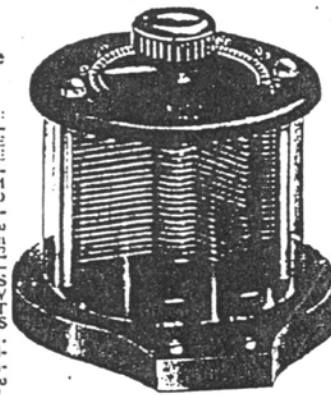

No. 9240 "Electro" Rotary Variable Condenser, 17 Plates, size 4 1/2 x 3 1/2, in. Shipping weight 2 lbs. \$2.75  
No. 9241 "Electro" Rotary Variable Condenser, 43 Plates, size 4 1/2 x 3 1/2, in. Shipping weight 3 lbs. \$4.25

### The "Electro" Vario Selective Coupler

CABINET TYPE

This outfit can tune to wavelengths from 100 meters to 3,000 meters.

The entire outfit is made of highly polished metal, with switches controlled by hard rubber handles, and the binding posts and metal parts of brass, nickel plated.

Smallest and most compact long distance wireless receiving outfit manufactured.

No. 11000 "Electro" Vario Selective Coupler for phones or detectors \$6.50

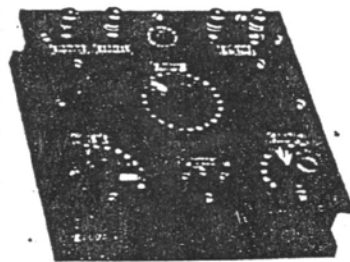

No. 11000 Shipping weight 5 lbs.

## Guaranteed "Electro" Storage Batteries

As Made by Us for 12 Years

The battery which was first designed by us as an improvement on the battery which meets with the greatest success in use, and of course, the real one. It is a battery of the highest quality. There is nothing to get out of it except what you put in it. This battery will last for years.

It is a battery of the highest quality. There is nothing to get out of it except what you put in it. This battery will last for years. It is a battery of the highest quality. There is nothing to get out of it except what you put in it. This battery will last for years.

It is a battery of the highest quality. There is nothing to get out of it except what you put in it. This battery will last for years.

No. 2125 "Electro" Storage Battery, 4 volts, 40 ampere hours, size 7 1/2 x 4 1/2 x 4 1/2, \$4.20

No. 856 "Electro" Storage Battery, 6 volts, 40 ampere hours, size 8 1/2 x 5 1/2 x 4 1/2, \$6.25

No. 2127 "Electro" Storage Battery, 4 volts, 60 ampere hours, size 7 1/2 x 5 1/2 x 4 1/2, \$5.50

No. 858 "Electro" Storage Battery, 6 volts, 60 ampere hours, size 8 1/2 x 5 1/2 x 4 1/2, \$8.00

No. 2128 "Electro" Storage Battery, 6 volts, 80 ampere hours, size 9 1/2 x 5 1/2 x 4 1/2, \$12.00

No. 2129 "Electro" Storage Battery, 6 volts, 100 ampere hours, size 12 1/2 x 5 1/2 x 4 1/2, \$15.00

THESE BATTERIES ARE SENT FULLY CHARGED

BRAND 11-1081 No. 1  
67 West Broadway  
New York City Retail only

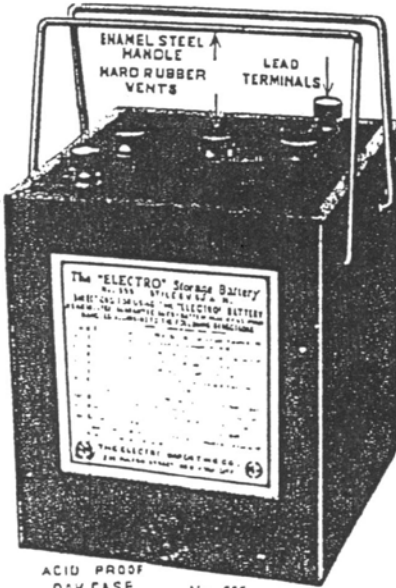

ACID PROOF OAK CASE No. 555

## NEW! NEW!! RADIOLITE

The most wonderful of all crystals. More sensitive than Galena, more sensitive than ANY other crystal or mineral.

The mineral that looks like liquid gold. Now in use by several governments. Equally sensitive all over. Used with a medium stiff phosphor lattice spring. Does not jar out easily. Sold by the piece only. Each crystal is tested and guaranteed. Each packed separately in a box. Money refunded if our claims are not substantiated.

Generous piece of tested Radiolite: \$0.60 Prepaid.

We are the sole American Retail Agents for Radiolite. IMMEDIATE SHIPMENTS. NO DELAY.



"The Livest Catalog in America"

YOU MUST HAVE IT

ELECTRO IMPORTING COMPANY

I enclose herewith 4 cents in stamps or coin for which please send me your latest Cyclopona Catalog No. 716 containing 270 pages, 68 illustrations and diagrams, including list of Wireless Telegraphy, complete list of U.S. Wireless Call Letters, and 20 coupons for your 100 page 1936 Wireless Course—11, 20 lessons.

Write your name and address in the margin below

THE ELECTRO IMPORTING CO.

BRANCH STORE No. 2, 217 Livingston Street, Brooklyn, N.Y. Retail only

236 FULTON ST., NEW YORK

RADIO HAM ADVERTISING

# Practical Wireless Telegraphy

A COMPLETE TEXT BOOK  
*for* STUDENTS *of*  
RADIO COMMUNICATION

BY

ELMER E. BUCHER

Instructing Engineer

Marconi Wireless Telegraph Co. of America

Member Institute of Radio Engineers

---

Fully Illustrated

---

Revised Edition

---

5000 copies printed July, 1917  
5000 copies printed October, 1917  
5000 copies printed February, 1918  
5000 copies printed March, 1918  
5000 copies printed May, 1918  
5000 copies printed June, 1918  
10000 copies printed August, 1918  
10000 copies printed October, 1918  
5000 copies printed December, 1919  
7500 copies printed May, 1920





# JOIN THE National Amateur Wireless Association

Founded to promote the best interests of radio communication among wireless amateurs in America

Guglielmo Marconi  
President

J. Andrew White  
Acting President

H. L. Welker  
Secretary

Help the cause of the Amateur by becoming a member of an organization that protects the Amateur at all times

**"IN UNION THERE IS STRENGTH"**

**INITIATION FEE**

An initiation fee of \$1.50 is required of all new members to pay for initial membership equipment, consisting of Nos. 1, 2, 3, 4 and 5.

**ANNUAL DUES**

The annual dues are two dollars (\$2.00). For this members receive:  
1. The monthly bulletin service.  
2. THE WIRELESS AGE for 1 year.  
3. Ten per cent discount on any wireless book published and other features to be announced later.

**EQUIPMENT**

1. Certificate of Membership (steel engraved) bearing Senator Marconi's endorsement as President and signed by the officers.
2. 36-inch felt Aerial pennant, four colors, on scarlet felt.
3. Membership pin; gold and enamel. (See design above.)
4. How to Conduct a Radio Club, by E. E. Bucher. Price 75c.
5. How to Pass Government Wireless License Examination. Price 75c.
6. One year's subscription to THE WIRELESS AGE.
7. Monthly Bulletin Service.

**APPLICATION BLANK**

Harry L. Welker, Secretary,  
National Amateur Wireless Association,  
326 Broadway, New York City.

As I desire to receive full recognition as an amateur wireless worker of the United States, I ask the privilege of enrollment as a Member in the National Amateur Wireless Association and request that you send me the complete Member's Equipment, for which I enclose herewith remittance of \$1.50 Initiation Fee, covering Initial Equipment, and \$2.00 for First Annual Dues, or \$3.50 in all.

I trust you will act upon my application promptly and forward the equipment to me at the earliest possible date.

My qualifications for Membership are given in blank spaces below.

Signature..... Street Address.....  
Town.....State..... Age.....

**FILL IN ANSWERS TO THESE QUESTIONS**

1. Have you a Government License (give number.....) or do you propose applying for one?.....
2. If you are under 21 years of age, give names of 2 adults for references as to character:  
Reference .....Address.....  
Reference .....
3. If you are a member of any Local, State or Interstate wireless club or association, give its name and name of Secretary with address.....  
.....
4. Are you now a subscriber to THE WIRELESS AGE?.....
5. Describe briefly your equipment.....  
.....  
.....

## **Chapter Three**

### **The Radio Corporation of America**

Author Commentary: pages 91 - 103

Historic Documents: pages 104 - 130



### III) The Radio Corporation of America

1) The American corporation General Electric was born in 1892 through the union of the two principle electrical manufacturers of the era, the Thompson-Houston Electric Company, and the Edison General Electric Company. Thompson-Houston worked in the new alternating currents (A.C.) of Nikola Tesla, and Edison worked with the well-established direct current (D.C.) systems of his design. Edison was a strong opponent to any A.C. development, perceiving it as a threat to his own D.C. operations. Edison staged events where stray pets were "Westinghoused," that is, killed by A.C. electric shock. He even developed the A.C. electric chair for his promotional effort. This created a wave of public fear of the development of A.C. systems. Ironically, Edison had received similar treatment from the illuminating gas companies when he had introduced his electric light and supporting D.C. systems. The formation of General Electric would serve to nullify these conflicts and unify the electrical industry. With his strong theoretical background and understanding of the mysterious A.C., Elihu Thompson helped to create the General Electric Research Laboratory in 1900. This was to become home of Charles Proteus Steinmetz, the foremost electrical genius of the 20<sup>th</sup> century. Steinmetz, along with his protegé E.F.W. Alexanderson, would find ways to circumvent the patents of Tesla-Westinghouse and De-Forest-A.T.T. Steinmetz devised his monocyclic A.C. system, bypassing Tesla and helping G.E. enter the A.C. markets of Westinghouse. Alexanderson would do the same with the wireless, avoiding De-Forest and Tesla priority. G.E. would prosper greatly in these areas and make a strong mark of the history of the wireless (fig. 17).



"To Tesla." An autographed picture of Edison, Tesla's first American employer. (Tesla Museum)

DC



George Westinghouse founded the Westinghouse Electric and Manufacturing Co. in 1886 and purchased Tesla's alternating current patents. (Westinghouse Electric Corp.)

AC

2) As with the electric power industry, the wireless grew out of vicious patent suits and fierce rivalries. The key elements of radio such as the thermionic electron tube of Lee De-Forest (1906) or the tuned circuits of Nikola Tesla (1900) were under full patent protection. Therefore use of these devices was blocked for competing companies. Numerous patents appeared on the scene, each claiming novelty, but in reality they were no more than adaptations of the original work. Conflicting theories created a wide split between pre-1900 and post-1900 inventors. Electrical science was giving way to atomic science at this time. Constant litigation and frequent bankruptcy, as well as tampering by Morgan/Rockerfeller interests greatly hampered the development of electric wave telegraphy and telephony. The condition forced government intervention.

The conditions that spawned the Radio Corporation of America are indeed a study of their own. The principle factors are the world war and the Alexanderson system of radio communication. The outbreak of war prompted the U.S. Government, in accord with the Radio Act of 1912, to take over all wireless facilities, and experimenters were prohibited from operating. Their station was dismantled, and American Marconi would relinquish its facilities to the U.S. Navy.

3) The basic conflict finds its origins in Marconi and his ambition to acquire the Alexanderson system of General Electric, and then monopolize this system. G.E. did not like this idea. Also, American Marconi was not so American. It was a British concern, and Marconi was an Irish-Italian, not a U.S. citizen. The conflict arose with a bill introduced by Rep. Joshua Alexander of Missouri, proposing a takeover of American Marconi. For Marconi's defense was former New Jersey Governor, and Taft's Attorney General, John Griggs. Griggs was president of American Marconi. Griggs would state: "Just when the farmer had planted his seed, plowed his field, harrowed it, and cultivated his crop, the corn ready to husk - the government comes in and says, 'We want that crop.'" Congressman William Greene protested the Alexander Bill and the U.S. Government takeover of wireless. The radio hearings were held, and on November 30, 1918 the American Marconi stations were sold. The hearings ended on Dec. 19, 1918.

Franklin D. Roosevelt, Assistant Secretary to the U.S. Navy, was to enter the picture in order to boost his aims toward becoming a U.S. president. Roosevelt would urge President Woodrow Wilson to suspend all G.E. sales to British Marconi. G. Marconi would offer the three million dollars for twenty-five of the Alexanderson alternators. Owen Young, counsel for G.E. and Admiral Bullard, Director of Naval Communication, negotiated with Marconi at the G.E. headquarters. G.E. Chairman Charles Coffin states at the meeting, "We will not put this machine in the hands of foreigners without some regulation and control." President Wilson proposed that the wireless (now radio) become a government sanctioned monopoly, such as the post office (the post office would control radio



in the United Kingdom). In July of 1919 Congress passed a resolution to give all government seized systems back to their rightful owners, the date of return to be March 1, 1920. At that time American Marconi's second vice-president, Nally, proposed that American Marconi join in a consortium with G.E. in order to sever its British ties. The complication faced in this whole affair was that only American Marconi held enough patents to make a working system of radio. G.E. did not; nor did A.T.T. Also at this time the fear of monopoly charges existed with regard to Wilson's proposal.

On Sept. 22, 1919, a radio consortium begins, as announced by the New York Times. J.P. Morgan was given the power to decide who would partake, and who would not partake. Principle Marconi employees were to stay with the consortium, such as Roy Weigant, Elmer E. Bucher and most importantly, Edwin Armstrong. Armstrong, with his work on the electron tube, were regarded as of equal importance to the central issue, the Alexanderson system. U.S.N. Admiral Bullard was made the official observer. On October 17, 1919 the consortium gave birth to the Radio Corporation of America. R.C.A. would keep the old office of American Marconi in the Woolworth Building for 15 years. On Feb. 20, 1920 the U.S. Navy would give its holdings to the newborn R.C.A.

A general period of uncertainty followed the inception of R.C.A. It is to be noted that upon the Marconi building in Bolinas a plaque was placed. It stated that the building, constructed by the J.C. White Co., was completed by 1920 for R.C.A. This was a falsehood. In a recent attempt to locate construction details of the Bolinas site with regard to the Alexanderson system, it was learned that this material had been destroyed so as to cover for certain acts on the part of G.E. For a while, it could not be decided what kind of status the newborn R.C.A. would have. A public utility position such as the American Telephone & Telegraph, A.T.T. company, was considered. It was decided that R.C.A. would not be allowed to manufacture its own radio equipment. The bulk of American Marconi's management team simply shifted to R.C.A. while retaining their original duties. Little changed for them except the name. Alexanderson would enter the picture from G.E. as chief engineer and implement his system of radio communication. Most notable in the shift was American Marconi's chief managing operator, David Sarnoff. R.C.A. would become Sarnoff and seal the fate of all radio development that followed.

In order that the patents of various corporations could be utilized by the R.C.A. consortium, this consortium needed to expand. On July 20, 1920, cross-licensing of patents was established between G.E., A.T.T. and R.C.A. Lee De-Forest sold out for ~~40~~<sup>25</sup> thousand dollars, and Nikola Tesla and Guglielmo Marconi were left to fight it out among themselves, their patents falling into public domain due to their age. United Fruit, a.k.a. Wireless Speciality Apparatus Co., joins the

consortium but Westinghouse refuses. Westinghouse held Nikola Tesla as a consultant and also held the rights to the very important Armstrong patents. Armstrong would play an important role in making the Alexanderson system a dinosaur. Westinghouse held a good market in radio through its sales to experimenters and radio amateurs. Finally Westinghouse was forced to join in the radio consortium. The R.C.A. consortium in its complete form thus existed on March 25, 1921.

Company	Common Stock	Preferred Stock	Percent
G.E. Co.	\$2,364,826	\$ 620,000	30.1%
Westinghouse	\$1,000,000	\$1,000,000	20.6%
A.T.T.	\$ 500,000	\$ 500,000	10.3%
United Fruit	\$2,000,000	\$ 200,000	4.1%
Misc.	\$1,667,174	\$ 200,000	34.9%

However, the formation of the trust for radio communication did not heed David Sarnoff's music box memo, and left broadcasting out of the picture. David did not forget and to quote a radio historian, "Early radio thus became a battlefield for lawyers and lobbyists as well as inventors, technicians and businessmen." David Sarnoff would reign supreme in this overlooked avenue.

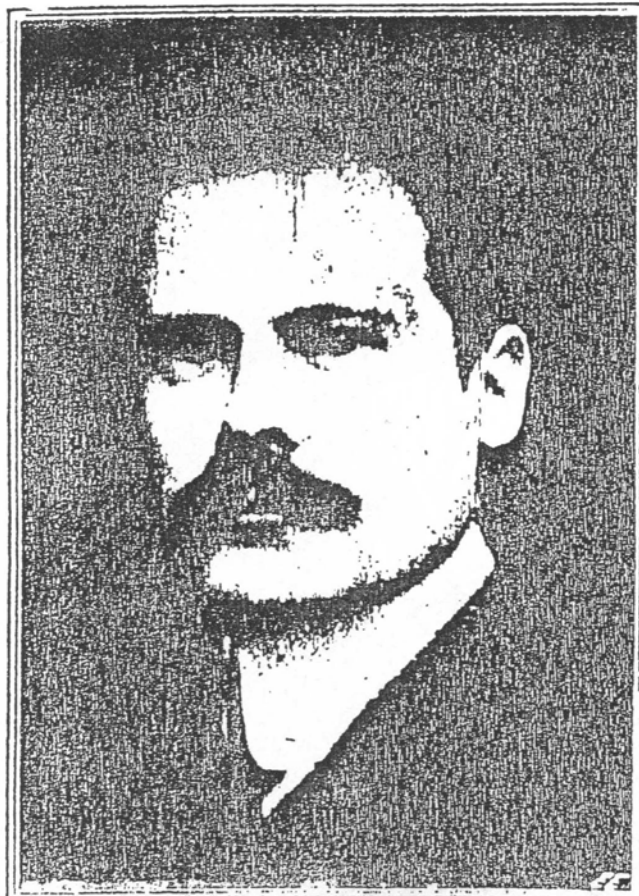

E. F. W. Alexanderson, Well-known Radi and Electrical Engineer, Awarded th "I. R. E." Gold Medal.



Thomson 1853-1937



17, 1891 (the year  
of his birth)



*J. Sarnoff*

*David Sarnoff*

4) David Sarnoff was born on Feb. 27, 1891 (the year Tesla began wireless), in the village of Uzlian, the Province of Minsk, in Russia. David—"Davey" Sarnoff would never know a normal childhood. At age 5 he would begin his long and intensive study of the Talmud, the extensive, arcane book of Jewish doctrine. David Sarnoff migrated from Russia on July 2, 1900, to the gateway of the free world, New York City. It was, however, midsummer, and in the lower Manhattan's Hell's Kitchen, life did not look very inviting compared to the old world village of Uzlan.

David Sarnoff would begin to display his entrepreneurial skill at an early age, 9 years old. With no time for being a child, he had to begin supporting his family, as his father was not in very good health. Thus David began his newspaper business, which would start the path to Marconi. He began the usual paperboy operation, one of heavy competition. The sale of 50 newspapers would yield 25 cents, and a typical sale amounted to 100 papers, equalling a half a dollar per day. The shrewd boy was quick to expand his operation however. He was to gather discarded lumber and bicycle remains in order to fabricate a cart with which to carry bulk supplies of newspapers – this at age 12. A 15-cent delivery fee was charged for use of the cart. Soon his growing operation would employ six other newsboys. Young David's dream was to purchase his own newstand. The obstacle was how to get the required 200 dollars, an absolutely impossible quantity of capital. As if through a miracle, a woman completely unknown to him walked up from nowhere, handed young David 200 bucks, and vanished back into the crowded streets. At age 13 David Sarnoff owned his own business. He would employ his own family, brothers Lew and Morris, his mother, and even his ill father, in his newspaper operation. This stand was located on the corner of 46<sup>th</sup> St. and 10<sup>th</sup> Ave. This was not David Sarnoff's only job. He also earned \$1.50 per week as a musician, singing in a local synagogue each Sunday and for Holy Day events.

Sarnoff wanted to progress further into the newspaper business. His early-age Talmudic studies gave him a particularly strong appreciation of language, words and letters. David wanted now to advance to newspaperman or reporter, for the New York Herald. Fate would send young David in a slightly different direction, albeit a direction that would shape the following century. David Sarnoff applied for work with the Commercial Cable Co., a telegraphic news operation. The noise of numerous telegraph sounders was a fascination to the keen mind of young Sarnoff. In 1906, at age 15, David Sarnoff began work with this company as a bicycle messenger, delivering messages and telegrams (In later years, Sarnoff would require this as a "Rite of Passage" for all prospective employees of R.C.A.). Now Sarnoff has three jobs in multiple newstands, a message boy, and a musician, giving his family a fair income.





DAVID SARNOFF , AGE 5  
WITH MOTHER LEAH



MARCONI'S NEWEST EMPLOYEE





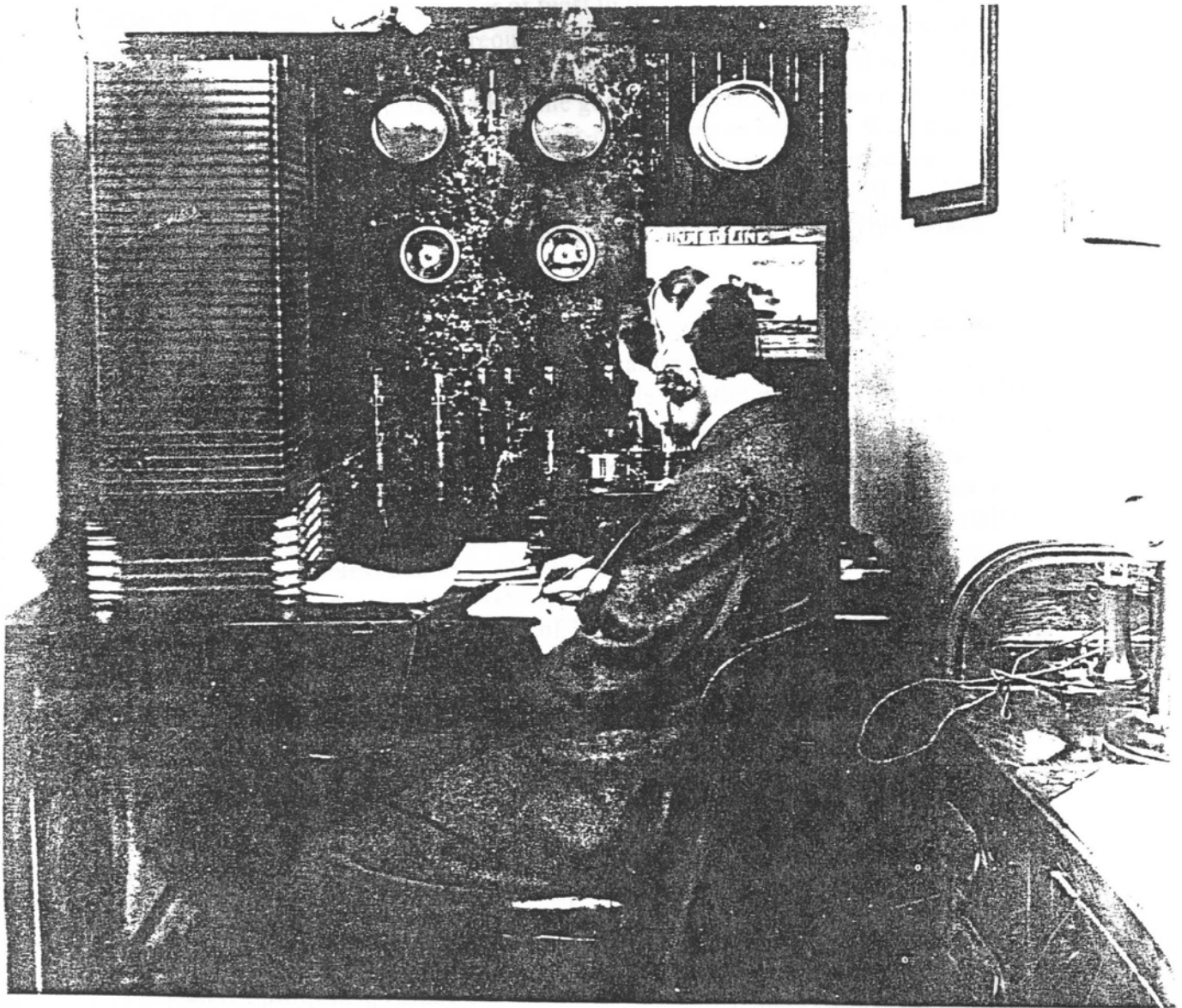

RADIO OPERATOR  
DURING TITANIC  
DISASTER

Young David Sarnoff became increasingly fascinated with the electro-mechanical telegraph. He would purchase a code practice set for two dollars, a device he kept his entire life. David Sarnoff also began gathering books on the subject of electricity. Fate would create another twist in the life of David Sarnoff. A major Christmas event at the synagogue required much of David's time for the event. This would necessitate his absence from his message job. Thus David was fired for his absence. Bad fortune would become good, however. David Sarnoff took on a new job at \$5.50 per week, with the 7-year-old American Marconi Wireless Telegraph Co. His office boy job expanded into his becoming an important employee for this growing company. David Sarnoff's Telegraphic skill quickly grew, with him becoming known as the best "first" in the business. This ranked him with the great T.A. Edison.

David Sarnoff was to begin to create a mythology for himself. He claimed to be the first and foremost operator in the communications involving the Titanic disaster. The Titanic sinking in 1912 was to crystallize the image of wireless in the minds of the public. President W.H. Taft had signed the Wireless Bill in 1905 which required all major vessels to carry the wireless sets. The Titanic was to show the importance of this act and it made Marconi a major hero, netting him a Gold Medal. David Sarnoff sat well in the picture. The year 1912 would see major intervention into wireless and licensing requirements with the beginning of the Department of Commerce. Radio experimenters, or "Hams," were now restricted to operation of the solitary wavelength of 360 meters. The right was now given to the president to close all radio facilities in a "time of war or public peril or disaster."

In 1916 David Sarnoff published his famous "music box memo," predicting the "Home Entertainment Radio Set" for "under 75 dollars." This would be David's Sarnoff's calling in life, and would shape the history of the Radio Corporation of America, with the formation of R.C.A. and Sarnoff shifting into it from American Marconi. His significance within the company would steadily assume greater importance. In 1924 David Sarnoff applied for a commission as a lieutenant colonel in the U.S. Army. This was granted, since R.C.A. was an outgrowth of the U.S. Navy. Sarnoff held dislike for the Navy however, therefore he went to the Army for his military status. In 1929 Sarnoff became rebellious toward then chairman of R.C.A. Owen Young, and the company's submission to the consortium. David's ambitions were much too strong to be held back by such a bureaucratic contrivance. Late in 1929 David Sarnoff, while riding with Elmer Bucher, threw his hat to the floor in a fit, exclaiming he will tolerate submission no more. Sarnoff exclaimed to Owen Young that R.C.A. must unify and begin the manufacture of their own radio equipment or he will quit.



The pressure was on to break the Radio Trust anyway through growing Congressional noise and motions on the part of the U.S. Dept. of Justice (Oct., 1929). Owen Young resigned Jan. 3, 1930. David Sarnoff, at age 38, was now president of the Radio Corp. of America (its 3<sup>rd</sup>), now a free and independent corporation. On Dec. 26, R.C.A. Victor incorporated so as to construct R.C.A. radio sets, and the R.C.A. radiotron radio tube was born, to become the world's finest, still in demand today. R.C.A. Victor was the result of the purchase of the Victor Talking Machine Co. R.C.A.'s new home entertainment radio business now began to greatly surpass the wireless communications business of the company's origin. This business was divided off into Radio Corp. of America

Communications Inc., or R.C.A.C., incorporated on Jan. 3, 1929. R.C.A.C. would hold the wireless communications facilities, such as Bolinas, for an anticipated sell-off to R.C.A. competitor International Telephone & Telegraph, I.T.T. Sarnoff had no further use for wireless. The Alexanderson system was obsolete, and his "music box memo" was now a very profitable reality. This divestment of communications holdings was dropped when the stock market collapsed, foiling the deal with I.T.T. How very much different the Bolinas and P.T. Reyes Station histories would have been if this selling off had actually transpired.

R.C.A. grew into the National Broadcasting Co., N.B.C., a radio network supporting the R.C.A. Victor Home Entertainment Radio Set. R.C.A., in the 1930s era, was the world's foremost radio corporation and David Sarnoff was its head. Sarnoff, of Jewish-Russian background, was the first of powerful American businessmen to advocate hostilities against Germany. At the time the U.S. government did not have a strong love for England, from which it had won its freedom, and Germany was considered to be a powerful ally against the dreaded Soviet Union. Sarnoff rose in rank to Colonel (06) in the U.S. Army, and was promptly made Brigadier General (07) at the outbreak of World War II. R.C.A. was quickly adapted to meet the war effort and R.C.A. staff members were given military rank in order to partake in the war effort. David Sarnoff was placed in command of radio communications for the "D-Day" assault upon the European mainland. Sarnoff would insist upon being called "The General" within the company from this point on. The great R.C.A. would crumble however, with the approach of the 1970s. David Sarnoff lost his health in August of 1968, and began transfer of rule to his son Robert. R.C.A. would slowly die under Robert Sarnoff. David Sarnoff was a character of the old world, and his son cared little for these old world values. Robert was to insist upon elimination of the name Radio Corporation of America, substituting just R.C.A. He went so far, to his father's dismay, as to alter the arch-typical R.C.A. logo. Mid-day in the Bolinas lunchroom on Dec. 11, 1971, the order wire teletype printed the following message: David Sarnoff has died. David Sarnoff died at his home at 11:50 a.m. E.S.T., at the age of 80. From that point on his great corporation disintegrated.

6) Throughout the 1920s, R.C.A. had control of all major radio patents: the De-Forest Audion, the Armstrong Superhet, and sundry Marconi devices, to name but a few. R.C.A. held to the conditions existing during the period of its creation when the U.S. government froze the wireless telegraph. Radio was now frozen solid by R.C.A. All would pay R.C.A. for license agreements to make or use radios for commercial purposes. The motto: We Don't Pay Royalties, We Collect Them. But like the despicable Tesla patents, the Farnsworth patents were all-inclusive and un-improvable. T.V. had solid patent protection. Sarnoff would involve Farnsworth in lengthy and costly patent litigation, thereby wearing him down. Through this means, Sarnoff was to delay the use of television for twenty years until R.C.A. could have control. Next to assault the R.C.A. icon was their own Edwin Armstrong. Armstrong was to develop the heterodyne system of radio reception, the very heart of the modern radio set. He is the father of today's radio receiver. Armstrong was given ample opportunity for experimentation by Sarnoff. In the course of his experiments with modulation techniques, Armstrong was to develop his frequency modulation system (F.M.). The enhancement in performance over amplitude modulation (A.M.) was remarkable. This was the beginning of high fidelity, or Hi-Fi. R.C.A. was not happy to see their A.M. Home Entertainment Set become obsolete so soon after their establishment. Sarnoff would reject Armstrong's invention. It was of no interest to R.C.A. Armstrong would take F.M. and develop it on his own with his Yankee network. But R.C.A. owned Armstrong's radio circuits and would not allow him to use them on his own. Sarnoff would get the Federal Communication Commission to change Armstrong's frequencies to shut him down. The good friends were now bitter enemies. Armstrong and Sarnoff would engage in head-on litigation for over a decade, finally resulting in Armstrong jumping to his death from his 13<sup>th</sup> story apartment. "I did not kill Armstrong," headlined Sarnoff. F.M. would be delayed for a decade until R.C.A. could control it. Tesla, Marconi and Armstrong, were all gone. Left were a feeble De-Forest, and Farnsworth was making wooden crates for the Army. Under General David Sarnoff, R.C.A. would enter the post-war period as the inventor of the T.V. and Hi-Fi, taking credit for all.



7) Postwar, R.C.A. was a truly impressive operation, holding an archetypical logo. Its engineering practices were second only to the Bell system. The home entertainment markets of R.C.A. Victor expanded into washers, dryers and cooking appliances with R.C.A. Whirlpool. The R.C.A. broadcast equipment was of unmatched quality and performance. R.C.A.C. global transmission facilities carried the business traffic of the world, and radiomarine corporation stations KPH and WCC carried most ship-to-shore traffic. Most military gear displayed the R.C.A. logo. Sarnoff was to lead a truly corporate masterpiece. But ultimately R.C.A. was a frozen megalith, victim of its own deeds. The San Francisco crowd ran circles around R.C.A., creating electron tubes vastly superior to those of R.C.A., such as the Eimac Power Tetrode series. They would create world famous particle accelerators such as S.L.A.C., and Farnsworth would create the world's first controlled fusion reaction, producing many kilowatts of power, and this with no more than a fancy radio tube (fig. 23).

*J.B. Jr.*  
Then came Ampex and its magnetic video tape recorder and the digital computer. It was all going too fast for R.C.A. The West Coast was in power now. R.C.A. had become the scourge of the inventive spirit and no talent would be available to it. Prospective engineers (like the author) would have to deliver telegrams on bicycles to show that they could follow in the footsteps of the great Sarnoff. Modern talent had no time for this. The shifts from tube to transistor, from shortwave to satellite, and from broadcast to cable, left old R.C.A. far behind. It still held fast to the Marconi plants but never understood what they really meant. And like Tesla, Edison, Thompson, Murgas, De-Forest, Armstrong, Marconi, and back all the way to Galvani, David Sarnoff was to see his dreams drift out of his hands. At the time of his death the great Bolinas and Rocky Point R.C.A.C. facilities were slated for destruction, by his own offspring. The faltering satellite business was sold off. R.C.A. radiotrons were made as junk. N.B.C. was sold to G.E. and Home Appliance went to Black and Decker. All was gone. R.C.A. was pronounced dead on Dec. 11, 1985 and in June, 1986, General Electric retrieved the remains of its once great child, and buried them in a toxic waste dump.

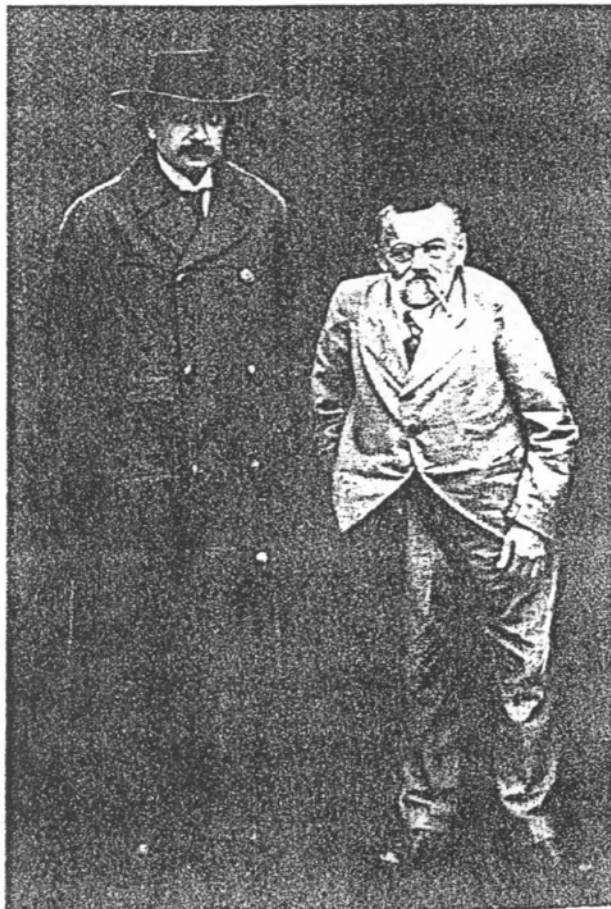

Steinmetz, Einstein, and company inspecting the RCA radio station at New Brunswick, New Jersey, 1921. Source: Sarnoff Library, Princeton, N.J.

Retouched photograph of Steinmetz and Einstein, 1924. Source: Hall of History Foundation, Schenectady, N.Y. NO TESLA.





Courtesy General Electric Company

*Charles Proteus Steinmetz*



Steinmetz, about 1890. Source: Hall of History Foundation, Schenectady, N.Y.





T. A. EDISON  
AGE 23

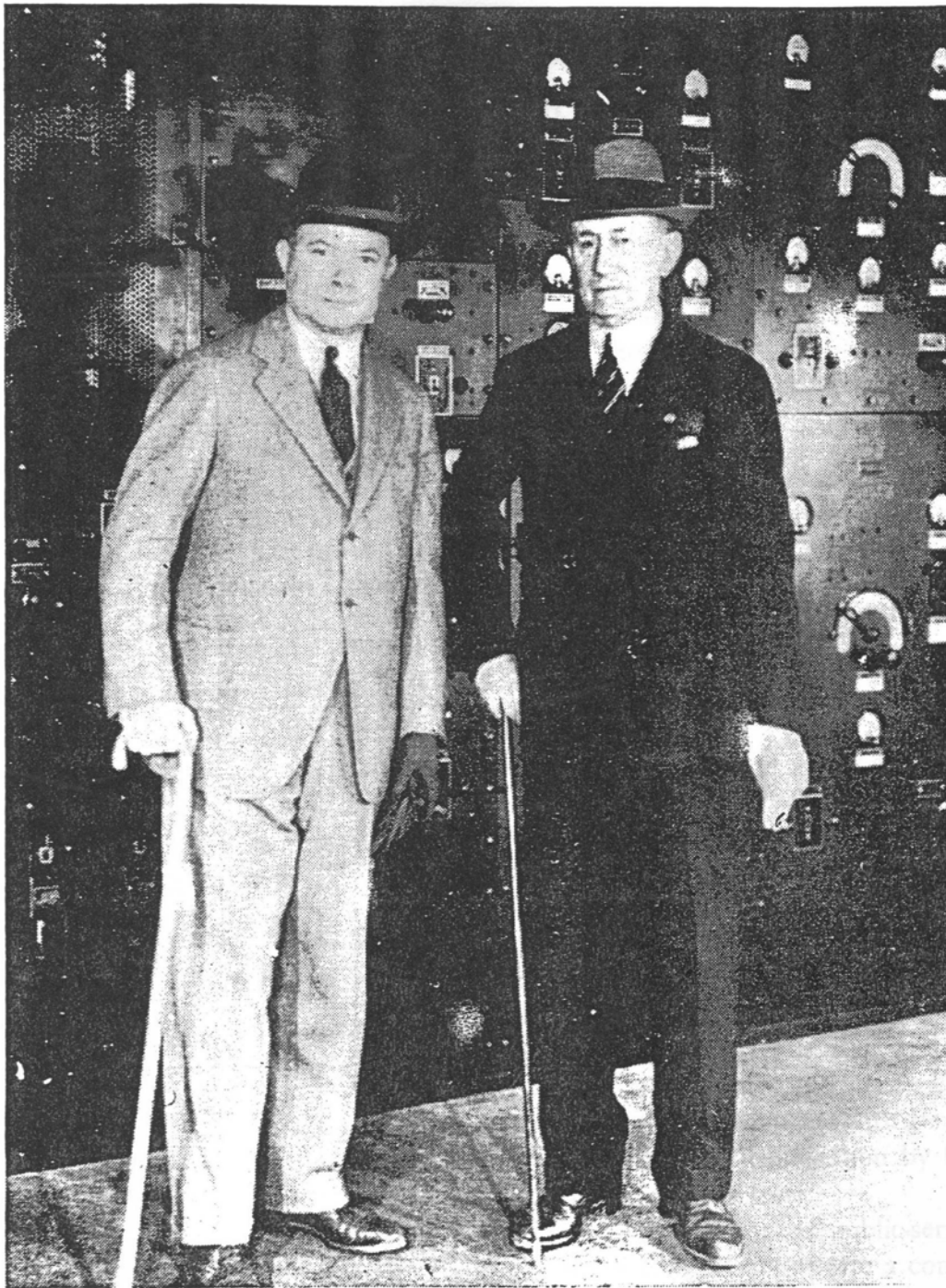

DAVID  
SARNOFF

GUGLIELMO  
MARCONI

R.C.A. TYPE  
E  
EXCITER IN  
BACK



## THE ISSUE OF GOVERNMENT CONTROL

*Editor's Note* In November, 1916, a plan was placed before Congress for authorizing the Navy to operate radio stations in competition with private industry even in peacetime. Under this program, rates and traffic would be regulated by the government, which was apparently seeking control of the radio communications field. Sarnoff testified before the Committee in his capacity as Secretary of the Institute of Radio Engineers.

### Free Enterprise in Communications

Statement before Interdepartmental Committee on  
Radio Legislation of Congress  
Washington, D.C., November 21, 1916, BY DAVID SARNOFF

Many important problems in radiotelegraphy and telephony are still unsolved—as, for example, the problems of long-range radiotelephony, adequate selective reliability, call systems, and the elimination of atmospheric strays.

The solution of these important problems calls for the highest engineering and inventive talent and research. Such inventive effort and research can only exist under free institutions and under the stimulus of healthy competition.

Certain foreign governments have assisted, and not opposed, individual initiative and private enterprise in developing the radio communications systems of their countries with great success.

Government competition, or confiscation by the government, would effectively stifle inventive efforts.

The military control of radio, or any public-service communications, in times of peace virtually constitutes a continuous military inquisition into private correspondence, an undemocratic and dangerous institution.

The reliability and superiority of our radio communications in times of sudden national peril are dependent upon the inventive

and engineering resources of the nation, which should, therefore, be kept at the highest pitch and the broadest scope.

The Board of Direction of the Institute of Radio Engineers is opposed to the competition by any department of the government, and particularly by any military or naval department, with existing organizations founded for radio communication.

BOARD OF DIRECTION, INSTITUTE OF RADIO ENGINEERS  
by *David Sarnoff*, Secretary

(Book: *Radio and David Sarnoff*, by E. E. Bucher, part 1,  
pp. 148-149.)

FREE  
ENTERPRISE IN  
COMMUNICATIONS

## Opposing a Navy Wireless Monopoly

Testimony before Congressional Committee on the  
Merchant Marine and Fisheries  
Hearings to regulate radio communications  
Washington, D.C., December 12, 1918

The passage of this bill (H.R. 13,159) would stifle the development of the radio art. Those testifying on behalf of this bill apprehended that the opponents of the bill would contend that its passage and enactment in the law would stifle the growth and development of the radio art, and well were they justified in their apprehension.

Not only do we contend that such would be the case, but we honestly and firmly believe it to be true. It may be said of us that we are commercial men and, as such, our opinion on this subject is perhaps not an impartial one. But what can be said of the opinion of the technical man and the inventor—who, the naval officer asks us to believe, would fare better under a government ownership and naval monopoly of radio communication than he does at present? Why do not these technical men and inventors employed by commercial companies, here described as victims of the present system, come before you and urge the passage of this bill and the creation of a government monopoly? And more significant still, what are the views and opinions expressed by independent scientists and inventors, whose long experience in the fields of discovery and invention

11



WIRELESS  
COMMUNICATIONS

have qualified them to speak authoritatively on this all-important phase of the question? . . .

It should also be recognized that most of the inventions and improvements . . . have been made by the practical and technical men employed by the various commercial interests concerned with the operation of radio stations. . . .

Actual operating conditions at the stations, and especially with the equipment employed, form in most cases the basis upon which new thought, new ideas, were founded which have resulted in invention and improvement. If the Navy Department is given a monopoly over the operation of all radio stations in this country, where will these outside technical experts obtain their further experience and knowledge of actual operating conditions?

(Book: *Radio and David Sarnoff*, by E. E. Bucher, part 1, pp. 189-191A.)

## Continuing Fight against Navy Wireless Monopoly

Statement before the Senate Committee on Naval Affairs  
Hearings on government ownership of communications  
Washington, D.C., October 9, 1919

I have had the privilege of attending all previous hearings of the Committee on this subject . . . but I have not come prepared to discuss this bill, which was only introduced yesterday.

However, it seems to me that the bill is so far-reaching in its scope and so all-important to the general subject of radio communication that a great deal of attention should be given to it before it is enacted into legislation, if it is to become a law.

Throughout the hearings before this Committee and before the committees of the House which have dealt with this subject, it was apparent that Congress is opposed to giving the Navy Department a monopoly of radio communication. In other words, government ownership is objectionable.

12 Now this bill, in my judgment, will result in time in precisely the thing that Congress had evidenced its opposition to, and my

in the early 30s

reasons for entertaining such opinion I shall be very glad to state. In the first place, competition by the Navy Department without restriction, such as this bill proposes, is unnecessary and unwarranted. In the second place, the government is not subject to the same conditions as govern the operation of private companies, and therefore competition with the government is just as impracticable and just as impossible in radio as it is in any other business.

CONTINUING  
FIGHT AGAINST  
NAVY WIRELESS  
MONOPOLY

No provision is made here as to rates, the authority for which is vested in the Secretary of the Navy. So it is a comparatively simple matter for the Navy Department to introduce rates for the service which would result in private companies going out of business; and thus instead of directly, we would indirectly come to government ownership and government monopoly of radio communication. . . .

This bill (S-3177) would at once permit the Navy Department to handle commercial business on the Atlantic Coast as well as on the Pacific Coast and with South America—in fact, anywhere else where the Navy is able to communicate. And it seems to me that if this bill becomes a law, private enterprise would, and in my judgment should, hesitate a long time before investing a dollar in a commercial wireless company.

. . . All the legislation which is now being proposed for wavelength control, or communication control, points in the same direction, namely, the greatest freedom and the greatest control to government agencies and government stations. Therefore, if private enterprise does not have the same freedom in the matter of operation and in the matter of wavelengths, it could not withstand the competition from the government if rates were dropped to a point where private operation would be unprofitable.

(Book: *Radio and David Sarnoff*, by E. E. Bucher, part 1, pp. 223-223A.)

*Congressional interest in government operation of radio communications declined in the fall of 1919, and the proposed legislation was abandoned.*

Editor's Note



Since those first broadcasts in the early 1920s, one of the prime functions of radio has always been the coverage of important current happenings—from political speeches and debates to sporting events. Today, this function has been enlarged and extended. From the purely national scene, American radio now reaches out across the oceans. The Voice of America, proposed by Sarnoff in 1943, broadcasts all over the world, fighting “the battle between truth and falsehood . . . to make it possible for people everywhere to know the truth.”

RADIO  
BROADCASTING

### “Radio Music Box”

Memorandum to Edward J. Nally, Vice-president and General Manager  
Marconi Wireless Telegraph Company of America  
Sept. 30, 1915

I have in mind a plan of development which would make radio a “household utility” in the same sense as the piano or phonograph. The idea is to bring music into the house by wireless.

While this has been tried in the past by wires, it has been a failure because wires do not lend themselves to this scheme. With radio, however, it would seem to be entirely feasible. For example, a radiotelephone transmitter having a range of, say, 25 to 50 miles can be installed at a fixed point where instrumental or vocal music or both are produced. The problem of transmitting music has already been solved in principle, and therefore all the receivers attuned to the transmitting wavelength should be capable of receiving such music. The receiver can be designed in the form of a simple “Radio Music Box” and arranged for several different wavelengths, which should be changeable with the throwing of a single switch or pressing of a single button.

The “Radio Music Box” can be supplied with amplifying tubes and a loudspeaking telephone, all of which can be neatly mounted in one box. The box can be placed on a table in the parlor or living room, the switch set accordingly, and the transmitted music received. There should be no difficulty in receiving music perfectly

31

RADIO  
BROADCASTING

when transmitted within a radius of 25 to 50 miles. Within such a radius, there reside hundreds of thousands of families; and as all can simultaneously receive from a single transmitter, there would be no question of obtaining sufficiently loud signals to make the performance enjoyable. The power of the transmitter can be made 5 kilowatts, if necessary, to cover even a short radius of 25 to 50 miles, thereby giving extra-loud signals in the home if desired. The use of head telephones would be obviated by this method. The development of a small loop antenna to go with each "Radio Music Box" would likewise solve the antenna problem.

News by Radio  
Predicted

The same principle can be extended to numerous other fields—as, for example, receiving lectures at home which can be made perfectly audible; also, events of national importance can be simultaneously announced and received. Baseball scores can be transmitted in the air by the use of one set installed at the Polo Grounds. The same would be true of other cities. This proposition would be especially interesting to farmers and others living in outlying districts removed from cities. By the purchase of a "Radio Music Box," they could enjoy concerts, lectures, music, recitals, etc., which might be going on in the nearest city within their radius. While I have indicated a few of the most probable fields of usefulness for such a device, yet there are numerous other fields to which the principle can be extended. . . .

The manufacture of the "Radio Music Box," including antenna, in large quantities would make possible their sale at a moderate figure of perhaps \$75 per outfit. The main revenue to be derived would be from the sale of "Radio Music Boxes," which, if manufactured in quantities of a hundred thousand or so, could yield a handsome profit when sold at the price mentioned above. Secondary sources of revenue would be from the sale of transmitters. . . .

\$75 Million in Sales  
Foreseen

32

The company would have to undertake the arrangements, I am sure, for music recitals, lectures, etc., which arrangements can be satisfactorily worked out. It is not possible to estimate the total amount of business obtainable with this plan until it has been de-



veloped and actually tried out, but there are about 15 million families in the United States alone, and if only 1 million, or 7 percent of the total families, thought well of the idea, it would, at the figure mentioned, mean a gross business of about \$75 million, which should yield considerable revenue.

“RADIO  
MUSIC BOX”

Aside from the profit to be derived from this proposition, the possibilities for advertising for the company are tremendous, for its name would ultimately be brought into the household, and wireless would receive national and universal attention.

(Book: *Radio and David Sarnoff*, by E. E. Bucher, part 1, pp. 123-125.)

## Radio's Business Growth

Memorandum to E. W. Rice, Jr., President  
General Electric Company  
March 3, 1920

The “Radio Music Box” proposition (regarding which I reported to Mr. Nally in 1915 and to Mr. Owen D. Young on January 31, 1920) requires considerable experimentation and development, but having given the matter much thought, I feel confident in expressing the opinion that the problems involved can be met. With reasonable speed in design and development, a commercial product can be placed on the market within a year or so.

Should this plan materialize, it would seem reasonable to expect sales of 1 million “Radio Music Boxes” within a period of three years. Roughly estimating the selling price at \$75 per set, \$75 million can be expected. This may be divided approximately as follows:

1st year	100,000	Radio Music Boxes	\$ 7,500,000
2nd year	300,000	Radio Music Boxes	22,500,000
3rd year	600,000	Radio Music Boxes	45,000,000
		Total	<u>\$75,000,000</u>

*Editor's Note* RCA's actual sales of Radio Music Boxes during the first three years of its activities in this field were as follows:

1st year	1922:	\$11,000,000
2nd year	1923:	22,500,000
3rd year	1924:	50,000,000
	Total	<u>\$83,500,000</u>

(Book: *Radio and David Sarnoff*, by E. E. Bucher, part 1, pp. 234-235.)

## The First Major Sports Broadcast

Reports on radio broadcast of  
Dempsey-Carpentier world's heavyweight championship fight  
*The Saturday Evening Post*, Aug. 7, 1926  
*Reader's Digest*, December, 1955

*Editor's Note* At the broadcast of the Dempsey-Carpentier championship match in Jersey City on July 2, 1921, Major J. Andrew White, who was then the editor of the RCA publication, *Wireless Age*, was the announcer. David Sarnoff was at his elbow to assist in the description through the microphone of station WJY, temporarily installed by RCA at Hoboken, N.J.

In later years, Sarnoff and White both published accounts in popular magazines of that notable broadcasting event.

Following are excerpts from the reminiscences of J. Andrew White, written for the *Reader's Digest* in December, 1955.

### A Crazy Experiment

. . . This experiment, frowned upon as "just plain crazy" by financiers, had been built on the enthusiastic dream of young David Sarnoff. To pull it off, Sarnoff and I had scrounged \$1,500 from a special account of the then new Radio Corporation of America.

The cheerfully stubborn Sarnoff first suggested sending entertainment and information over the air in 1915, when he was twenty-four. The American Marconi Company, for which he was assistant traffic manager, had been so skeptical that its board of directors  
34 laughed heartily when it turned thumbs down on his idea.



*SETTING UP FOR BROADCAST*

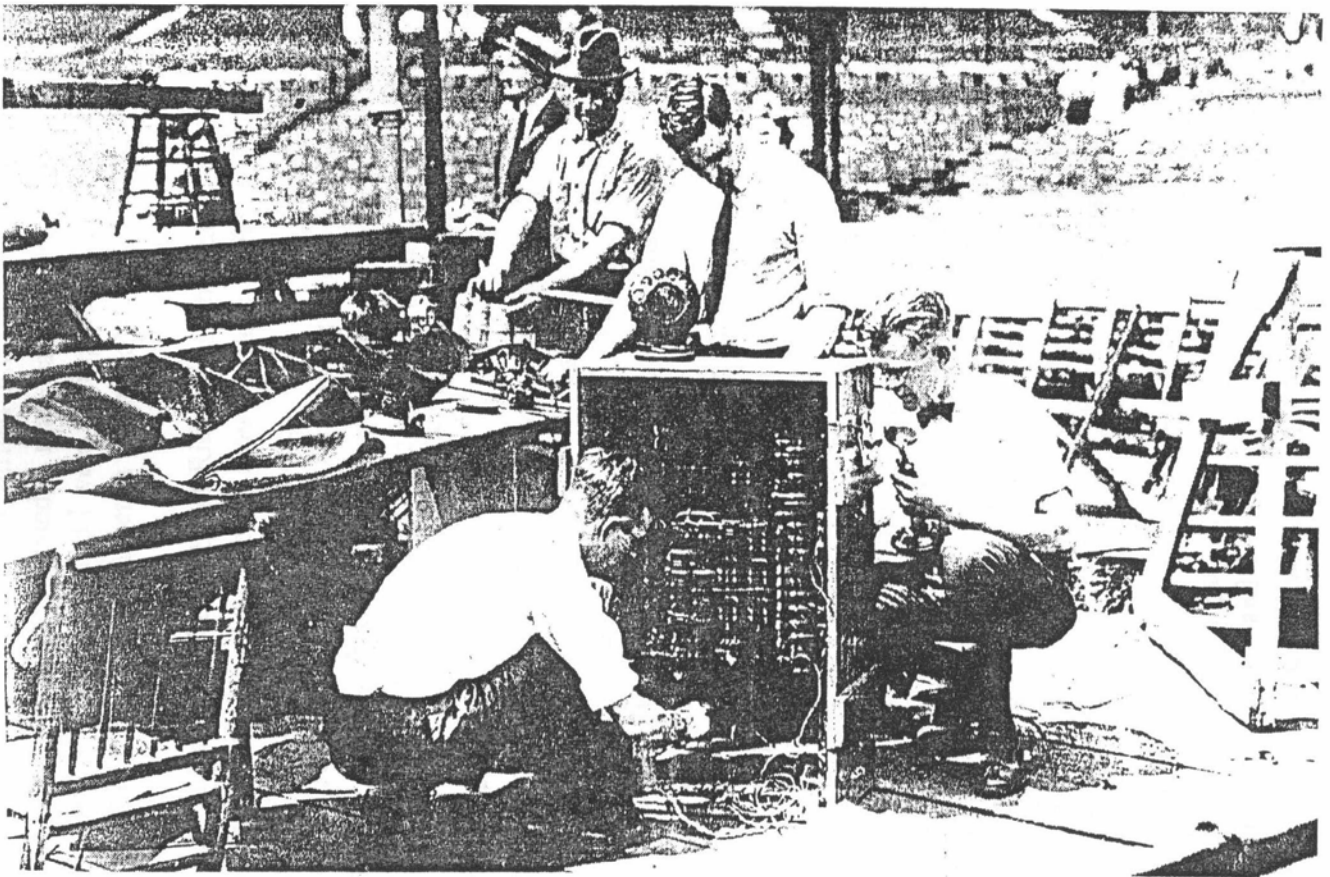

NATIONAL MUSEUM OF AMERICAN HISTORY

. . . Each time Sarnoff brought up the subject—which he did frequently—our company management (called, from 1919 onward, the Radio Corporation of America) turned him down. Then in 1921, his luck turned. As it happened, a man named Tex Rickard opened the door. While Sarnoff and I were talking about radio, promoter Rickard had Europe and America talking about the coming prizefight. . . .

Millions wanted to see the fight, but Rickard's arena seated only 91,000. If we could offer it on the air blow-by-blow while it was happening, we would have a vast audience.

We lacked several things, however—including money. Then Sarnoff, digging into his books as a general manager, discovered \$2,500 of RCA money in accumulated rentals of ship wireless equipment. "Take it," he said to me. Then he added cautiously, "But don't spend a nickel more than \$1,500!" . . .

Now we needed some public support in high places. If our broadcast could be made a charity "benefit," that might turn the trick. Anne Morgan, daughter of the banker J. P. Morgan, headed the American Committee for Devastated France, and young Franklin Roosevelt was president of the Navy Club. Would they join forces with us? Soon Sarnoff announced that these two organizations would get a share of the gate receipts wherever crowds paid admissions to hear the radio broadcast. . . .

I was at ringside early on July 2, testing. From the railroad shack at the other end of my telephone line, Owen Smith reported *all well*: crowds were already gathering outside the theaters, and my signal was coming in fine.

Finally, Dempsey, in his ragged red sweater, and the pale Carpentier, in a gray silk Japanese kimono, were in the ring. . . . That was when I said, "Ladies and gentlemen, . . ." to begin the first big radio broadcast.

. . . In the fourth round, Dempsey, bigger and more solidly built, waded in to finish the fight. . . .

In a few minutes, Sarnoff and I were looking at a terse cablegram from RCA's president, who was vacationing in London. "You have made history," it said.

We were tired and bleary-eyed, but in our minds' eyes, Sarnoff-



RADIO and I were seeing the crowds that were pouring out of theaters and  
BROADCASTING halls in Pittsburgh and St. Augustine, Boston and Washington, Albany, Philadelphia, and Akron, their ears full of a modern miracle. We knew then that the era of radio for the millions had begun.

(Photostat of text: "The First Big Radio Broadcast," by J. Andrew White, *Reader's Digest*, December, 1955; David Sarnoff Library, Princeton, N.J.)

*Editor's Note* In the August 7, 1926, issue of *The Saturday Evening Post*, David Sarnoff recalled his impressions of the Dempsey-Carpentier fight.

**A High-water Mark in Broadcasting** A feature of radio that early drew the man of the house toward what at first he was inclined to regard as a plaything was the prospect of hearing descriptions of his favorite athletic events broadcast by expert announcers. The pioneer in this field, so far as I know, was J. Andrew White, who, on July 2, 1921, announced the Dempsey-Carpentier fight from the ringside in Jersey City.

White worked out a scheme to equip theaters throughout the Middle Atlantic States to receive a blow-by-blow description of the battle, which he sent by way of a temporary station constructed at Hoboken. He had to use makeshift paraphernalia and trust to luck. Two nights before the fight, he called me up.

"Well, I'm in the soup," he announced cheerfully. "So far, we haven't been able to get a sound to register beyond Newark. We are averaging a complaint a minute just now."

That night, with White sick from worry, whatever was wrong with his transmission system—and he doesn't know to this day what that was—righted itself, and his patrons were able to assure those to whom they had sold tickets for listening in to the event that the show would come off as planned.

My remembrance of that fight is vivid. I went with White to his place at the ringside. It was a torrid day, and we all fried slowly in the sun. White was dripping with perspiration, and his throat was parched. In the excitement, a boy who had been brought along expressly to supply him with iced water forgot all about his duty, and when White, who could not speak except in his role of announcer,

signaled for the vacuum bottle containing the precious fluid, the boy merely cried, "Yes, ain't it a bully fight!"

THE FIRST  
MAJOR SPORTS  
BROADCAST

An exciting feature of the day for radio was that one news agency scooped the whole journalistic world by wireless. The reporter who had been listening to White at a downtown office flashed the word of Dempsey's victory by radio to Paris and, in spite of the many cables which had been leased by powerful newspapers, beat everybody by thirty-three seconds.

As a dramatic ending to the fight, the very instant that White finished pronouncing the words, "Dempsey remains the champion of the world," his transmitting set went smash. He could not have sent another syllable over it.

It was estimated that nearly 400,000 persons attended the Dempsey-Carpentier fight by proxy. This number seems infinitesimal in view of the millions who would listen in on a similar event now, but it was a high-water mark for those days and pointed the way to the prospective popularity of at least one kind of broadcasting.

(Photostat of text: "Radio," by David Sarnoff, as told to Mary Margaret McBride, *The Saturday Evening Post*, Aug. 7, 1926; David Sarnoff Library, Princeton, N.J.)

*By the beginning of 1922, RCA was in the "Radio Music Box" business, and by the end of that year, their sales had totaled \$11 million. Letting others settle into the profitable present, David Sarnoff continued to focus on the future. Perhaps more than anyone else, he saw the possibilities in this infant industry.*

Editor's Note

## Union of Radio and Phonograph

Memorandum to RCA management  
April 10, 1922

The radiotelephone, as a receiver of broadcast material, steps out of the role formerly played by a telephone instrument—namely, that of being part of a two-way communicating system, usually for tolls

37



ARMY  
COLONEL



"GENERAL"  
DAVID  
SARNOFF





FARNSWORTH & HIS  
FIRST TELEVISION  
WORK, CAMERA TUBE  
ON LEFT, PICTURE TUBE  
ON RIGHT



ZWORYKIN  
&  
PICTURE  
TUBE

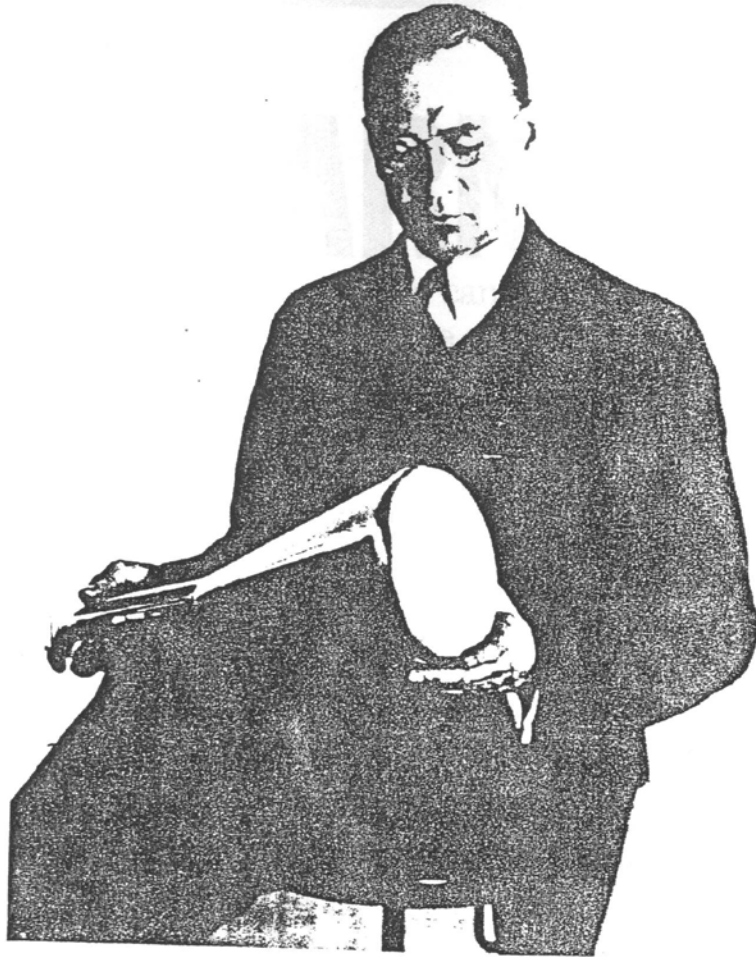

ZWORYKIN  
&  
"ICONOSCOPE"  
R.C.A.  
CAMERA  
TUBE



**ELECTRICAL ENGINEER**

# PHILO FARNSWORTH

The key to the television picture tube came to him at 14, when he was still a farm boy, and he had a working device at 21. Yet he died in obscurity

By NEIL POSTMAN

**F**or those inclined to think of our fading century as an era of the common man, let it be noted that the inventor of one of the century's greatest machines was a man called Phil. Even more, he was actually born in a log cabin, rode to high school on horseback and, without benefit of a university degree (indeed, at age 14), conceived the idea of electronic television—the moment of inspiration coming, according to legend, while he was tilling a potato field back and forth with a horse-drawn harrow and realized that an electron beam could scan images the same way, line by line, just as you read a book. To cap it off, he spent much of his adult life in a struggle with one of

America's largest and most powerful corporations. Our kind of guy.

I refer, of course, to Philo Taylor Farnsworth. The "of course" is meant as a joke, since almost no one outside the industry has ever heard of him. But we ought not to let the century expire without attempting to make amends.

Farnsworth was born in 1906 near Beaver City, Utah, a community settled by his grandfather (in 1856) under instructions from Brigham Young himself. When

Farnsworth was 12, his family moved to a ranch in Rigby, Idaho, which was four miles from the nearest high school, thus necessitating his daily horseback rides. Because he was intrigued with the electron and electricity, he persuaded his chemistry teacher, Justin Tolman, to give him special instruction and to allow him to audit a senior course. You could read about great scientists from now until the 22nd century and not find another instance where one of them celebrates a high school teacher. But Farnsworth did, crediting Tolman with providing inspiration and essential knowledge.

Tolman returned the compliment. Many years later, testifying at a patent interference case, Tolman said Farnsworth's explanation of the theory of relativity was the clearest and most concise he had ever heard. Remember, this would have been in 1921, and Farnsworth would have been all of 15. And Tolman was not the only one who recognized the young student's genius.

With only two years of high school behind him, and buttressed by an intense autodidacticism, Farnsworth gained admission to Brigham Young University.

The death of his father forced him to leave at the end of his second year, but, as it turned out, at no great intel-

lectual cost. There were, at the time, no more than a handful of men on the planet who could have understood Farnsworth's ideas for building an electronic-television system, and it's unlikely that any of them were at Brigham Young. One such man was Vladimir Zworykin, who had emigrated to the U.S. from Russia with a Ph.D. in electrical engineering. He went to work for Westinghouse with a dream of building an all-electronic television system. But he wasn't able to do so. Farnsworth was. But not at once.

He didn't do it until he was 21. By then, he had found investors, a few assistants and a loving wife ("Pem") who assisted him in his research. He moved to San Francisco and set up a laboratory in an empty loft. On Sept. 7, 1927, Farnsworth painted a square of glass black and scratched a straight line on the center. In another room, Pem's brother, Cliff Gardner, dropped the slide between the Image Dissector (the camera tube that Farnsworth had invented earlier that year) and a hot, bright, carbon arc lamp. Farnsworth, Pem and one of the investors, George Everson, watched the receiver. They saw the straight-line image and then, as Cliff turned the slide 90°, they saw it move—which is to say they saw the first all-electronic television picture ever transmitted.

History should take note of Farnsworth's reaction. After all, we learn in school that Samuel Morse's first telegraph message

FARNSWORTH HOLDS HIS "TELEVISION TRANSMISSION TUBE," A FORERUNNER OF THE MODERN TV CAMERA, CIRCA 1939

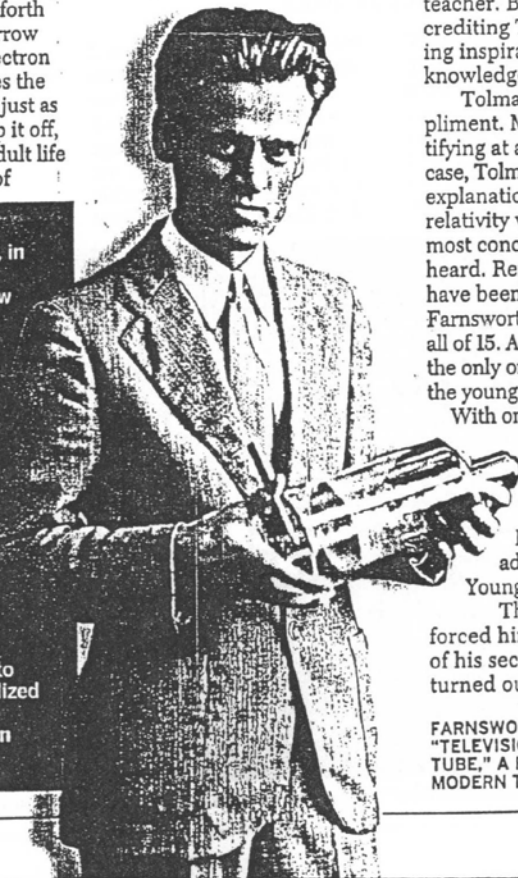

**BORN** Aug. 19, 1906, in Indian Creek, Utah  
**1921** Has idea for how to create images using electrons  
**1927** Transmits first electronic image  
**1934** Stages first demonstration of his TV system  
**1935** U.S. Patent Office awards "priority of invention"  
**1939** After seven years of litigation, RCA agrees to pay him royalties  
**1947** Patents begin to expire; he is hospitalized for depression  
**1971** Dies March 11 in Holladay, Utah



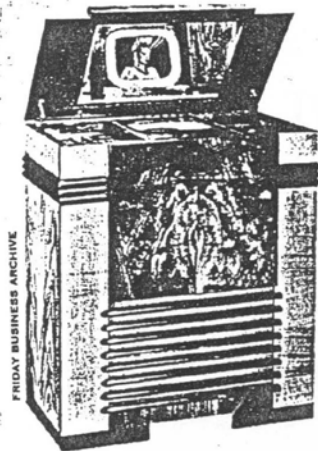

FRIDAY BUSINESS ARCHIVE

EARLY SETS LIKE THIS ONE HAD A BACKWARD PICTURE THAT HAD TO BE VIEWED IN A MIRROR

was "What hath God wrought?" Edison spoke into his phonograph, "Mary had a little lamb." And Don Ameche—I mean, Alexander Graham Bell—shouted for assistance: "Mr. Watson, come here, I need you!" What did Farnsworth exclaim? "There you are," said Phil, "electronic television." Later that evening, he wrote in his laboratory journal: "The received line picture was evident this time." Not very catchy for a climactic scene in a movie. Perhaps we could use the telegram George Everson sent to another investor: "The damned thing works!"

At this point in the story,

things turn ugly. Physics, engineering and scientific inspiration begin to recede in importance as lawyers take center stage. As it happens, Zworykin had made a patent application in 1923, and by 1933 had developed a camera tube he called an Iconoscope. It also happens that Zworykin was by then connected with the Radio Corporation of America, whose chief, David Sarnoff, had no intention of paying royalties to Farnsworth for the right to manufacture television sets. "RCA doesn't pay royalties," he is alleged to have said, "we collect them."

And so there ensued a legal battle over who invented television. RCA's lawyers contended that Zworykin's 1923 patent had priority over any of Farnsworth's patents, including the one for his Image

Dissector. RCA's case was not strong, since it could produce no evidence that in 1923 Zworykin had produced an operable television transmitter. Moreover, Farnsworth's old teacher, Tolman, not only testified that Farnsworth had

conceived the idea when he was a high school student, but also produced the original sketch of an electronic tube that Farnsworth had drawn for him at that time. The sketch was almost an exact replica of an Image Dissector.

In 1934 the U.S. Patent Office rendered its decision, awarding priority of invention to Farnsworth. RCA appealed and lost, but litigation about various matters continued for many years until Sarnoff finally agreed to pay Farnsworth royalties.

But he didn't have to for very long. During World War II, the government suspended sales of TV sets, and by the war's end, Farnsworth's key patents were close to expiring.

house in Maine, suffering from depression, which was made worse by excessive drinking. He had a nervous breakdown, spent time in hospitals and had to submit to shock therapy. And in 1947, as if he were being punished for having invented television, his house in Maine burned to the ground.

One wishes it could be said that this was the final indignity Farnsworth had to suffer, but it was not. Ten years later, he appeared as a mystery guest on the television program *What's My Line?* Farnsworth was referred to as Dr. X and the panel had the task of discovering what he had done to merit his appearance on the show. One of the panelists asked Dr. X if he had invented some kind of a machine that might be painful

“He was an American original, brilliant, idealistic, undaunted by obstacles.”

DAVID MCCULLOUGH, on the PBS television show *The American Experience*

When they did, RCA was quick to take charge of the production and sales of TV sets, and in a vigorous public-relations campaign, promoted both Zworykin and Sarnoff as the fathers of television. Farnsworth withdrew to a

when used. Farnsworth answered, "Yes. Sometimes it's most painful." He was just being characteristically polite. His attitude toward the uses that had been made of his invention was more ferocious. His son Kent was once asked what that attitude was. He said, "I suppose you could say that he felt he had created kind of a monster, a way for people to waste a lot of their lives." He added, "Throughout my childhood his reaction to television was 'There's nothing on it worthwhile, and we're not going to watch it in this household, and I don't want it in your intellectual diet.'"

So we may end Farnsworth's story by saying that he was not only the inventor of television but also one of its earliest and most perceptive critics.

Neil Postman is the Paulette Goddard Professor of Media Ecology at New York University

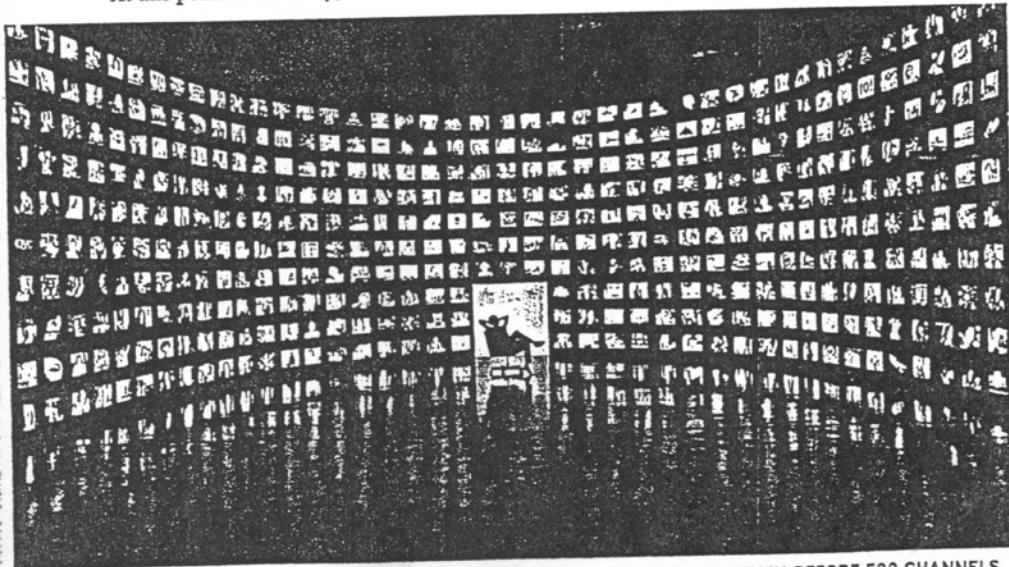

FARNSWORTH WASN'T THRILLED WITH WHAT WAS ON TV—AND THAT WAS EVEN BEFORE 500 CHANNELS



The readership of the San Francisco Chronicle added a new word to their vocabularies when they read the feature headline in the morning edition on Sept. 3, 1928:

## SF MAN'S INVENTION TO REVOLUTIONIZE TELEVISION



T.V.  
MAN  
1928

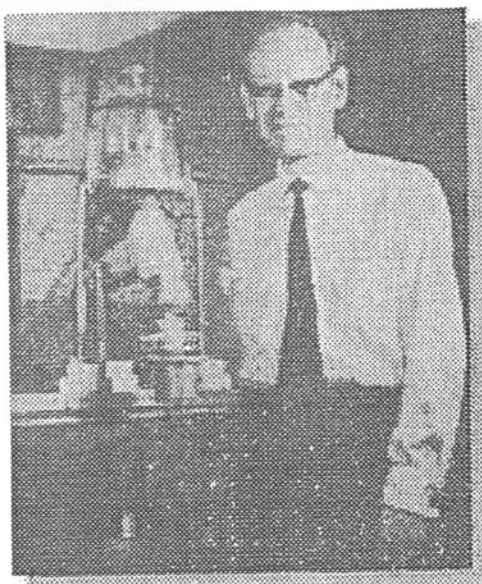

FIRST  
FUSION  
1960

## The Farnsworth Fusor

The Most Notably Forgotten Episode in "Hot" Fusion



YOUNG  
PHILO

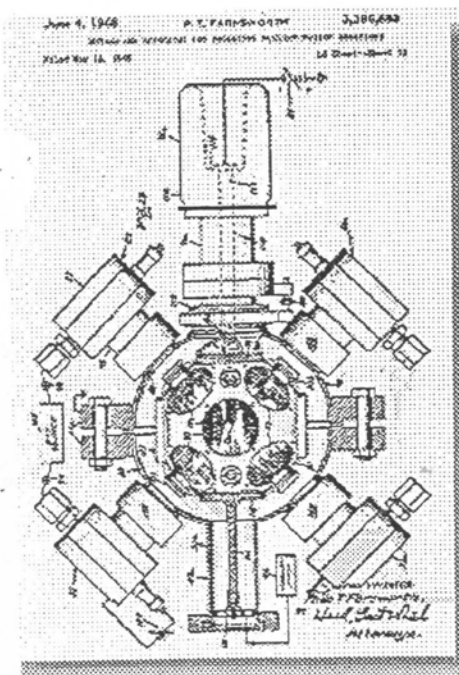

FINAL  
"FUSOR"  
1968

57



# DAILY NOTES

DATE Aug. 24, 1933,

TELEVISION LABORATORIES, (LTD.)

SUBJECT Electron Multiplier Dissector <sup>with</sup> Pumping ENGINEER B. C. Gardner

This tube was built and tested, but would not oscillate, therefore no multiplication.

FARNSWORTH  
IMAGE (T.V.)  
TUBE

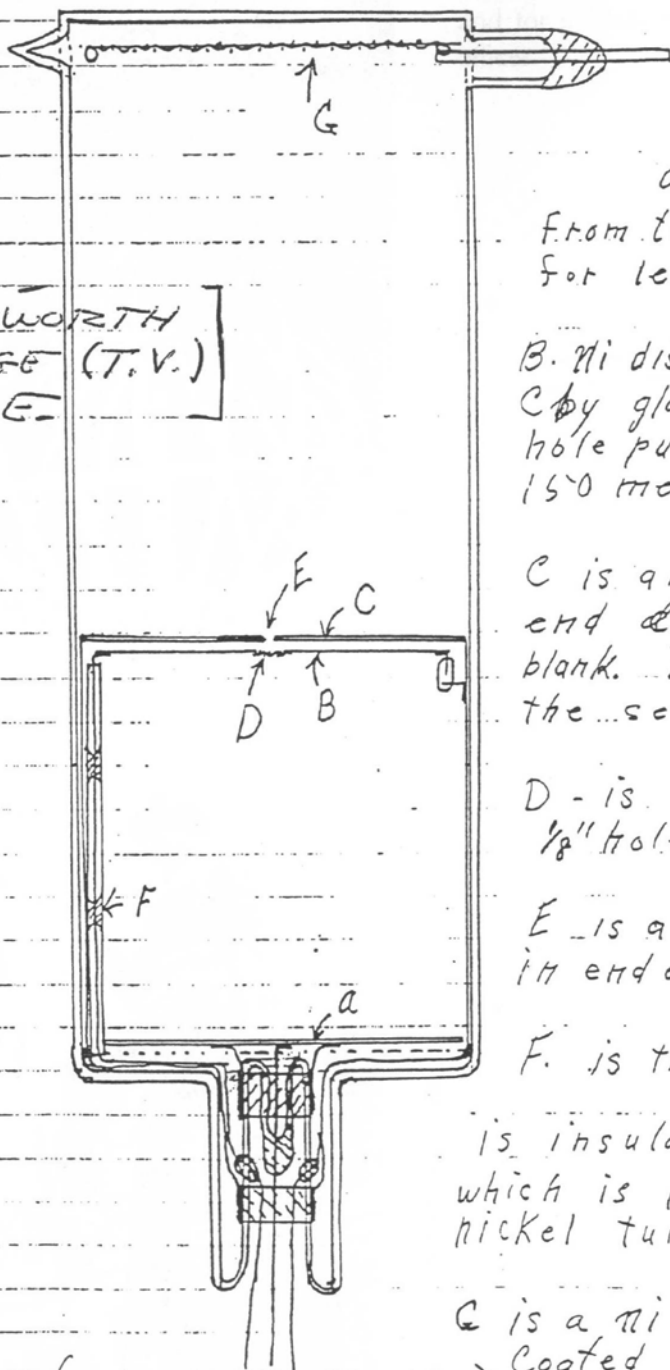

a - Nickel Disc supported from top collar on stem. With cutout for lead F thus

B. Ni disc supported from Shield C by glass beads, and having  $\frac{1}{8}$ " hole punched in center with 150 mesh screen welded across

C is a nickel cylinder with one end closed fitting snugly in glass blank. This unit is supported from the second collar on stem.

D - is 150 mesh screen over  $\frac{1}{8}$ " hole.

E is a .030" square aperture in end of can C.

F. is the lead to disc B and is insulated by  $\frac{1}{8}$ " glass tubing which is in turn enclosed in a nickel tube for shielding.

G is a Ni screen 150 mesh Coated with Sodium used as a photoelectric surface.

(Approx  $\frac{1}{2}$  Full size.)

STRONG FAMILY ARCHIVES

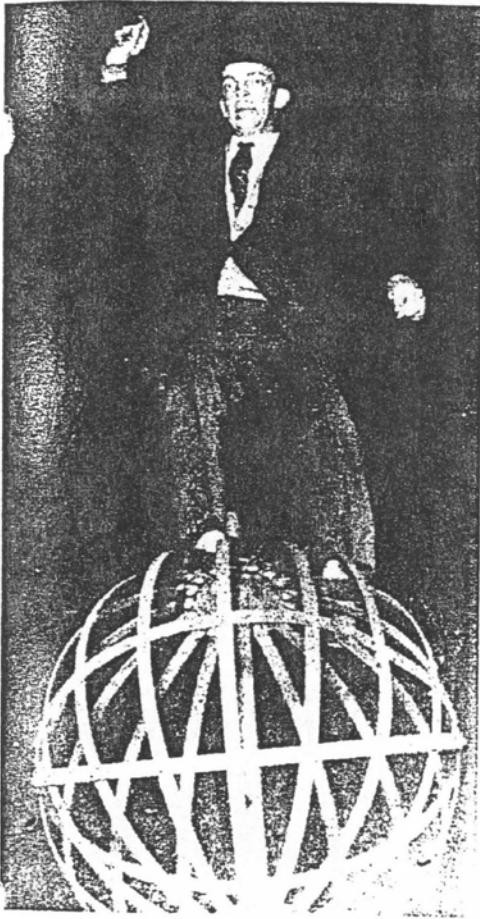

"Armstrong, why do you do these damnfool things?" In 1923 Armstrong's fondness for heights led him to pose for a series of day and night photographs at the top of the RCA broadcasting tower, 400 feet above 42nd Street. Sarnoff was not amused at the stunt and for a while banned him from the RCA offices.

ARMSTRONG  
HILY ARCHIVES



ARMSTRONG FAMILY ARCHIVES

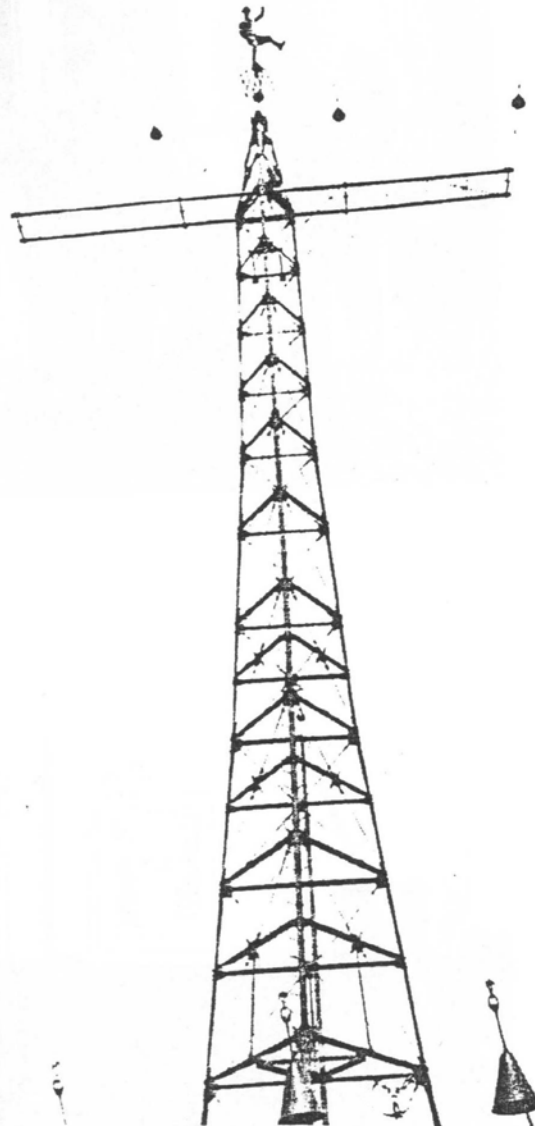



Armstrong with Marconi by wireless shed.

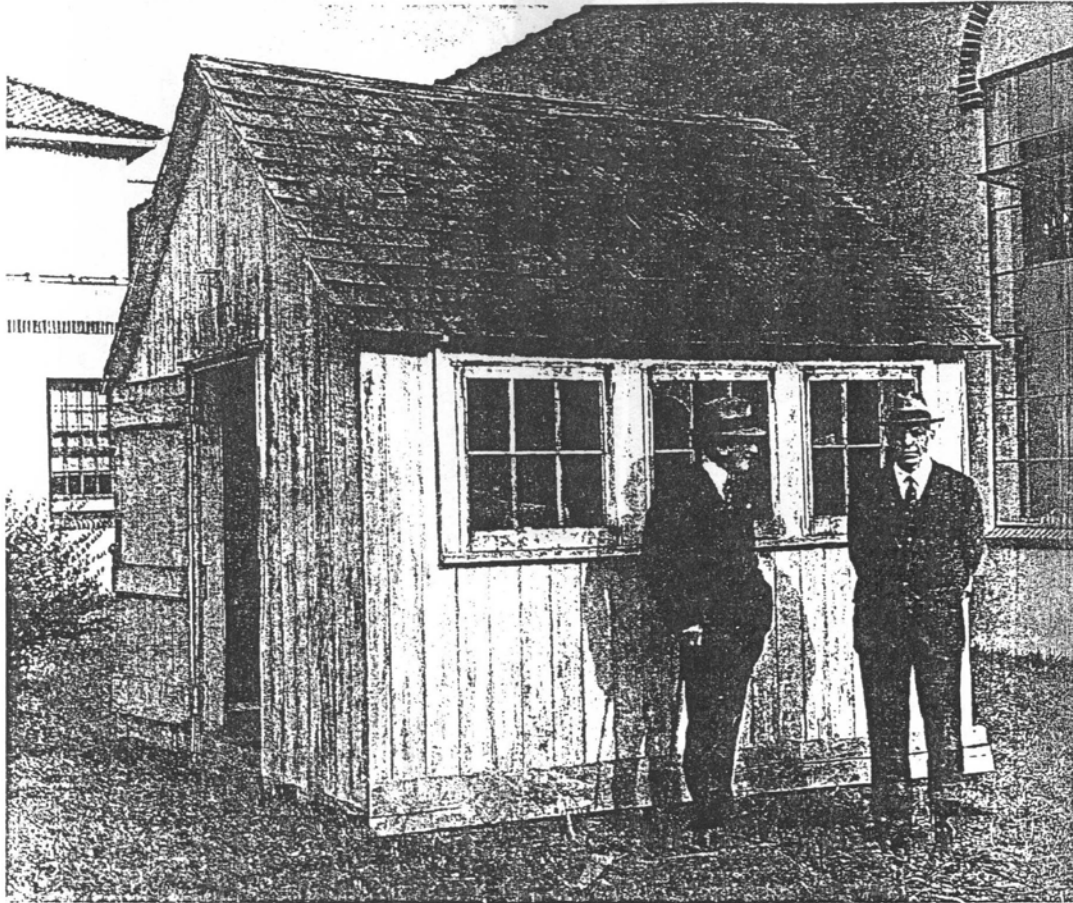

ARMSTRONG & HIS  
F.M. RADIO SET





Armstrong testifying at one of the numerous government hearings about FM.



Howard and Marion Armstrong in the last known photograph of the couple.

Headline from the front page of the *New York Herald Tribune*, February 2, 1954.

Inventor of FM

**Armstrong Writes Note To Wife, Dies in Plunge**

Maj. Edwin H. Armstrong, sixty-three, inventor of frequency modulation (FM) and one of the nation's leading radio pioneers, plunged to death yesterday from his thirteenth-floor apartment at River House, 435 E. 52d St.

Maj. Armstrong was found, fully clothed to overcoat, hat and gloves, on a third-floor extension at 10:30 a. m. by Alfred Henrichs, building maintenance man. He had apparently been dead several hours.

Police found a two-page note to his wife, Mrs. Marion Armstrong, signed "Ed," in which he said it was "heartbreaking" that he could not see her again and continued: "How deep and bitterly I regret what has happened to us."

The note, written in pencil on yellow legal paper, said he would give his life to be able to turn back to the time "when we were so happy and free" and ended:



Maj. Armstrong

Columbia University and the winner of a score of awards in-



"I DID NOT KILL ARMSTRONG!"



## **Chapter Four**

### **Dr. Alexanderson**

Author Commentary: pages 132 - 137

Historic Documents: pages 138 - 151

#### IV) ALEXANDERSON

1) Ernst Frederik Werner Alexanderson was born at Upsala, Sweden on the 25<sup>th</sup> of January, 1878. Alexanderson began his interest in electricity at an early age. In 1896, at age 18, he entered the Lund University for a year of study. Thereafter Alexanderson was to begin a three-year graduate program with the Royal Institute of Technology at Stockholm, graduating with degrees in electrical and mechanical engineering. Alexanderson thereupon entered the 20<sup>th</sup> century to lead a remarkably productive 75-year career as a developmental electrical engineer. His system of wireless is still known today by his name. His productiveness was no doubt due to his mentor, the wizard of Schenectady. Alexanderson was to become president of the American Institute of Electrical Engineers in 1944, at age 60, whereupon he received the award of highest distinction in electrical engineering, the Edison Medal. He was also to receive the Cedergergen Medal, first awarded to his mentor in 1917, 27 years beforehand. Some of Alexanderson's most significant developments are as follows.

a) The magnetron: A cyclotronic vacuum diode, utilizing thermionic emission. This invention led to the "tube that won the war," referring to the Magnetron Power Oscillator of WWII radar sets. This device was also the origin of the cyclotron particle accelerator of Lawrence. Alexanderson developed the Magnetron as an electronic amplifier with utilized no grid structure as a control element. The grid had patent protection with Lee De-Forest and his assignee, A.T.T. Alexanderson's Magnetron avoided the patent infringement and thus it was developed through his assignee, G.E. It was later found that the Magnetron could produce very powerful electric oscillations at billions of cycles per second. Thus it is used for radar, even until today.

b) The magnetic amplifier: A magnetic reactance, utilizing magnetic saturation as a control element. The magnetic amplifier, or Magamp, has the ability to regulate the flow of power with no generators and without the use of expensive and short-lived grid controlled rectifiers. It requires absolutely no attention. The Magamp is capable of regulating hundreds of kilowatts quickly and precisely. It was to become the heart of most industrial control systems before the Silicon Gate Controlled Rectifier, or S.C.R. It is still widely used today.

c) The Alexanderson multiple tuned antenna: A large waveguide structure for low radio frequencies, utilizing longitudinal as well as transverse loading elements. This structure, a key element in the Alexanderson system of wireless, allowed for the transmission of very long wavelengths with a comparatively small aerial. It could be called an antenna with no wavelength. The Alexanderson antenna eliminated the large parasitic power flow found in the Marconi designs. This structure



represents one of very few significant wireless developments since Tesla. The Alexanderson aerial finds no application today, but still may prove to be an important concept for future developments.

Alexanderson's developments are still worthy of further study today from the standpoint of theoretical electrical engineering, the generalized theory of these being still unknown. Like the outcome of the Magnatron, the Magamp Power Oscillator could produce amazing results. The Alexanderson aerial still has some remarkable possibilities in non-electromagnetic transmission. Dr. Alexanderson was to hold 322 patents in all, from railway motors to electron tubes. During his 48-year career with G.E., he was to produce one patent every 11 months for his assignee. His last inventions were in television. It is hoped that his writings on electrical engineering can be brought out for study, if they can be found. He is still not ready to retire.



**Figure 5.1.** Guglielmo Marconi (on left) and Alexanderson in May 1915, when Marconi visited Schenectady to observe a radio alternator in operation. Courtesy of Verner Alexanderson.

2) With the arrival of the 20<sup>th</sup> century, a book was published that would set the course of Alexanderson's life. In his studies he happened across *Theory and Calculation of Alternating Current Phenomena*, 1900, by Charles Proteus Steinmetz, the wizard of Schenectady. Steinmetz was, and still is, regarded as the foremost theoretical electrical engineer of the 20<sup>th</sup> century. His ability to take great problems in electrical engineering and solve them with "high school" Algebra, remains unparalleled. Steinmetz earned his fame with the publication of this book and the great understanding it gave its readers. A.C. was a mystery no more. It was said that here G.E. gave Steinmetz permission to create electricity from the square root of minus one. Upon reading this book, some 400 pages of operational calculus and vector diagrams, with a few words in English now and then, Alexanderson promptly immigrated to Schenectady, New York, to gain the opportunity to work with the great Steinmetz. Alexanderson arrived at General Electric Schenectady to meet their wizard in 1901. By 1902 Steinmetz located him a drafting position with G.E. It was a job of drudgery for young Alexanderson, age 26, but at least he was part of the Schenectady facility, the home of the wizard.



ALEXANDERSON  
AGE 26  
AT G.E.



3) In 1904 Alexanderson was to be given his first major engineering task, one which would earn him his fame. G.E. was asked by the National Electric Signaling Company, N.E.S.C.O., of Reginald A. Fessenden, to produce an alternator with 200,000 alternations per second, an unheard of speed for G.E. The machines they produced normally operated no more than a few hundred alternations, 25, 60 and 133½ being the typical for that time. In addition such high frequency devices had already been developed by Nikola Tesla and were under his patents. Alexanderson was handed a most difficult assignment: make this alternator. By 1906, at age 28, he had developed his first high frequency variable reluctance alternator, to be known as the Alexanderson alternator. He now held his first six patents with G.E. A 2 kilowatt, 100 kilocycle/second machine was delivered to the Brant Rock, Mass. station of N.E.S.C.O. on Christmas eve, 1906. Redinal Fessenden transmitted the first musical radio broadcast: himself, singing and playing the violin. Shipboard operators listened in absolute amazement as the faint sounds of the violin drifted in among the crackles of static and buzzings of the spark stations.

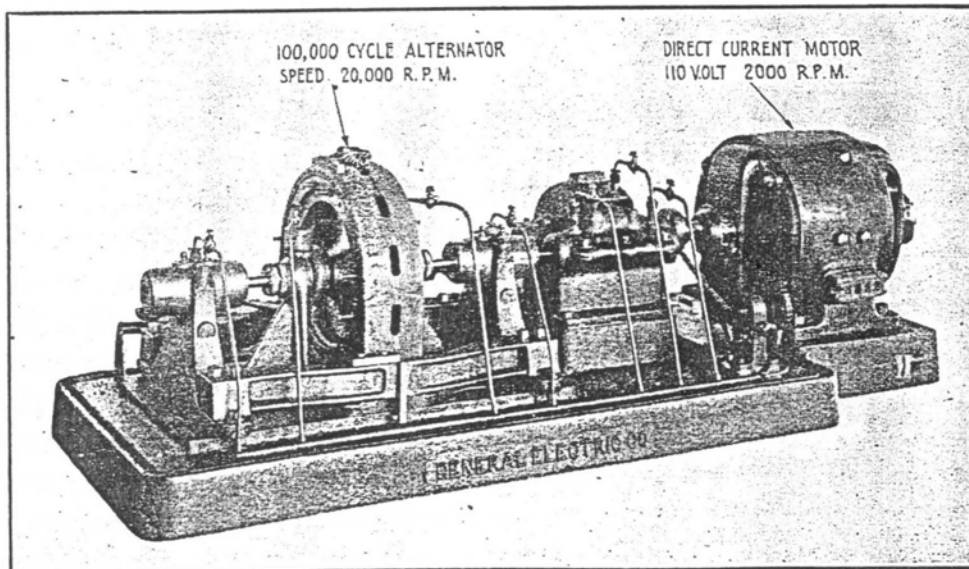

Fig. 280a—The 2 K. W. 100,000 Cycle Alexanderson Alternator.

*THE FIRST SET FOR  
FESSENDEN & N.E.S.C.O.*

4) By the year 1910, at the age of 32, Alexanderson joined Steinmetz in the formation of the consulting engineering department at G.E. Schenectady. Things had come a long way since Elihu Thompson. Steinmetz was undertaking his next book, *Theory and Calculation of Transient Electric Phenomena*, dealing with the most complex engineering problems of the day: switching surges and the wireless. Here Steinmetz would develop the engineering formulae for electrostatic and electromagnetic wireless, which Alexanderson would have at his disposal. Alexanderson engaged in a very prolific interval of electrical and wireless developments while with Steinmetz and their department. Here he was to fully develop his alternator into giants of 200 kilowatt capacity. He would also develop his famous wireless aerial and his Magamp Keyer to go with the alternator to form his system for the transmission of wireless telegraph impulses. This was the Alexanderson system and was the reason for the creation of the Radio Corporation of America. Marconi traveled to G.E. Schenectady to examine the Alexanderson system for himself. He was so impressed with its quiet and stable operation that the disruptive discharge (spark) equipment recently installed at his New Brunswick facility was removed in 1915, and a 50 kilowatt Alexanderson system was installed in its place. Marconi was eager to obtain the 200 kilowatt units for both New Brunswick and Bolinas, but he was to receive no more of the Alexanderson equipment.

5) After the urging of Assistant Naval Secretary Franklin Roosevelt, President Wilson asked G.E. to suspend any further sales to Marconi. Alexanderson's system was not to be in foreign hands. After the U.S. Navy takeover of American Marconi in 1917, a 200 kilowatt Alexanderson system was installed at New Brunswick. By 1919 plans were underway to install similar units at Bolinas. The system at New Brunswick, N.J. was used by President Wilson to effect the end of the great war through the broadcast of his ultimatum to Germany and the radio telephone contact it offered him while at Versailles. When the Radio Corporation of America was formed to take control of the Marconi New Brunswick series of stations, Alexanderson was shifted to R.C.A. from G.E. to become R.C.A.'s new chief engineer at age 42. Alexanderson would begin the implementation of his system upon that of Marconi at Bolinas, and design the greatest wireless undertaking in history: R.C.A. Radio Central at Rocky Point, New York. Radio Central was to be a massive facility with a four-square mile aerial structure and 12 200 kilowatt alternators. This major engineering undertaking was never to be fully realized, becoming obsolete after the appearance of shortwave. The Bolinas facility was to see the full embodiment of the Alexanderson patent, an aerial with no wavelength, because of the site's restricted space. After shortwave, Alexanderson would develop a few shortwave dipole arrays, but left R.C.A. in 1924, his system being obsolete.



6) Leaving R.C.A., Alexanderson would return to Schenectady. But 1924 also brought the very untimely death of Steinmetz, age 59, his work unfinished. Four years after his return, Alexanderson would be appointed head of the consulting engineering department. At the age of 50 he would take the position of his mentor. His department would go through many name changes throughout the years, and see L.V. Bewely pick up where Steinmetz left off. Bewely's book, "Traveling Waves On Transmission Systems," stood well against the work of Steinmetz. Alexanderson was to remain with G.E. officially until his retirement in 1948, at age 70. G.E. had a tough time getting him to leave and he stayed another year. Alexanderson was not a person to retire, so he began a new career.

7) At the end of his engineering position with R.C.A., Alexanderson was to send the first radio-photographs across the Atlantic. In 1924, radio facsimile was born. This was to begin Alexanderson's work in picture-radio, now called television. The systems of the time were complex rotating machines, well suited for Alexanderson's background in electro-mechanical engineering. This became known as the rotating disk method of picture transmission, and was similar to the new moving picture projector of Edison. Alexanderson transmitted his first picture-radio signal from his own home on Jan. 13, 1928. Later, a 7-foot screen was fabricated at G.E. and installed in a local theater. On May 22, 1930, the theater orchestra was led by the image of their conductor on the screen, his being at the G.E. plant one mile away. However, the television was to be an electronic affair, Zworykin reworking Farnsworth's image dissector into the R.C.A. iconoscope. No application was found for the spinning disk, and it was dropped. His radio-facsimile was a great success however, and is used today. Alexanderson, being unable to retire, re-joined R.C.A. as a consulting engineer in 1952. His 321<sup>st</sup> invention was a color television receiver for R.C.A. in 1955. He was 77 years old.

8) Alexanderson was productive through his late years, never willing to retire. He was to involve himself in semiconductor power control, the replacement for his Magamp, and modern ultra high voltage D.C. power transmission. His work was to span the years of the spark gap to the years of the transistor, a most remarkable career in electrical engineering. He was to receive 28 more patents after leaving ~~General Electric~~ RCA General Electric. At the age of 97, in 1975, Alexanderson died where his career began, Schenectady, home of the wizard. In his work there still is a faint glimmer of electricity from the square root of minus one.

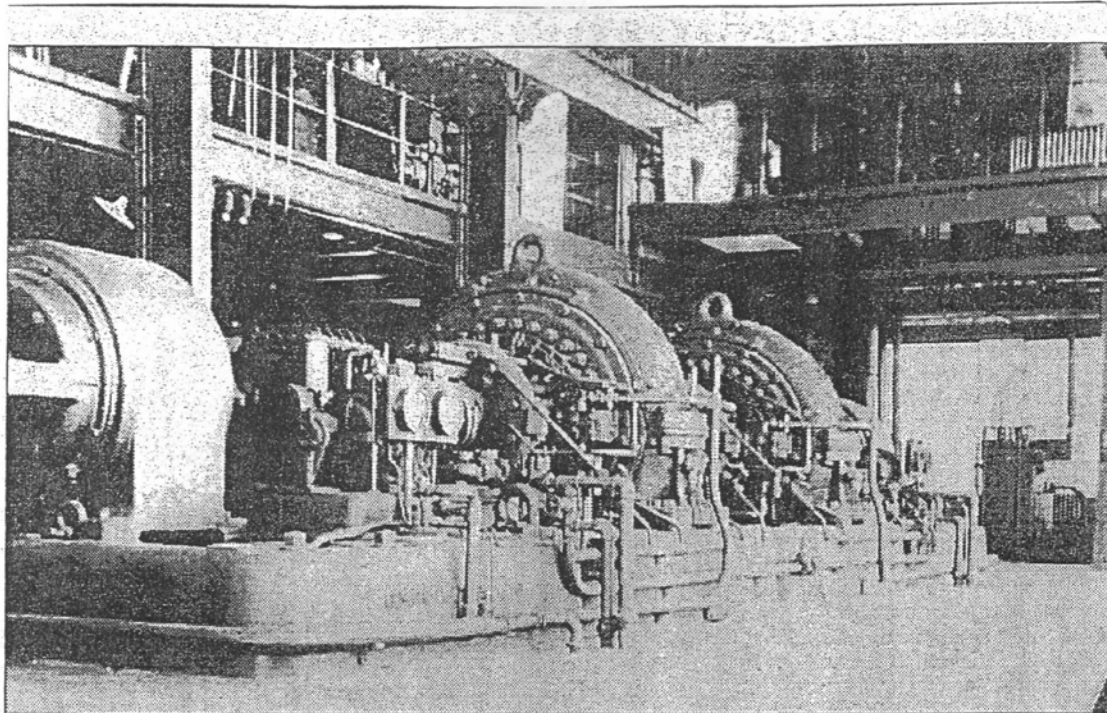

THE FULLY DEVELOPED  
ALTERNATOR AT HAWAII

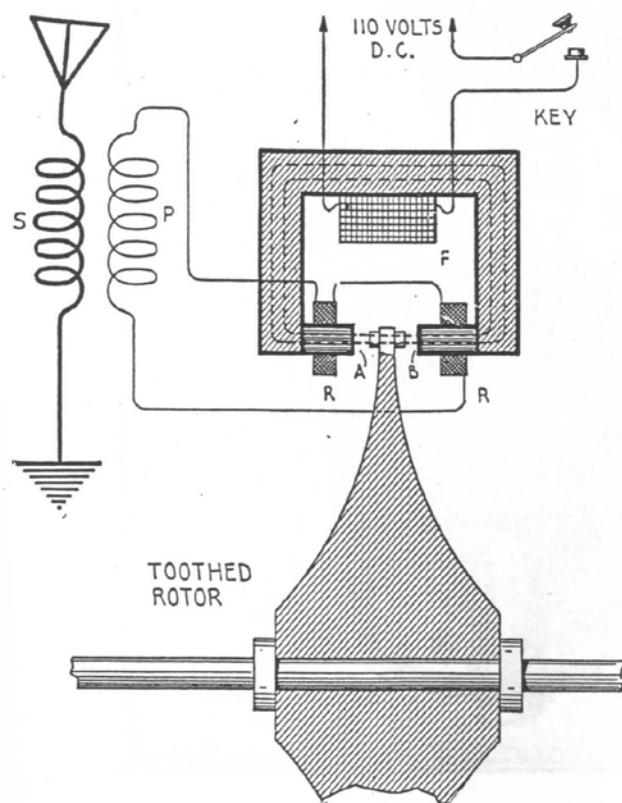

Fig. 280—Details and Connections of the Alexanderson Radio Frequency Alternator.

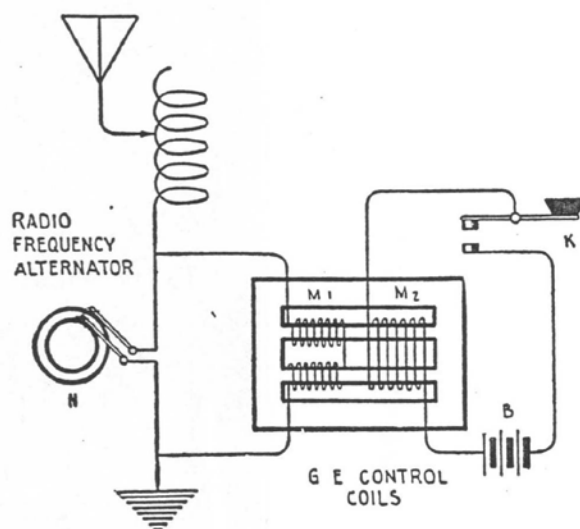

Fig. 281—Showing the Fundamental Circuit of a Radio-Frequency Control Device Developed by the General Electric Company.



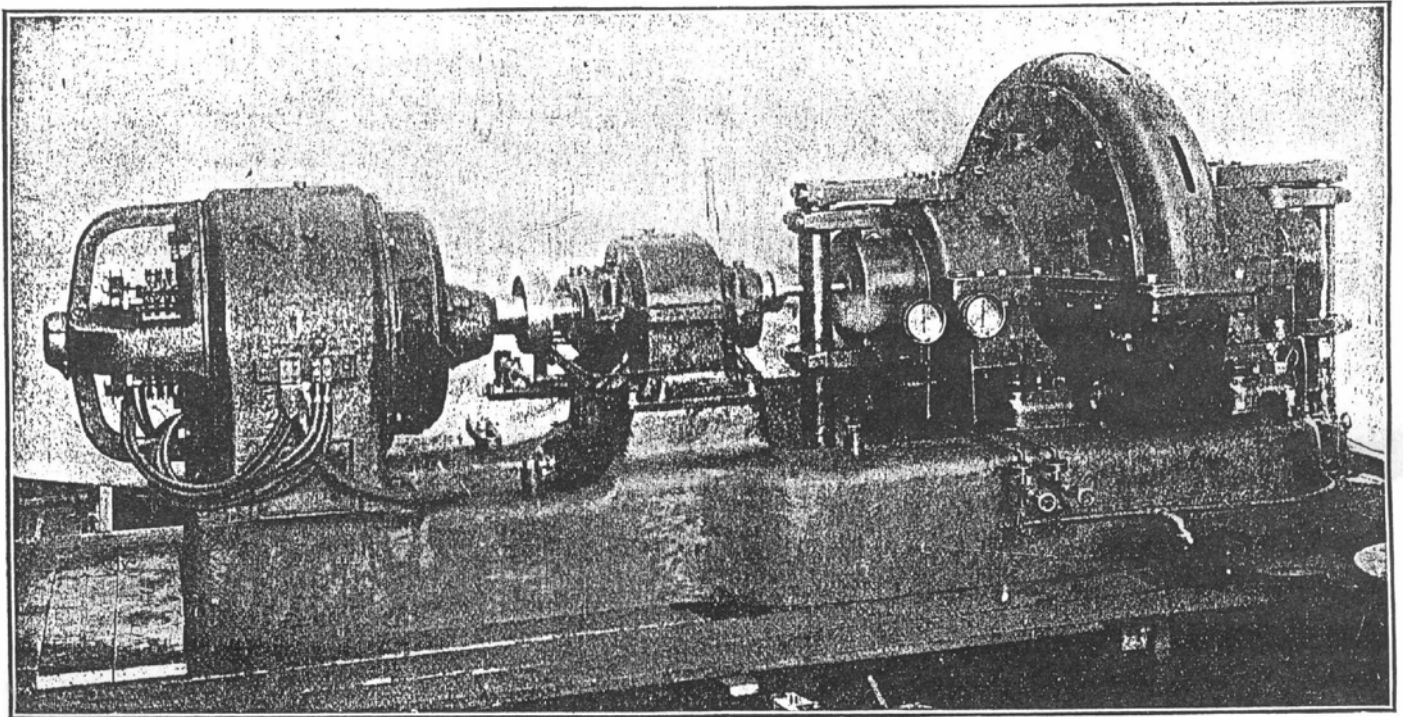

Fig. 282—The 75 K. W. 50,000 Cycle Alexanderson Alternator.

MARCONI'S FIRST NEWBRUNSWICK SET



FIG 24

ERNST F. W. ALEXANDERSON

# THE WIRELESS WORLD

THE OFFICIAL ORGAN OF THE WIRELESS SOCIETY OF LONDON

Vol. IX. No. 50.

FEBRUARY 18TH, 1922

FORTNIGHTLY

FIG  
25

New York Radio Central

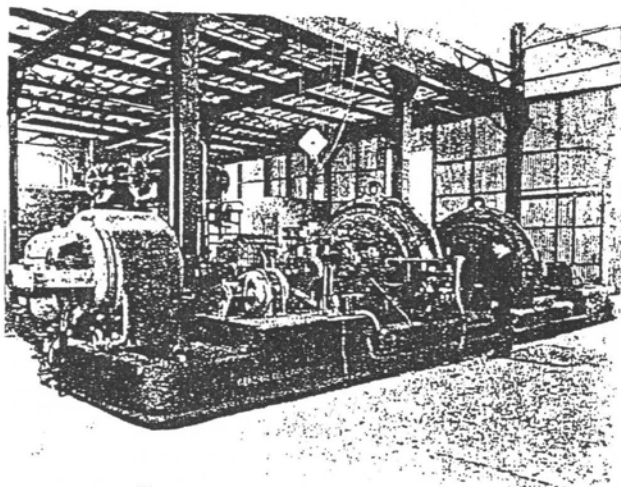

Fig. 4 Two of the 200 kW. Alternators.



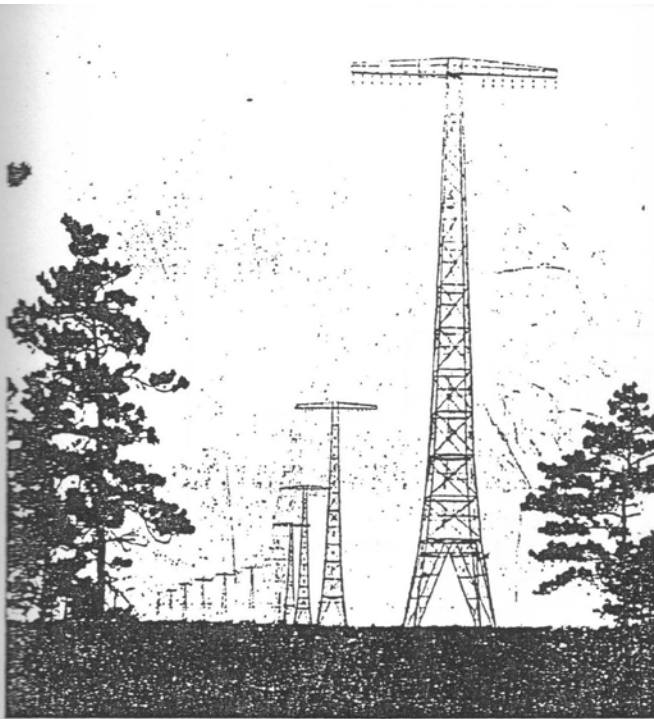

Fig. 3. The first twelve Towers of the Aerial System.

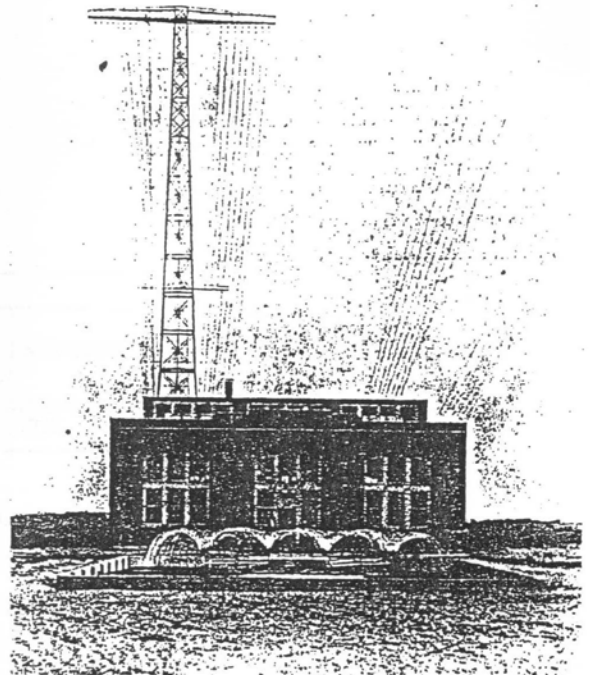
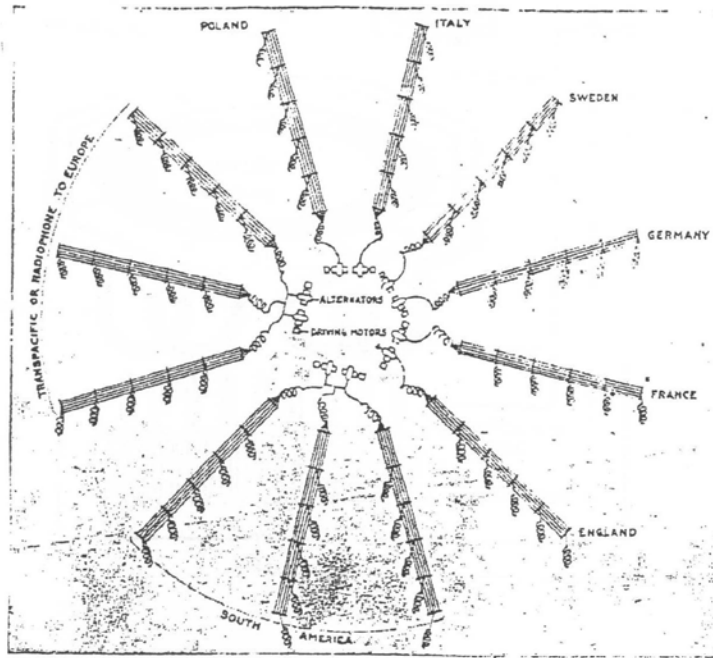

Fig. 2. View of the Power House showing the Cooling Pond in foreground.

FIG 25



Radio Corporation of America

A LONG WAVE ANTENNA SYSTEM

How the powerful high frequency alternators are connected to the multiple-tuned antennas at Radio Central. Most of the antenna systems are pointed in the opposite direction from the country with which they communicate.

Antenna Diagram of Alcoa

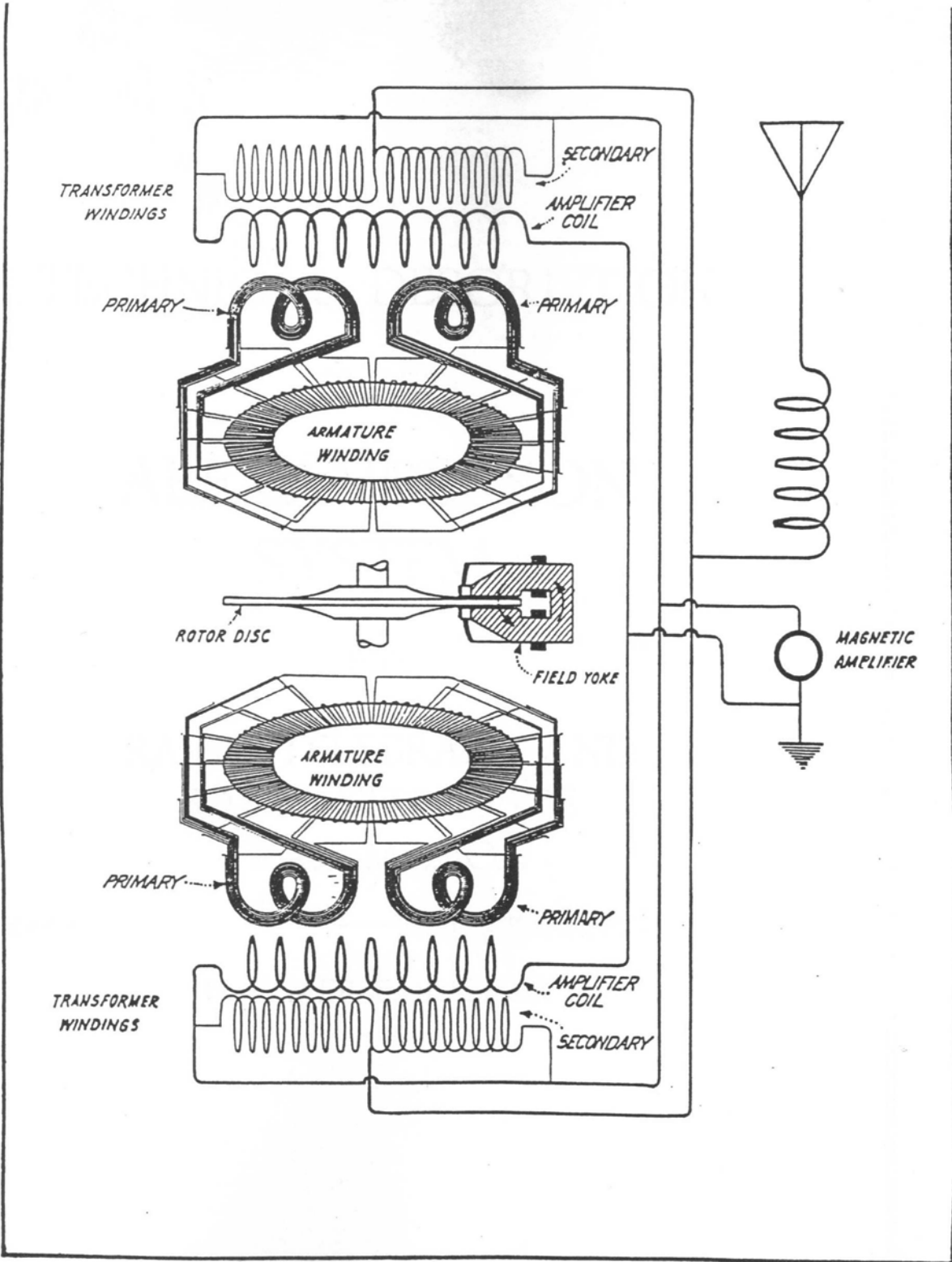

FIG. 5.  
Schematic Diagram of Alexanderson Radio Frequency Alternator Circuits.



W50  
W79  
WCC  
W1M.

TECHNICAL DESCRIPTION

OF THE

ALEXANDERSON  
SYSTEM

FOR

RADIO TELEGRAPH AND  
RADIO TELEPHONE  
TRANSMISSION

---

By ELMER E. BUCHER

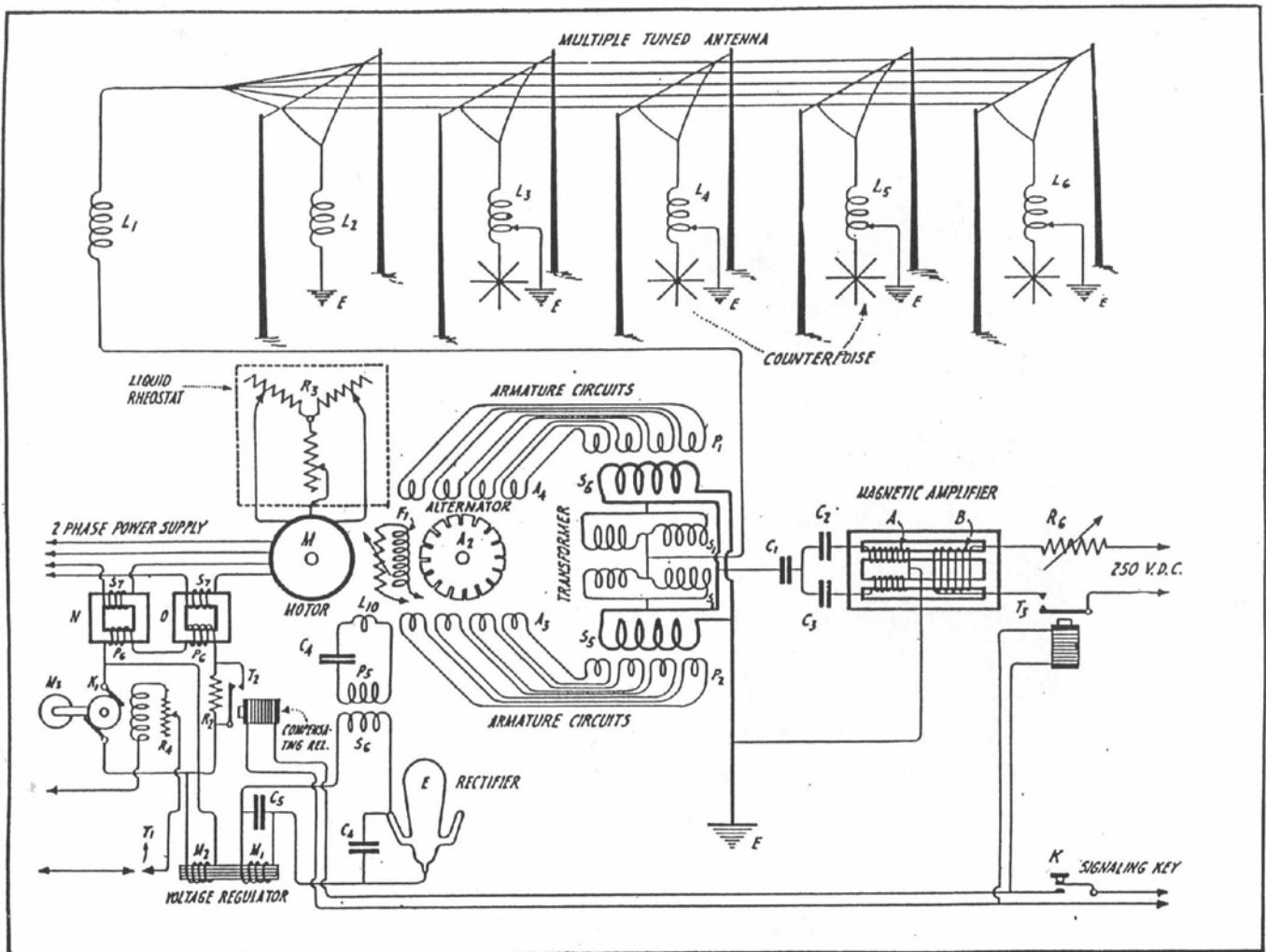

FIG. 10.  
 Fundamental Station Diagram of 200 Kilowatt Alexanderson Alternator Set,  
 Radio Corporation's Transoceanic Station, New Brunswick, N. J. (U. S. A.)



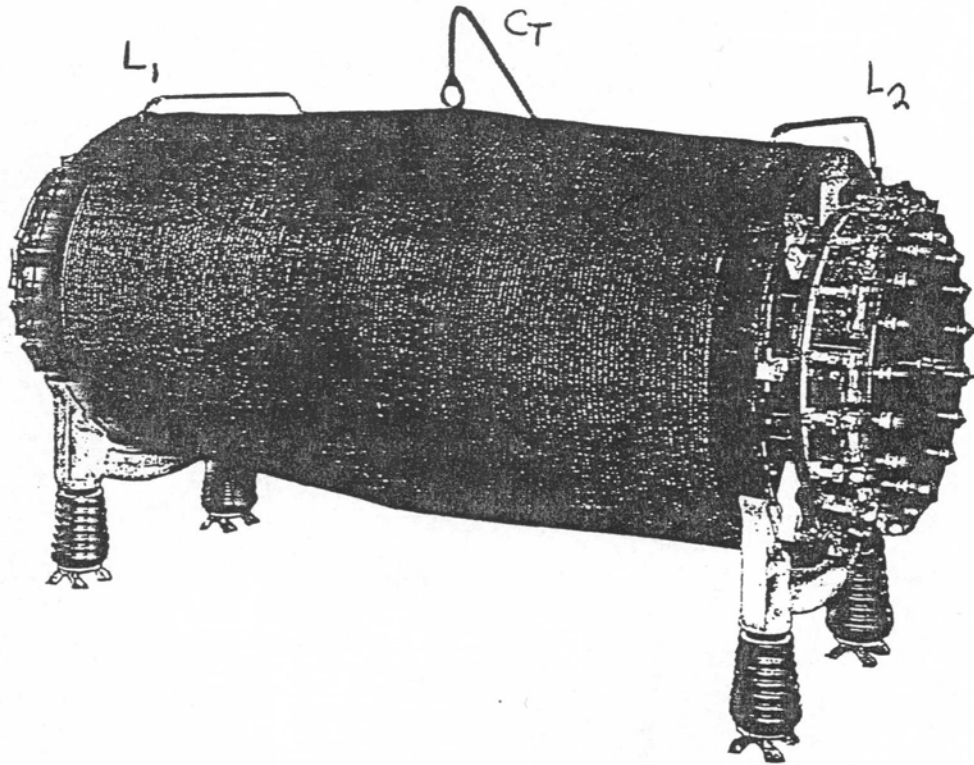

FIG. 13.  
High Frequency Transformer.

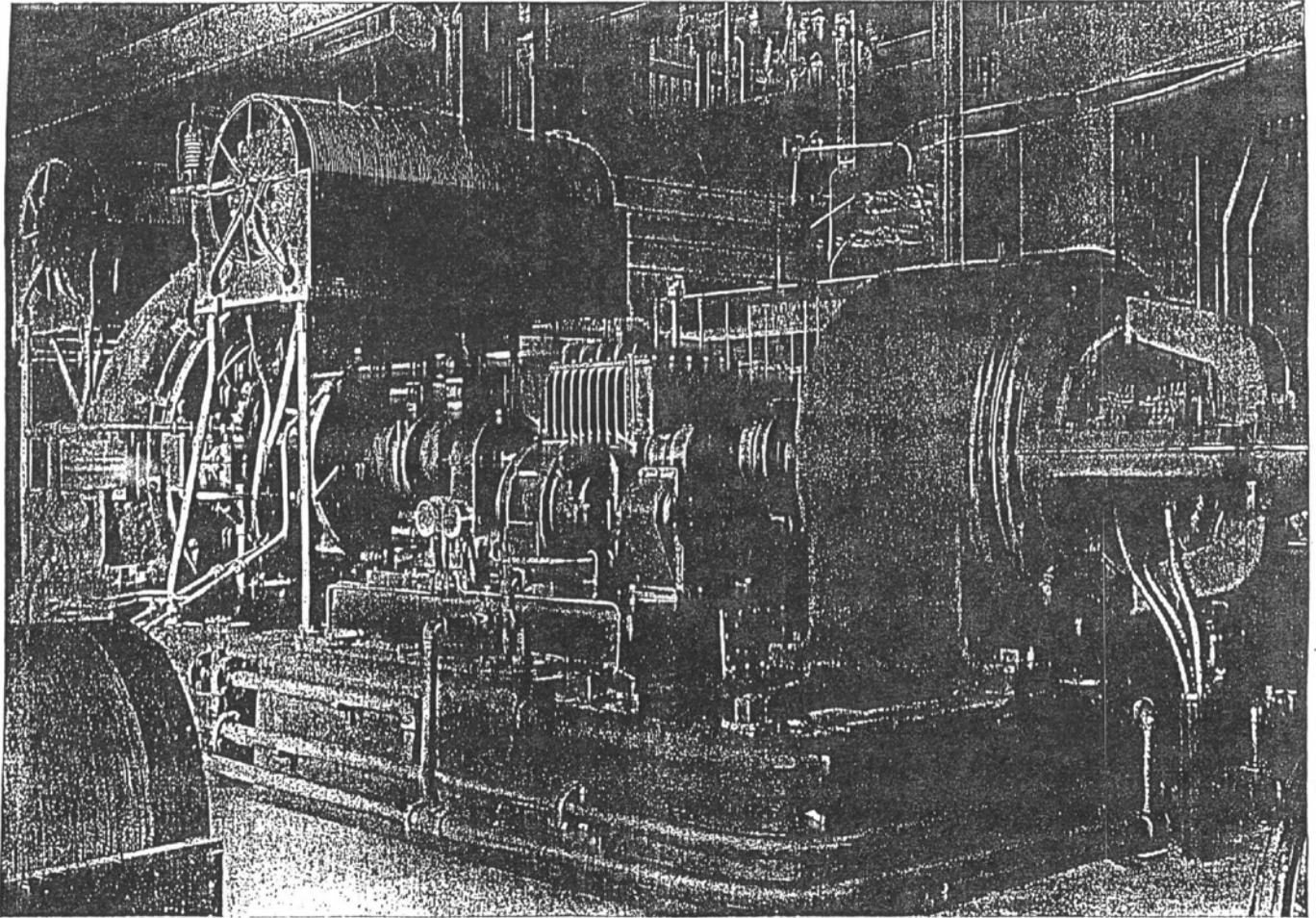

FIG. 2.

Motor End View of 200 Kilowatt Alexanderson Alternator.



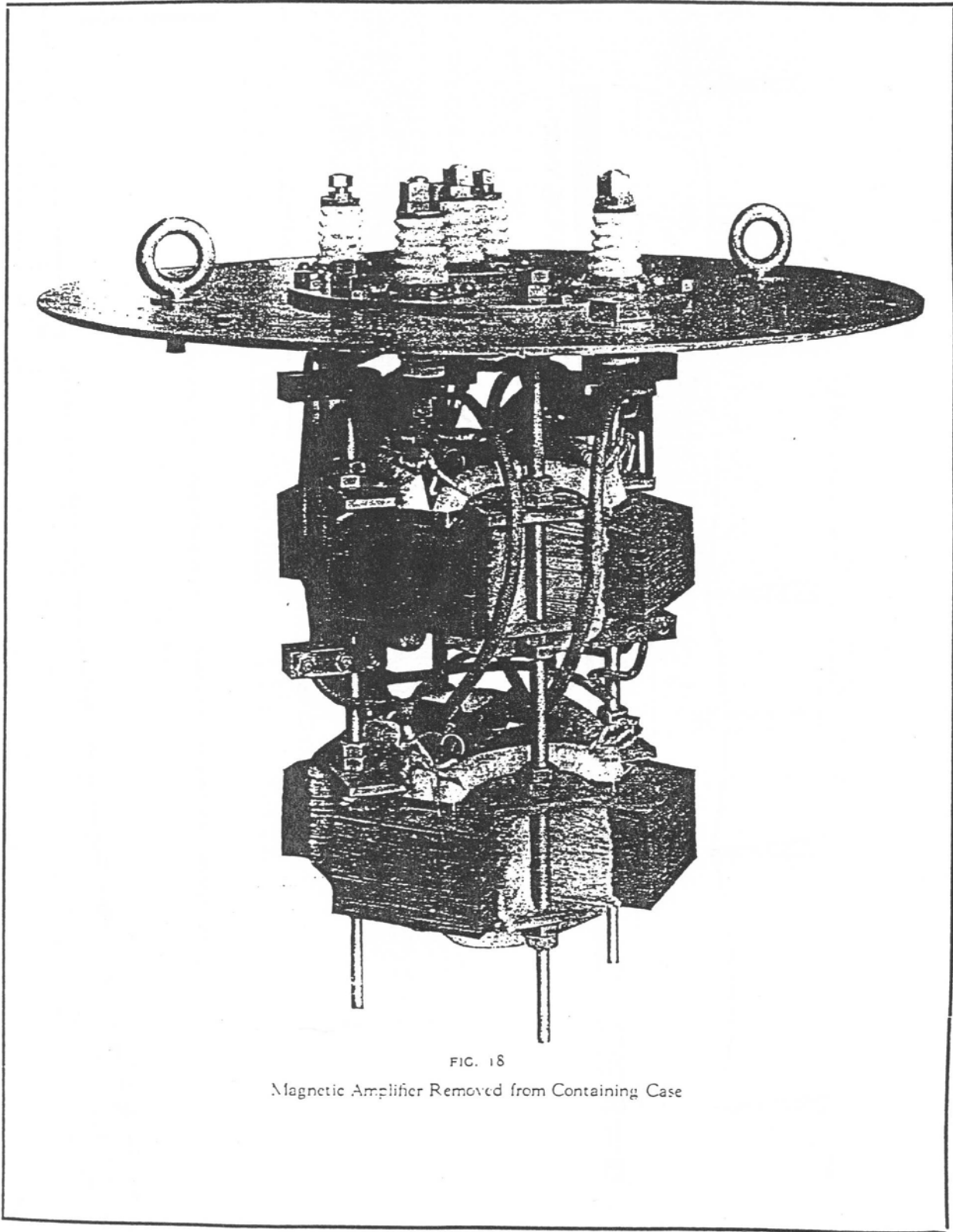

FIG. 18

Magnetic Amplifier Removed from Containing Case

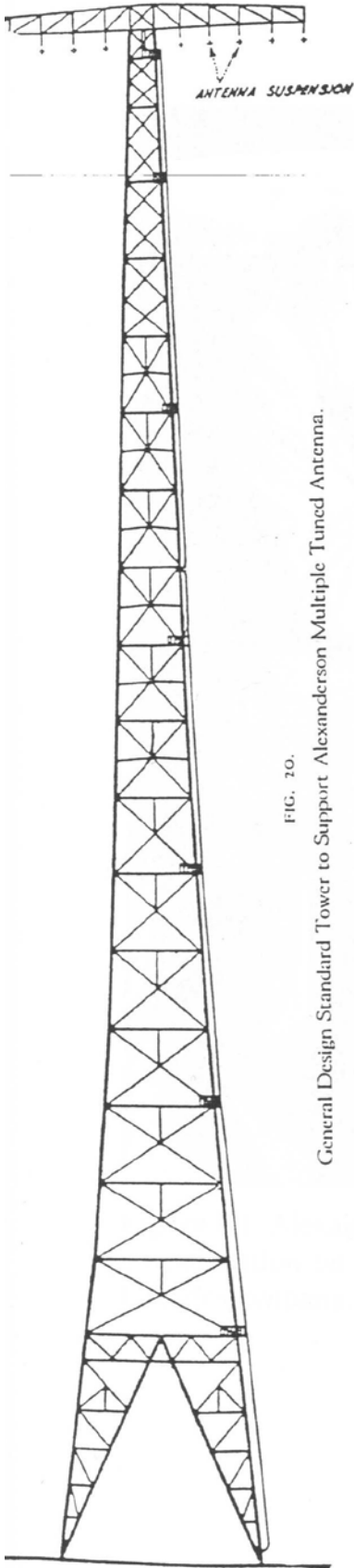
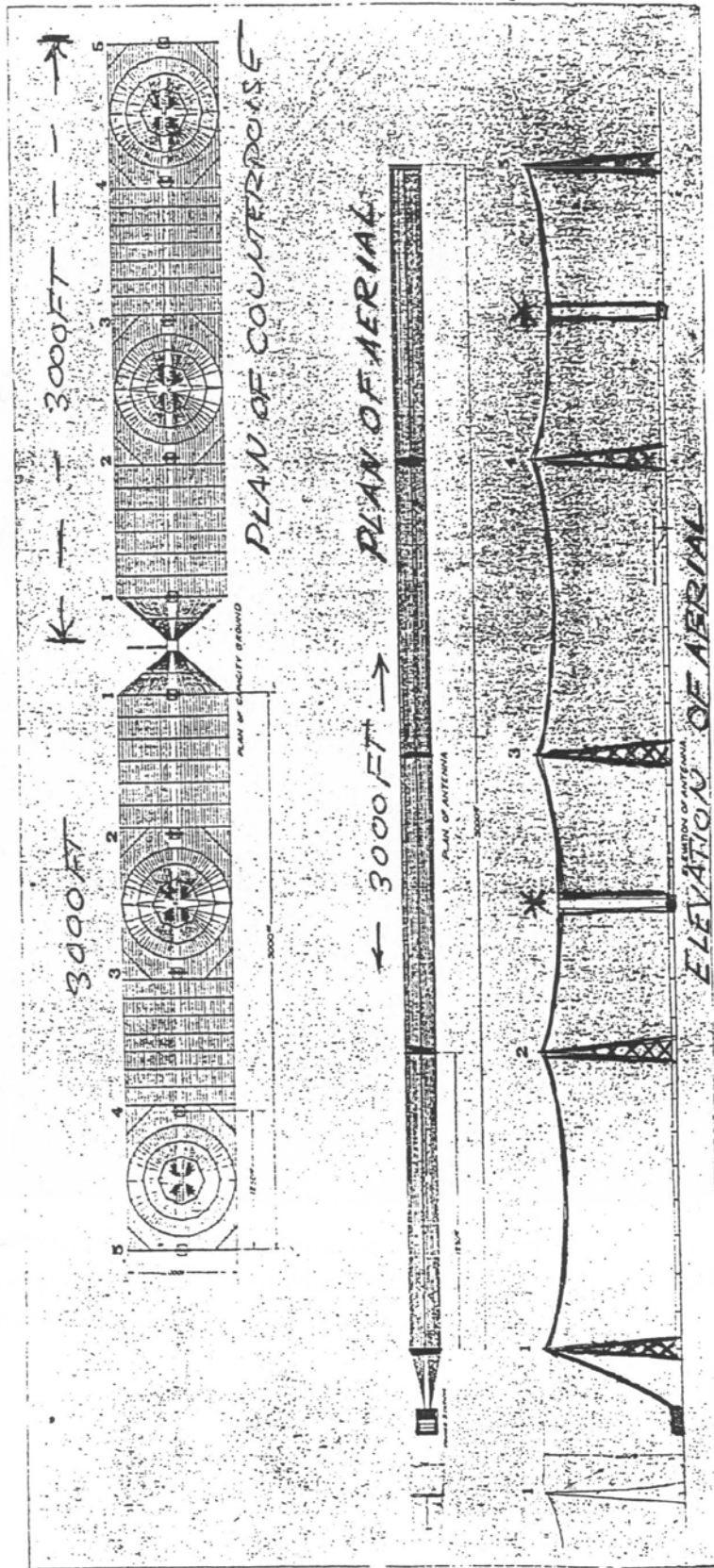

FIG. 20.  
General Design Standard Tower to Support Alexanderson Multiple Tuned Antenna.



\* DOWNLEADS  
TO COMPENSATOR

FIG. 21.  
Antenna Construction and Counterpoise for Typical 500 Kilowatt Alternator Installation.



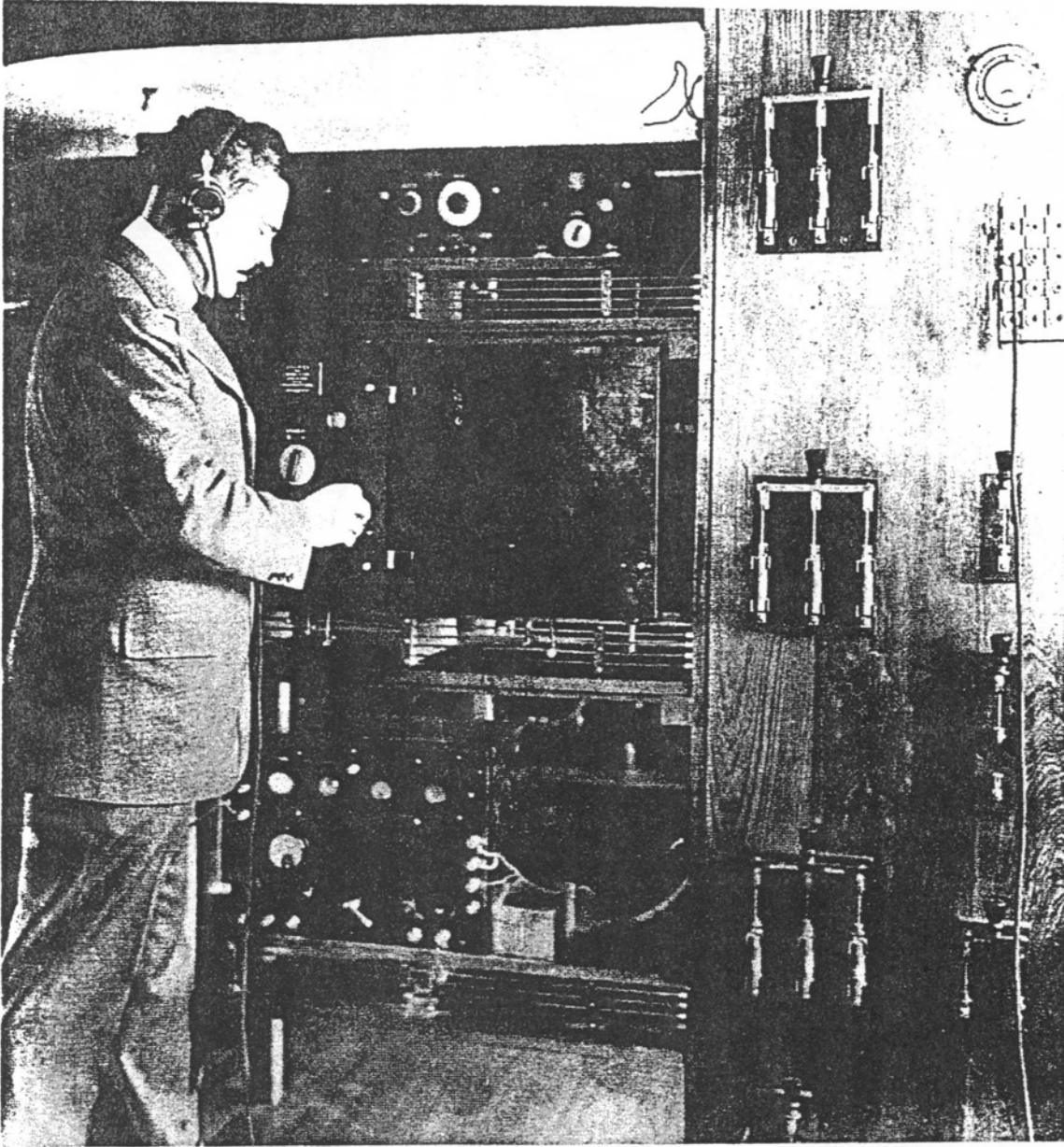

**Figure 6.1.** Alexanderson adjusting the transoceanic radio receiver at the Riverhead station on Long Island, N.Y., in May 1922. Courtesy of the General Electric Company, Schenectady, N.Y.



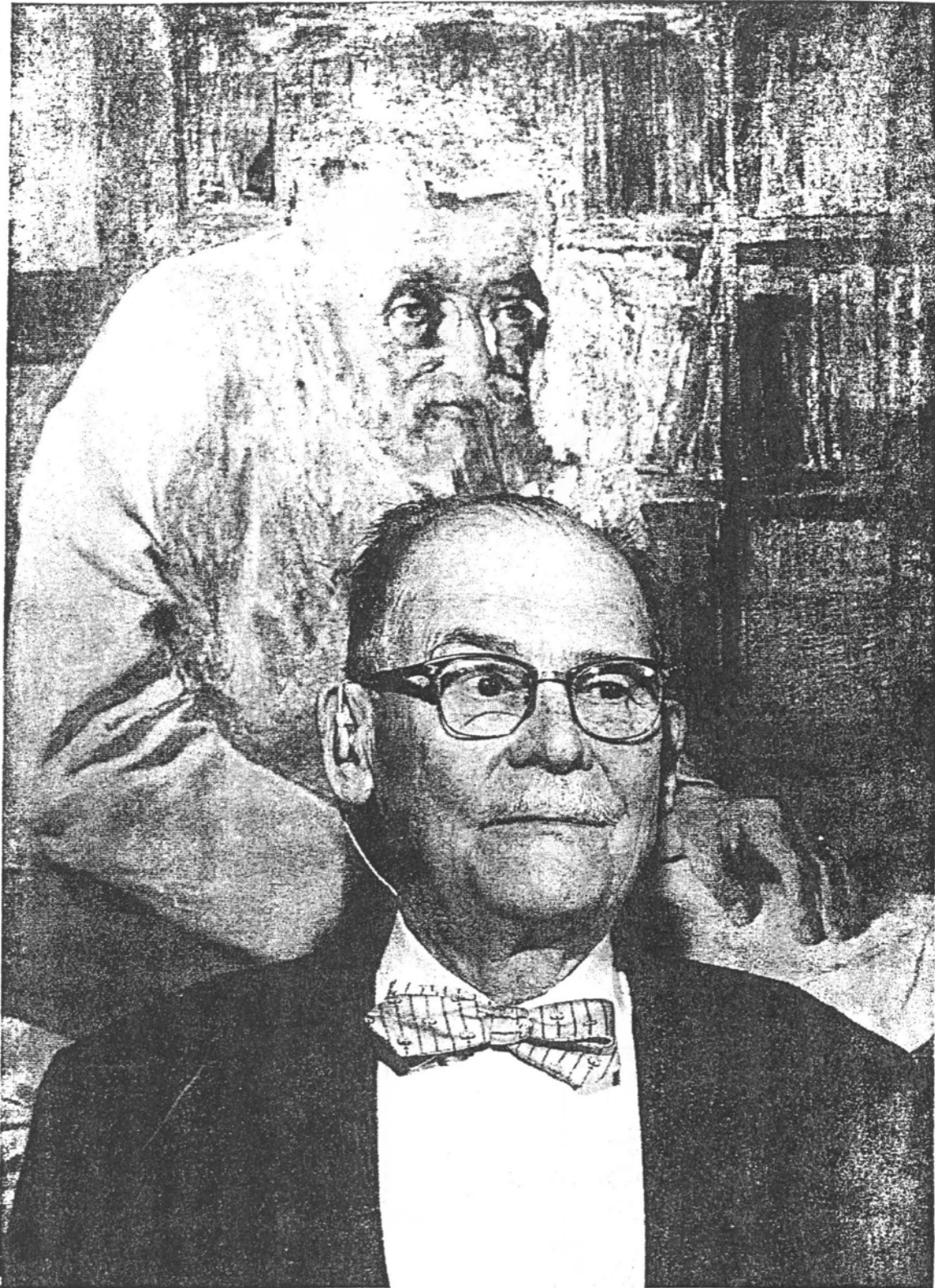

**Figure 10.2.** Alexanderson attending the Charles P. Steinmetz centennial luncheon in April 1965. Alexanderson is seated in front of a portrait of Steinmetz. Courtesy of the General Electric Company, Schenectady, N.Y.



1905, THE BIRTH OF ELECTRONICS

SOLID  
STATE

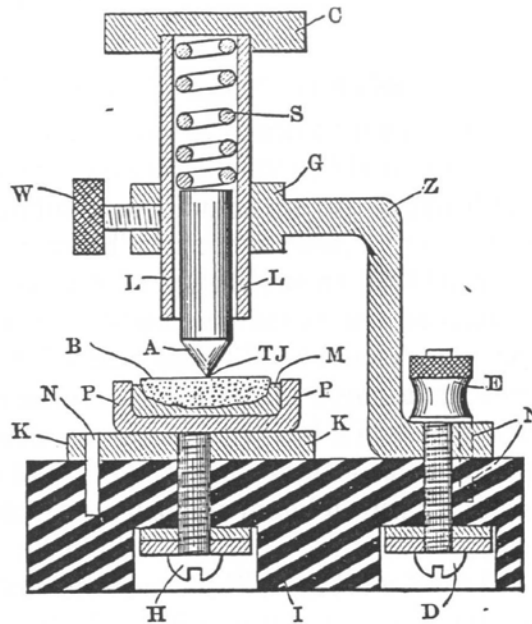

FIG. 113. Pickard's silicon detector.

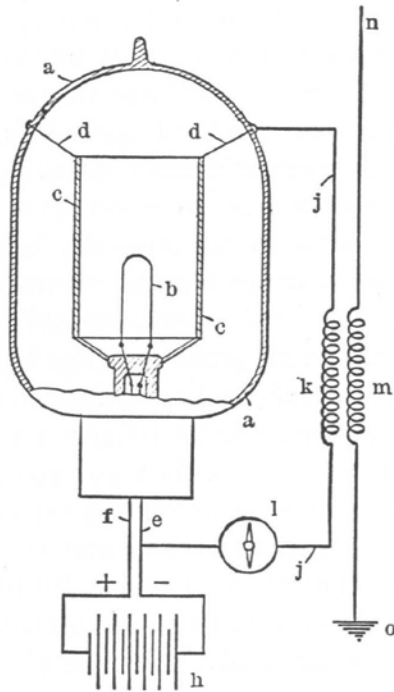

FIG. 140. Professor Fleming's vacuum tube rectifier.

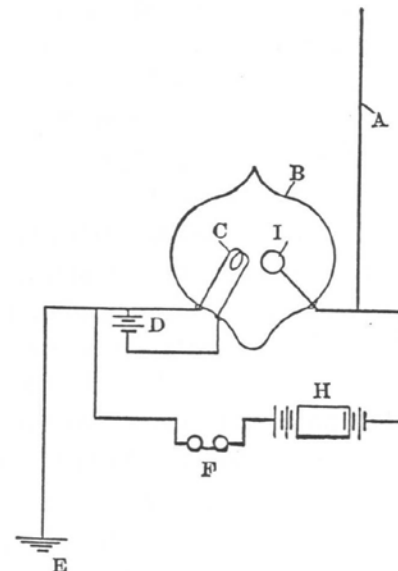

FIG. 141. Circuit employed by Dr. DeForest with vacuum detector.

RADIO TUBE

## **Chapter Five**

### **The San Francisco Bay Area**

Author Commentary: pages 153 - 156

Historic Documents: pages 157 - 166



## V) THE SAN FRANCISCO BAY AREA

1) Bolinas is situated within the county of Marin on the north coast of the San Francisco Bay area. For many years the county of Marin was predominantly dairy land with an active shipbuilding operation on the bay at Sausalito. Marin was also home to the strategic air command's Hamilton field, a storehouse of nuclear weapons. Also, the Army had a Nike Missile site on the Marin headlands. San Rafael served as the county seat. Marin was not an area of scientific or technological development. To the south of San Francisco are the counties of San Mateo and Santa Clara, in an area known as "the Peninsula." This was the home of major developments in electronic technology, and it hosts Stanford University. Today it is known the world over for its ultra-sophisticated billion-dollar electronics industry. It is forgotten that this found its origins in wireless.

2) Whereas Bolinas was "remote controlled" from New York City by the strong Marconi-Sarnoff archetype, the South Bay was host to a variety of small companies and the important federal arc, the alternator's competition. Stanford University and International Telephone and Telegraph would mold the history of this wireless scene. R.C.A. would expend much effort in blocking the work of the South Bay pioneers, but ultimately would be defeated, proving to be no match for the genius of the area. The principle difference between the New York electrical engineers and the San Francisco electronics groups was in their ethnic and educational makeup. The East Coast group were European immigrants that fled a crumbling Europe. Their education was from the universities of Europe, the teachings of the nature of the dominant culture. These individuals, by nature, were multi-lingual: Alexanderson from Sweden, Steinmetz from Germany, Marconi from Italy, etc. In contra-distinction, those in the Bay area group were mostly second- or third-generation Americans, educated at American universities. They spoke only English, meaning they were unable to read the journals of Europe. The European institutions and the electrical science they created were functions of the Victorian era, wherein a heavy emphasis existed on natural philosophy and a strong spiritual realm always co-existed with the physical undertakings. On the West Coast the institutions were more in the form of technical schools, and spiritual considerations were thought to have no place in science. The mind state was of a British nature, based upon the philosophy of the 18<sup>th</sup> century Isaac Newton, and that of the electron as quantified by J.J. Thompson in 1900. This was the scene of electronics, a field that would stand apart from electricity.

3) The wireless of the Bay area was that of the hydrogen plasma (arc) of the Federal Company or the thermionic electron tube of Heintz-Kaufmann. Electrical systems like the disrupting discharge or Alexanderson Alternator were never utilized for major stations. The hydrogen arc of Valdimar Poulsen has an interesting line of progress, and the South Bay had its first high power arc station in 1912, two years before Marconi took up Bolinas operation. Federal Telegraph Company's "Federal Arc" was to become standard equipment in many U.S. Navy high power stations, with megawatt units being produced. These would be the highest power wireless devices ever produced. The thermionic electron tube of Lee De-Forest was to become the more manageable method of producing wireless currents. This was to see extensive development in the Bay area and lead to famous companies like Eimac and Varian Associates. The merge of the arc and the electron tube led to the development of the giant particle accelerators that helped give the Bay area its fame. The primordial electron tube industry grew into the area's billion dollar semi-conductor industry known as Silicon Valley. This is the land of electronics.

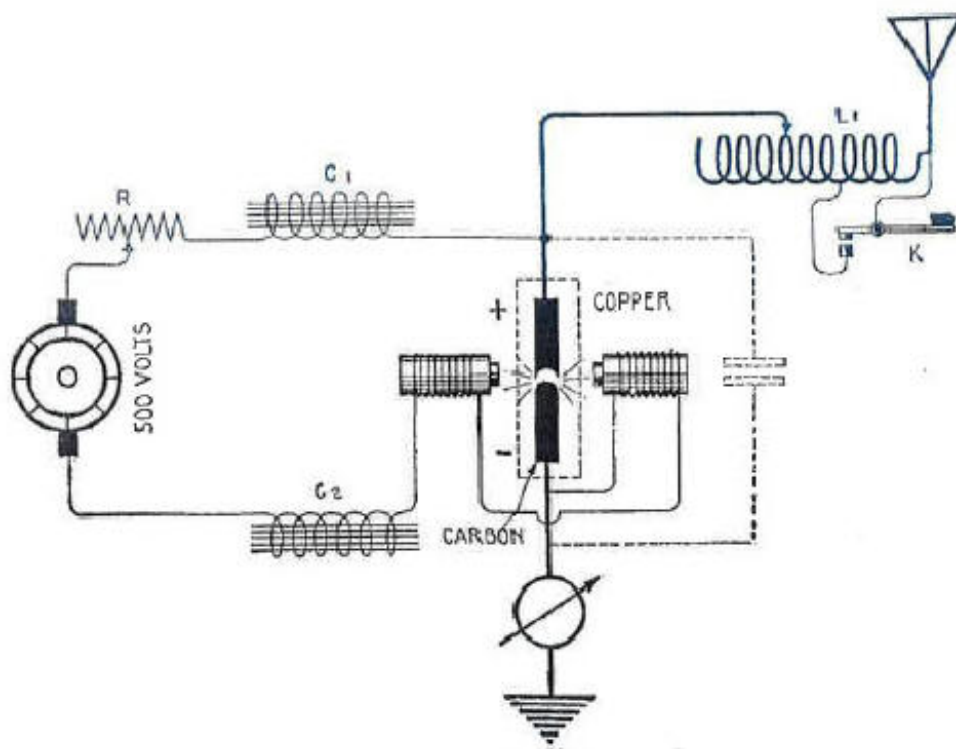

Complete Circuits of a Modern Arc Transmitter.



4) The thermionic electron tube, or vacuum tube, as it would be called, finds its origin in the experiments of Thomas Alva Edison, the wizard of Menlo Park, N.J. Edison was plagued by a mysterious blackening of the interior of his lamps during the course of their operation. This would shorten the life of the lamp which was not that long to begin with. Edison placed a small metal plate within the vacuum space of the lamp with a connecting wire leading to the outside. He found that a small current could be drawn off of the metal plate, but the plate would take no current supplied to it. This was to be like a check valve for electric current, allowing only a unidirectional flow. This became known as the Edison effect. Edison did nothing with his discovery since he found the source of blackening to be corpuscular emissions from the hot electrified filament. This is what is now called thermionic emission.

John A. Fleming, a friend of Marconi, was to pick up where Edison had left off. He developed the Edison effect into lamps that would detect wireless impulses: the diode detector tube. It would replace the erratic semi-conductor detectors of the sulphide variety in use at that time. Fleming created the diode rectifier, a device converting alternating current into direct current. Lee De.-Forest, among others, began experimentation with ways to regulate the corpuscular (electronic) flow. Vreeland and Alexanderson would use external magnetic fields but these were slow. De-Forest would place a screen in the path of the filament-to-plate flow, at the plate. Here was the telescope of the wireless, and the electronic amplifier was born. This was the single most important development in the history of radio, and was the birth of electronics.

5) The grid controlled thermionic vacuum bulb became known as the triode because of its three principle elements: the lighted filament, the control grid, and the collecting plate. This, as a three-terminal device, was a radical departure from the normal two-terminal arrangement in wireless. De-Forest was to patent his triode, or audion, as it was called, and patent its use as an electronic amplifier. These patents were to be purchased by the American Telephone and Telegraph Company. Here they would play an important role in the development of the telephone repeater and long distance telephony. General Electric would begin development of the bulbs of Fleming and De-Forest into units of great power flow. The Fleming diode would become the kenotron of G.E. Units would be developed that could convert many kilowatts of alternating current into direct current, at potentials of 100 kilovolts. The De-Forest audion would become the G.E. pliotron, capable of producing up to 20 kilowatts of high frequency alternating currents. G.E. had adapted these wireless devices into power handling units for the electric power industry.

6) General Electric was not able to go as far as they would have liked with the pliotron, since it was under patent protection by A.T.T. and De-Forest. The birth

of R.C.A. required adjustment of the patent arrangement so R.C.A. could use and manufacture radio tubes. A patent trust was formed to hold the De-Forest patents for use by the major corporations only. A.T.T., R.C.A., G.E., Westinghouse and Delco would share in the trust. The San Francisco inventors were left out in the cold. Heintz and his company, H & K, out of the sheer necessity of keeping their wireless sets operating, developed a gridless triode which they called a Gammatron. Gamma is the third letter of the Greek alphabet. It would use a control plate. Farnsworth would develop a diode amplifier, going back to the two-terminal like the arc. Not only did Farnsworth eliminate the grid, but to the amazement of all, he also eliminated the filament. He would call this the multipactor. It operated on secondary emission rather than thermionic emission. It ran cold, wasting no power. The Farnsworth multipactor was to lead to important advances in fusion technology. The U.S. Justice Department levied an anti-trust suit against R.C.A. and broke the patent trust in November of 1932. Now the electron tube would flourish in the Bay area. The klystron, magnetron, traveling wave tube, multipactor and the Eimac tube, along with countless others, were to spring forth during the following decades. The Bay area played the principle role in these developments.

DEFLECTION  
ELECTRODE

LEE  
DE-FOREST  
AND HIS  
AUDION  
TUBE







PERHAM  
FOUNDATION

De Forest at age 8.



PERHAM  
FOUNDATION

De Forest at age 17.

"Soon, we believe, the suckers will begin to bite!" wrote Lee de Forest as the company bearing his name began selling stock. Here he appears with an assistant before one of his wireless telegraph offices.



ANTIQUE WIRELESS ASSOCIATION



DE-FOREST WITH SARNOFF

ANTIQUÉ WIRELESS ASSOCIATION

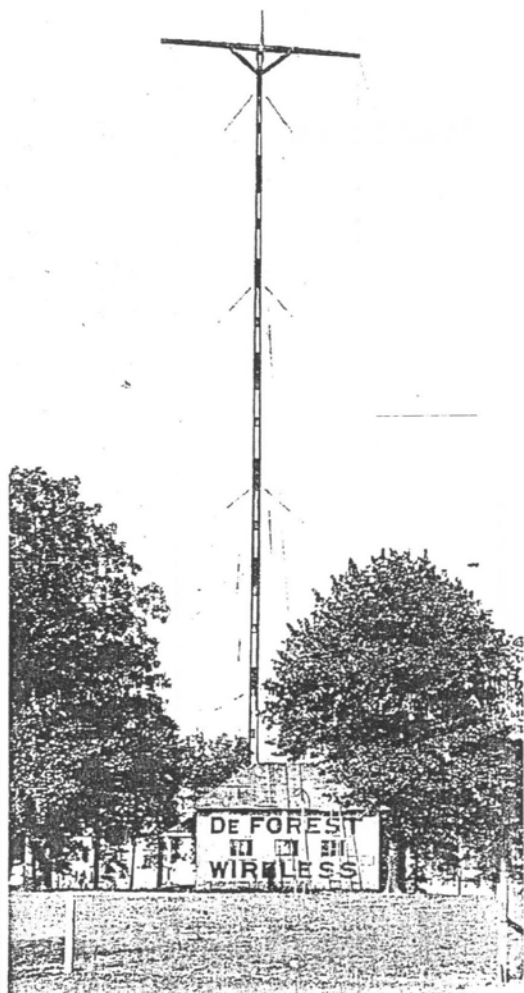

A  
STATION IN THE  
SERIES THAT  
GAVE US PH  
(KPH)



## De Forest Wireless Telegraph Co.

Parent Company

Capital, \$3,000,000

300,000 Shares

PAR VALUE, TEN DOLLARS PER SHARE  
Full Paid and Non-Assessable

### Officers

A. WHITE	President
LEE DE FOREST	Vice-President
C. C. GALBRAITH	Vice-President
HARRY E. WISE	Treasurer
FRANCIS X. BUTLER	Secretary

### Directors

A. WHITE, President Greater N. Y. Security Co.	JAMES STEWART, Representing Armour & Co.
HENRY DOSCHER, Formerly Docher Sugar Refining Co.	DR. S. V. ABELL,
C. C. GALBRAITH, Formerly with Armour & Co.	LEE DE FOREST, Scientific Director.
S. S. BOGART, Formerly Superintendent Western Union Telegraph Co.	FRANCIS X. BUTLER, JOHN FIRTH.



THE  
PRIMORDIAL  
RADIO TUBE

T. A. EDISON.  
Electric-Lamp.

No. 223,898.

Patented Jan. 27, 1880.

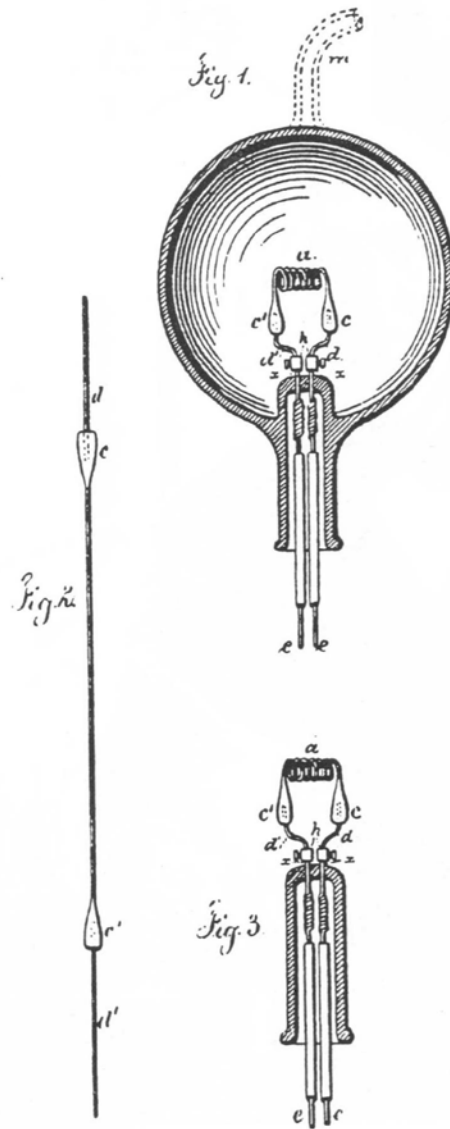

Witnesses

Chas. H. Smith  
Geo. P. McKinley

Inventor

Thomas A. Edison

per Lemuel W. Serrett



1918, Edison stands next to his workbench holding the bulb he used in 1875 to demonstrate the "Edison effect."

EDISON EFFECT  
BULBS (1875)



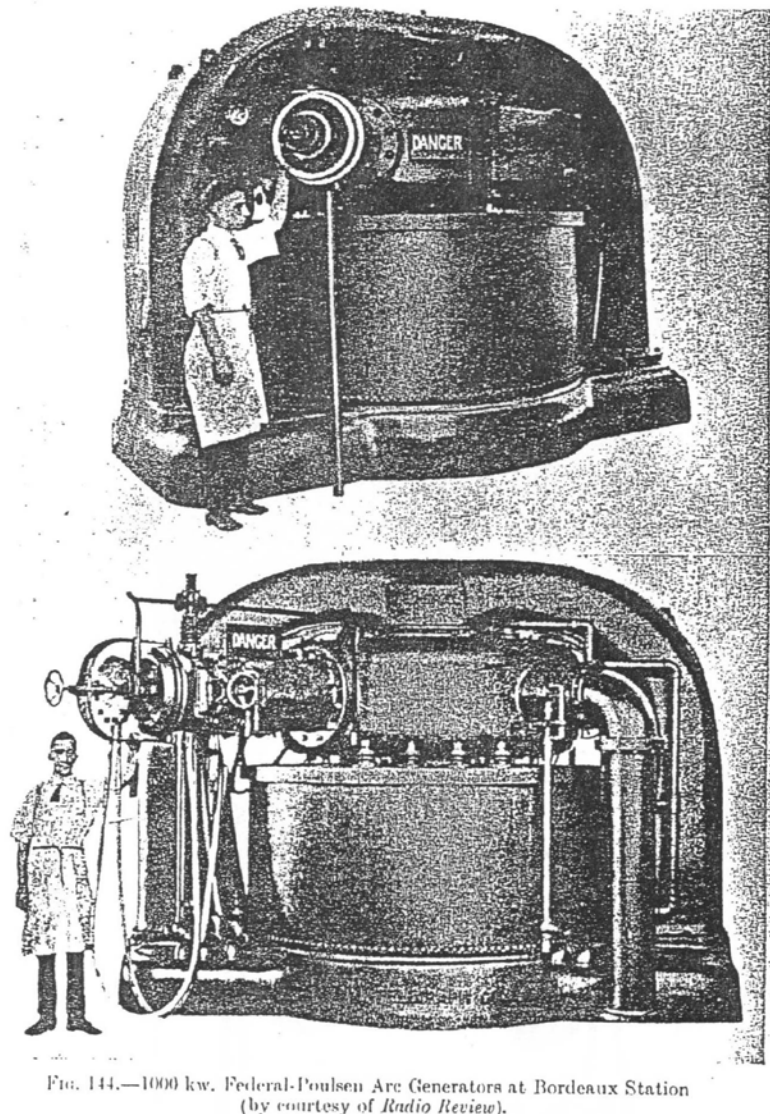

FIG. 144.—1000 kw. Federal-Poulsen Arc Generators at Bordeaux Station  
(by courtesy of *Radio Review*).

THE  
FEDERAL  
ARC

(LATER TO  
BECOME  
THE LAWRENCE  
CYCLOTRON)

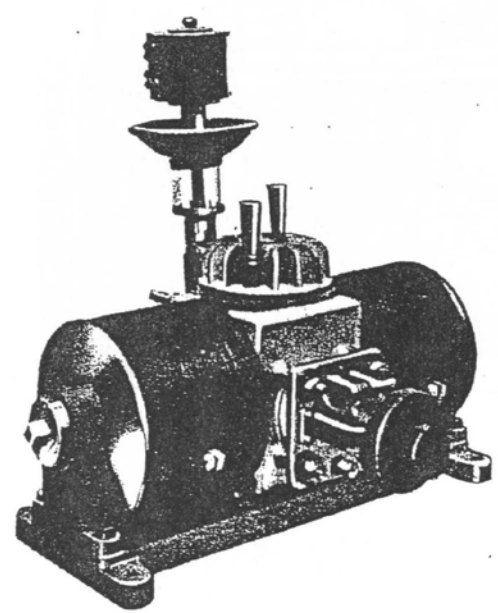

FIG. 56.—2 kw. Elwell-Poulsen Arc Generator.

76

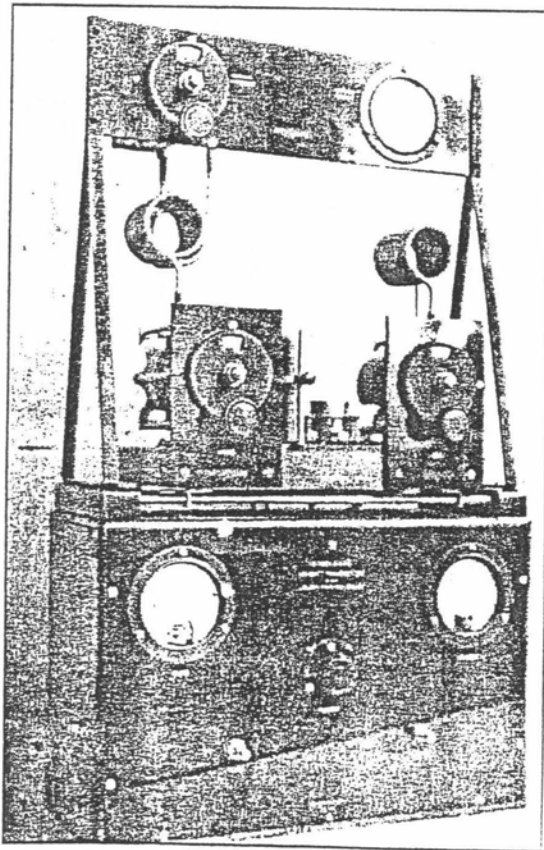
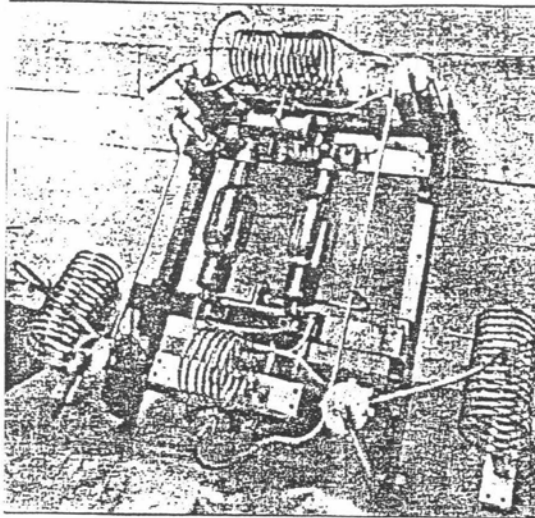

Photo C. H&K Bumblebee transmitter, front view.

H & K  
FIRST  
RIG



Aug. 31, 1937.

P. T. FARNSWORTH

2,091,439

MULTIFACTOR OSCILLATOR AND AMPLIFIER

Filed Feb. 24, 1936

2 Sheets-Sheet 2

Fig. 3.

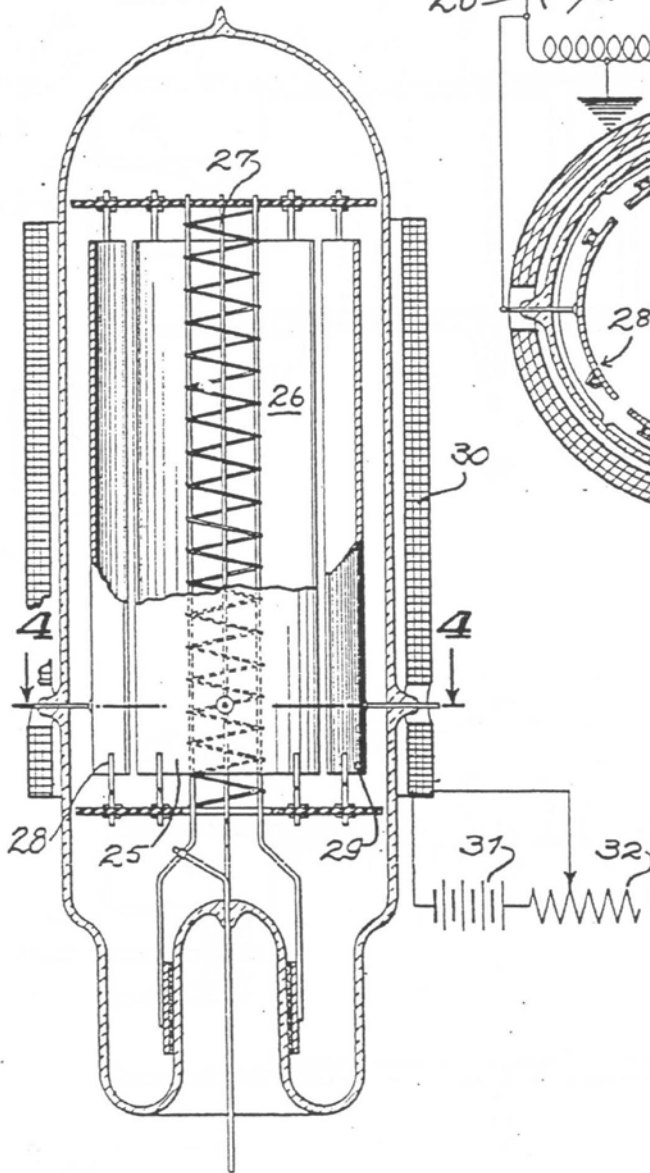

Fig. 4.

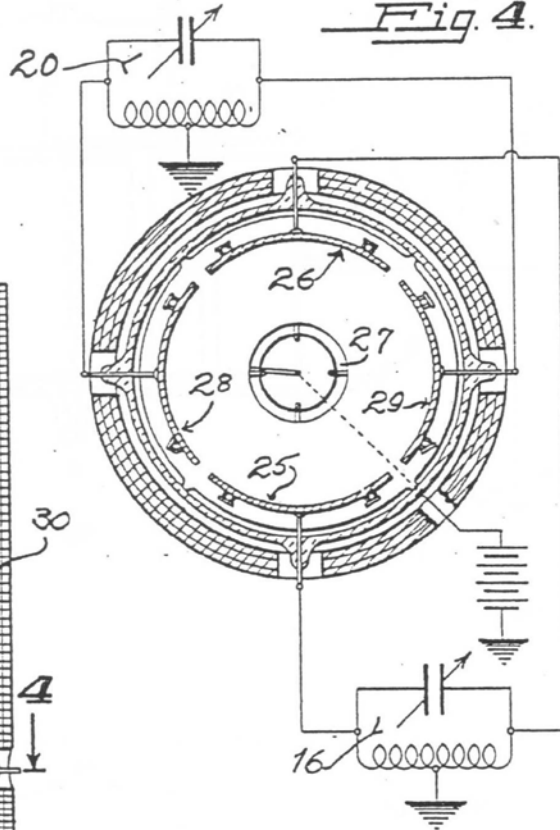

FIG  
26 B

INVENTOR.  
PHILO T. FARNSWORTH.  
BY  
*Lippincott & Metcalf*  
ATTORNEYS.

Aug. 31, 1937.

P. T. FARNSWORTH

2,091,439

MULTIFACTOR OSCILLATOR AND AMPLIFIER

Filed Feb. 24, 1936

2 Sheets-Sheet 1

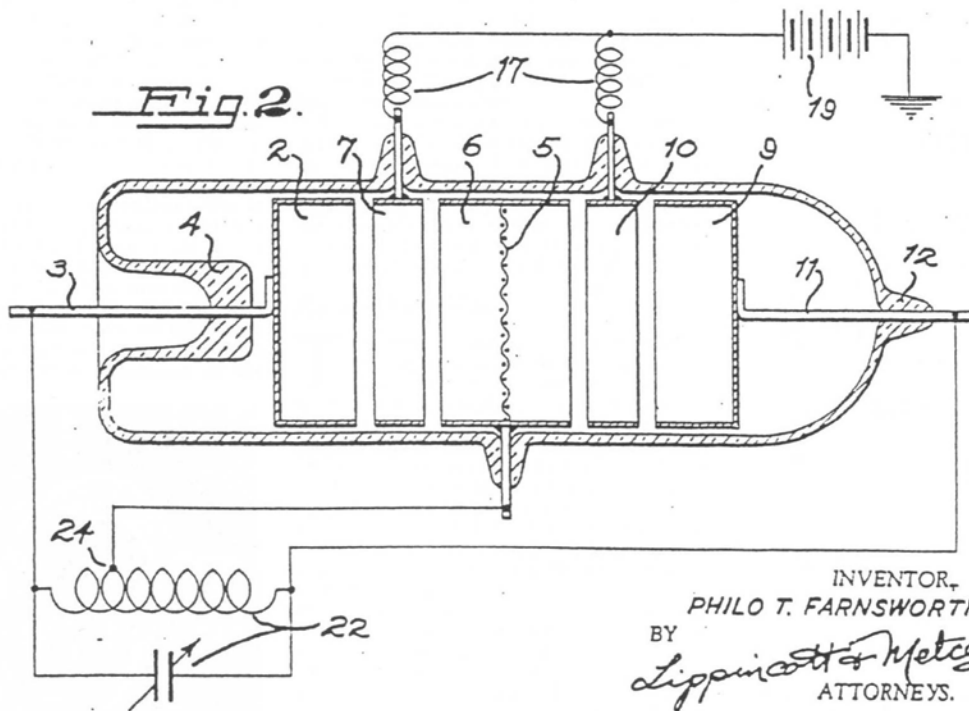
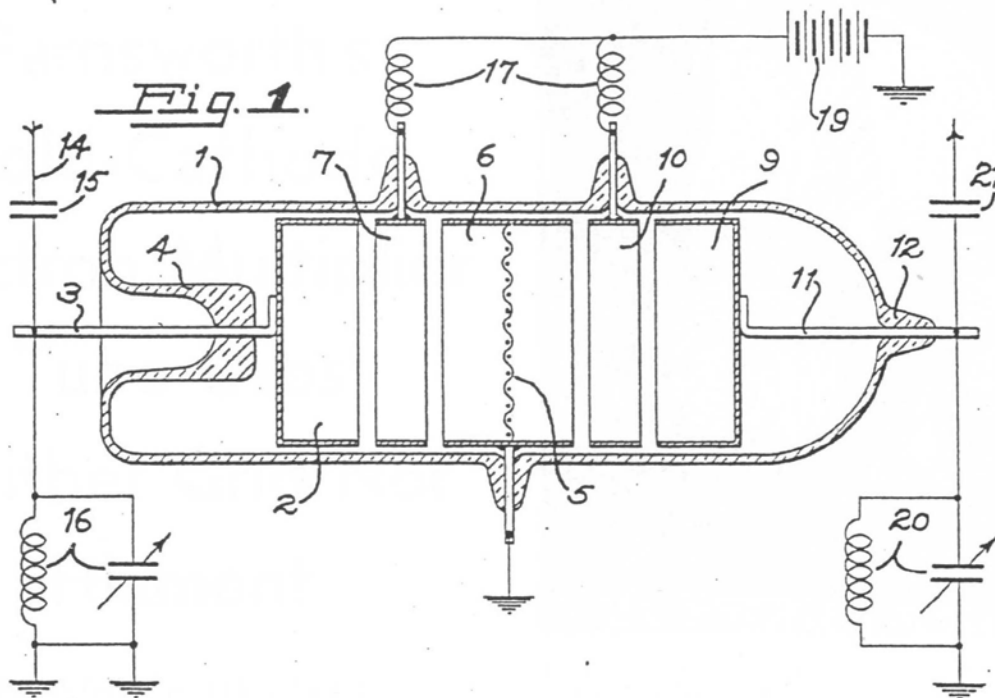

INVENTOR,  
PHILO T. FARNSWORTH.  
BY  
*Lippincott & Metcalf*  
ATTORNEYS.

FIG 26 C 145





# Farnsworth's Cold-Cathode Electron Multiplier Tube Uses Neither Grid Nor Filament

By ARTHUR H. HALLORAN



Ralph M. Heintz (center) explains the operation of the Farnsworth Cold Cathode Tube to Bernard H. Linden (left), U. S. Radio Inspector and Donald Lippincott (right), director of Television Laboratories, Inc.

THINK of a vacuum tube without filament or grid, thus requiring neither an A nor a C battery, which generates high-frequency oscillations! This is what P. T. Farnsworth, the television genius, accomplishes with the cold-cathode tube which he originally developed as a current-amplifier for use with his cathode-ray pickup tube. It is also an exceedingly efficient detector and modulator.

Its first public use as an oscillator was in a radio circuit whereby communication was maintained between San Francisco and Honolulu and between San Francisco and New York on September 13, 1934, over the Globe Wireless 35-meter channel. In this test, with 30 milliamperes at 1100 volts on the anode, the tube drove a pair of 150-watt tubes in the final amplifier of a transmitter at the

Heintz & Kaufmann factory in South San Francisco. The signals were received at both Honolulu and New York, and were reported as R9 by a ship 500 miles west of Honolulu. Wilkens of Dunedin, New Zealand, also heard the transmissions.

Previous laboratory tests proved that the tube is capable of generating oscillations of any desired frequency throughout the range from 200 kilocycles to 60 megacycles, these limits being set only by the dimensions of the available tuned circuits. An undistorted output of 25 watts was obtained from an input of 25 watts. 100%!

## As an Amplifier

THE performance of this new type of tube depends upon the emission of secondary electrons from two cathodes which are bombarded with high-velocity primary electrons. The cathodes are coated with caesium silver oxide to enhance secondary emission. They, together with a central ring anode, are assembled in an evacuated glass tube. The tube is placed within a solenoid which is supplied with direct current so as to maintain an intense magnetic field throughout the length of the tube. When used as an amplifier, a high frequency voltage is applied to the cathode terminals and a D.C. voltage is applied to the anode terminal to hold it at a positive potential with respect to the cathodes, which are shunted by a coil and variable condenser in parallel. The shunt circuit is tuned so as to be in resonance for the applied high frequency voltage.

When the DC voltage is applied to the anode terminal, any free electrons in the inter-electrode space would immediately be drawn to the anode were it not that the longitudinal magnetic field neutralizes the transverse electrostatic field from the anode and

were it not for the high-frequency electrostatic field which draws them to the alternately positively charged cathodes. The strength of these several fields can be adjusted to allow an electron to be shuttle back and forth in a zig-zag path between the

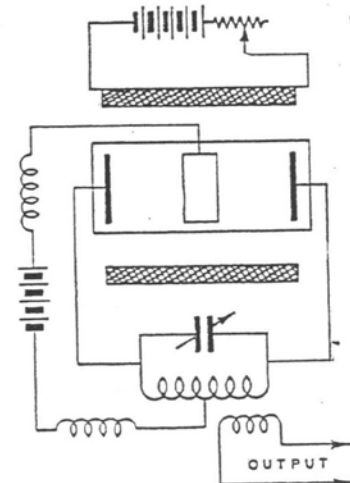

Oscillator circuit for cold cathode tube.

cathodes any desired number of times before it is finally drawn out of circulation at the anode.

Each time that a high velocity electron strikes a cathode it causes the emission of from 2 to 8 secondary electrons, the number of secondaries depending upon the velocity of the impacting electron, and thus

(Continued on page 14)

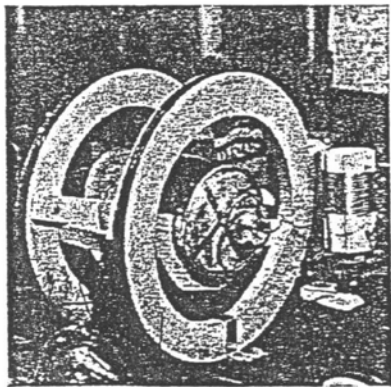

The Electron Multiplier as a high-frequency self-excited oscillator.

## Farnsworth Cold Cathode Tube

(Continued from page 6)

upon the amplitude of the voltage applied to the cathodes. Each emitted secondary, likewise causes the emission of more secondaries, so that the process is rapidly cumulative and gives rise to a tremendous amplification of current.

In the foregoing simplified account of the tube's operation as an amplifier, one important factor has been omitted. The anode attraction, which causes an electron to leave the vicinity of a cathode and which accelerates its velocity as it approaches the plane of the anode, also decelerates its velocity as it leaves the anode plane and approaches the second cathode, which is now positively charged so as to attract it. Its resultant velocity may therefore not be sufficient to cause emission from the second cathode. To insure emission, additional energy must be imparted to it, this energy being obtained from that stored in the resonant circuit, as indicated in the accompanying circuit diagram.

The high-frequency supply is of the order of 50 megacycles and is loosely coupled to the tuned circuit so as to apply from 25 to 90 volts across the cathode terminals. The positive potential on the anode may be 100 volts or more, depending upon the desired current output.

The tube has a discontinuous voltage-current output characteristic with a series of successively higher current peaks as the voltage is increased. Maximum current output is obtained when the anode voltage is just sufficient to allow an electron to travel from one cathode to the other during  $\frac{1}{2}$  cycle of the high frequency excitation. Other successively lower peaks occur at anode voltages corresponding to transit times of  $\frac{3}{2}$ ,  $\frac{5}{2}$ ,  $\frac{7}{2}$ ,  $\frac{9}{2}$  cycles, the last being the least which has yet been measured.

(Continued on page 18)

## Farnsworth Cold Cathode Tube

(Continued from page 14)

The external magnetic field is unnecessary when the cathodes are properly curved instead of being plane. Their curvature can be calculated to focus the electrons automatically for specified anode and cathode voltages. This eliminates the need of a DC supply for magnetic focusing.

The tube's theoretical output is twice that of an equivalent hot-cathode tube operated as a Class A amplifier. Its practical output is limited by the ability of the cathodes to withstand the high temperature to which they are subjected by bombardment from a rapidly increasing number of electrons. One test of a small tube showed an output of 100 watts of undistorted energy before the cathodes were destroyed by heat. Such destruction is prevented by means of resistors in the cathode leads. A small tube can be safely operated so as to deliver 45 milliamperes with 200 volts on the anode. It is to be noted that the tube operates as a current amplifier and that the amount of voltage amplification is dependent upon the resistance in the output circuit.

The theory of the tube's operation as a detector or modulator should be evident from the non-linear voltage-current characteristic and requires no elaboration here. It is especially sensitive in the detection of ultra-high frequencies.

IT IS a well known fact that any amplifier circuit generates oscillations when arranged to furnish an input voltage of proper magnitude and phase. Consideration of the manner in which Farnsworth's tube functions as an amplifier shows that it conforms to this requirement when connected to a resonant circuit which is tuned to a frequency whose half-period is equal to an electron's time of transit, as determined by the frequency of the oscillations applied to the cathodes.

But the great value of the Farnsworth tube resides in the fact that it is self-exciting, i.e., that it requires no external high frequency voltage when used as an oscillator. Aside from the energy which is required for the magnetic focusing field and which may not be needed eventually, the only external source of energy is that which maintains a positive potential on the anode. It apparently represents a new discovery in vacuum tube phenomena. Among engineers there is a difference of opinion as to its cause.

One plausible explanation is based on the assumption that there is no appreciable space charge effect in the tube when oscillations start. There are always some free electrons present in the inter-electrode space, if only those due to photoelectric emission from the cathodes. These are attracted by the anode when it becomes strongly positive but are prevented from immediately going to it by the longitudinal magnetic field. Their acceleration as they approach the plane of the

anode causes a current to flow, through half the inductance coil in the tuned circuit, to one cathode. This provides an out-of-phase voltage drop which accelerates the electrons toward the other cathode with sufficient velocity to cause secondary emission therefrom. The emitted electrons then establish a current flow through the other half of the mid-tapped coil and cause a voltage drop in opposite phase so as to accelerate the electrons toward the first cathode which is thus caused to emit more secondaries. Repetition of this process quickly builds the current up to a point where it can be delivered to the output circuit without stopping the internal oscillations. The oscillating frequency is that to which the resonant circuit is tuned. This explanation has not been confirmed by physicists, but is presented only as a means for visualizing possible actions in the tube. When engineers disagree, the physicist must experiment.

Much work has yet to be done before standardized tubes will be available for experimental use. Television Laboratories Ltd. has licensed two factories for commercial production. But it will probably be a matter of some months before tubes are available for amateur use.

NOTE THAT  
THIS TUBE  
IS 100%  
EFFICIENT!

FIG 26E



## **Chapter Six**

### **Nikola Tesla**

Author Commentary: pages 168 - 169

Historic Documents: pages 170 - 185

## VI) Nikola Tesla, 1856-1943

1) Any historic study of wireless leads to Nikola Tesla, yet his name is absent from most references on the subject. A brief summary of Tesla's life is presented here as a reference for historical purposes. Nikola Tesla was born at midnight on July 9-10, 1856 in the Serbian village of Smiljan, of the Austro-Hungarian border province of Lika. This area is now called Croatia. Tesla's parents had a long background as Serbian Orthodox clergy, and his father was a priest. Like so many others, Tesla arrived in New York City with but a few cents in his pockets. He was nearly turned back. A few years thereafter, in 1891, Tesla would become a U.S. citizen and value that above all the honors ever bestowed upon him. Tesla would quickly become the grandfather of 20<sup>th</sup> century technology. His induction motor and alternating current system (1888), would shape the industrial age. His Tesla Transformer (coil) and its electrostatic waves would bring him world fame (1893). His vast studies in the universities of Europe, the fact that he spoke dozens of languages fluently, his close contact with most prominent scientists and natural philosophers, and his own in-depth studies, made Tesla quite possibly the world's most educated man. Great scientists and the royalty of Europe would all pay homage to Tesla and his amazing New York laboratory. Tesla would be worth millions after his motor was created, and he became close with the New York elite. Samuel Clemens (Twain) was to become one of Tesla's closest friends. One can only wonder how someone of such stature could be so completely forgotten today.

2) Tesla's body was found in his New York hotel room a while after his death, in January, 1943. He had been hit by a taxi cab a few weeks earlier. Nikola Tesla was dead at the age of 87. Many scientific notables appeared at his funeral, even his theoretical rival, Albert Einstein. E.F.W. Alexanderson and Edwin Armstrong served as pall bearers to carry Tesla to his grave, where, like Marconi, he would be forgotten by science. Tesla's name was to reappear however, being taken up by the southern California U.F.O. cults as their Jesus Christ. Their claim was that Tesla was from Venus and he would return some day. This would serve to further the dislike for Tesla's name in scientific circles. This condition lasted from the mid-fifties to the mid-seventies. In the 70s Tesla's name appeared again, in a fantastic conspiracy which claimed the Soviets were using "Tesla scalar technology" for mind control of U.S. citizens, and for weather modification. This served to further cloud the actual work of Tesla. In the 80s, Tesla societies would appear, but were more interested in Einstein than Tesla. Such societies have run their course and are now gone. The creator of the 21<sup>st</sup> century technology is on his way to being lost forever. Bolinas is the last hope for any renewed understanding.



3) In any study of Tesla's history it has been found best to let him speak for himself. NIKOLA TESLA, "MY INVENTIONS"  
CHAPTER V



*Nikola Tesla in 1885, aged 29. The portrait is by Sarony, Tesla's favorite photographer. (Smithsonian Institution, National Museum of American History)*



*Tesla's birthplace. His father's church stands nearby. (Tesla Museum, Belgrade, Yugoslavia, photo by Professor P. S. Callahan)*

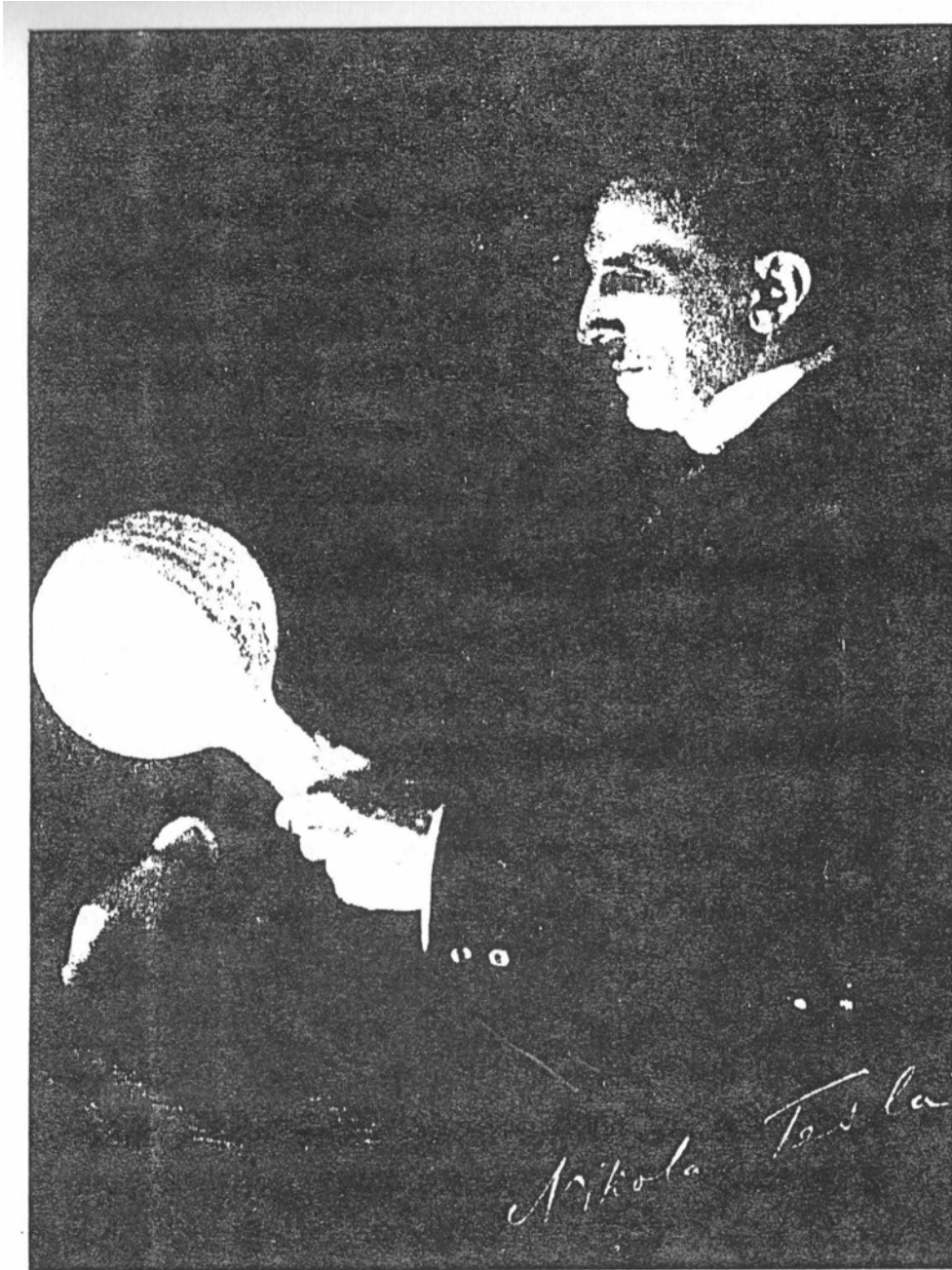

*Nikola Tesla and his famous wireless electric light. The gas-filled, phosphor-coated bulb anticipated in many respects the development, decades later, of fluorescent lighting.*



## V. THE MAGNIFYING TRANSMITTER

VOC

**A**S I review the events of my past life I realize how subtle are the influences that shape our destinies. An incident of my youth may serve to illustrate. One winter's day I managed to climb a steep mountain, in company with other boys. The snow was quite deep and a warm southerly wind made it just suitable for our purpose. We amused ourselves by throwing balls which would roll down a certain distance gathering more or less snow, and we tried to outdo one another in this exciting sport. Suddenly a ball was seen to go beyond the limit, swelling to enormous proportions until it became as big as a house and plunged thundering into the valley below with a force that made the ground tremble. I looked on spell bound, incapable of understanding what had happened. For weeks afterward the picture of the avalanche was before my eyes and I wondered how anything so small could grow to such an immense size. Ever since that time the magnification of feeble actions fascinated me, and when, years later, I took up the experimental study of mechanical and electrical resonance, I was keenly interested from the very start. Possibly, had it not been for that early powerful impression, I might not have followed up the little spark I obtained with my coil and never developed my best invention, the true history of which will tell here for the first time.

“Lionhunters” have often asked me which of my discoveries I prize most. This depends on the point of view. Not a few

;

technical men, very able in their special departments, but dominated by a pedantic spirit and nearsighted, have asserted that excepting the induction motor I have given to the world little of practical use. This is a grievous mistake. A new idea must not be judged by its immediate results. My alternating system of power transmission came at a psychological moment, as a long-sought answer to pressing industrial questions, and altho considerable resistance had to be overcome and opposing interests reconciled, as usual, the commercial introduction could not be long delayed. Now, compare this situation with that confronting my turbine, for example. One should think that so simple and beautiful an invention, possessing many features of an ideal motor, should be adopted at once and, undoubtedly, it would under similar conditions. But the prospective effect of the rotating field was not to render worthless existing machinery; on the contrary, it was to give it additional value. The system lent itself to new enterprise as well as to improvement of the old. My turbine is an advance of a character entirely different. It is a radical departure in the sense that its success would mean the abandonment of the antiquated types of prime movers on which billions of dollars have been spent. Under such circumstances the progress must needs be slow and perhaps the greatest impediment is encountered in the prejudicial opinions created in the minds of experts by organized opposition. Only the other day I had a disheartening experience when I met my friend and former assistant, Charles F. Scott, now professor of Electrical Engineering at Yale. I had not seen him for a long time and was glad to have an opportunity for a little chat at my office. Our conversation naturally enough drifted on my turbine and I became heated to a high degree. "Scott," I exclaimed, carried away by the vision of a glorious future, "my turbine will scrap all the heat-engines in the world." Scott stroked his chin and looked away thoughtfully, as though making a mental calculation. "That will make quite a pile of scrap," he said, and left without another word!

These and other inventions of mine, however, were nothing more than steps forward in certain directions. In

---



evolving them I simply followed the inborn instinct to improve the present devices without any special thought of our far more imperative necessities. The "Magnifying Transmitter" was the product of labors extending through years, having for their chief object the solution of problems which are infinitely more important to mankind than mere industrial development.

If my memory serves me right, it was in November, 1890, that I performed a laboratory experiment which was one of

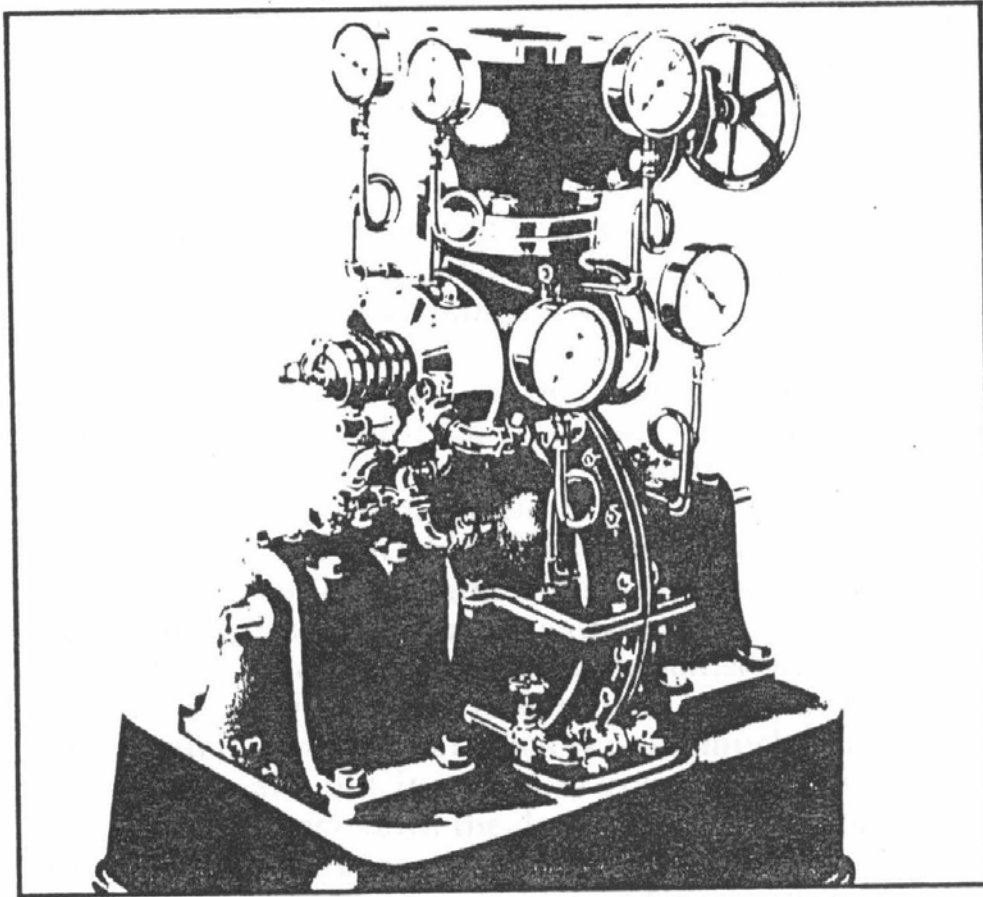

*Tesla's bladeless turbine. Within the central, pancake-shaped housing are several discs, like flat, very-closely-spaced cultivator discs, which are fixed to the driveshaft seen projecting on either side. When air, steam, or another gas is injected under pressure between the discs, surface adhesion smoothly transfers the kinetic energy of the gas to the discs, causing rotation. Operated in reverse, the device can function as a gas compressor. (Tesla Museum/Smithsonian Institution)*

the most extraordinary and spectacular ever recorded in the annals of science. In investigating the behaviour of high frequency currents I had satisfied myself that an electric field of sufficient intensity could be produced in a room to light up electrodeless vacuum tubes. Accordingly, a transformer was built to test the theory and the first trial proved a marvelous success. It is difficult to appreciate what those strange phenomena meant at that time. We crave for new sensations but soon become indifferent to them. The wonders of yesterday are today common occurrences. When my tubes were first publicly exhibited they were viewed with amazement impossible to describe. From all parts of the world I received urgent invitations and numerous honors and other flattering inducements were offered to me, which I declined.

But in 1892 the demands became irresistible and I went to London where I delivered a lecture before the Institution of Electrical Engineers. It had been my intention to leave immediately for Paris in compliance with a similar obligation, but Sir James Dewar insisted on my appearing before the Royal Institution. I was a man of firm resolve but succumbed easily to the forceful arguments of the great Scotchman. He pushed me into a chair and poured out half a glass of a wonderful brown fluid which sparkled in all sorts of iridescent colors and tasted like nectar. "Now," said he, "you are sitting in Faraday's chair and you are enjoying whiskey he used to drink." In both aspects it was an enviable experience. The next evening I gave a demonstration before that Institution, at the termination of which Lord Rayleigh addressed the audience and his generous words gave me the first start in these endeavors. I fled from London and later from Paris to escape favors showered upon me, and journeyed to my home where I passed through a most painful ordeal and illness. Upon regaining my health I began to formulate plans for the resumption of work in America. Up to that time I never realized that I possessed any particular gift of discovery but Lord Rayleigh, whom I always considered as an ideal man of science, had said so and if that was the case I felt that I should concentrate on some big idea.



One day, as I was roaming in the mountains, I sought shelter from an approaching storm. The sky became overhung with heavy clouds but somehow the rain was delayed until, all of a sudden, there was a lightning flash and a few moments after a deluge. This observation set me thinking. It was manifest that the two phenomena were closely related, as cause and effect, and a little reflection led me to the conclusion that the electrical energy involved in the precipitation of the water was inconsiderable, the function of lightning being much like that of a sensitive trigger. Here was a stupendous possibility of achievement. If we could produce electric effects of the required quality, this whole planet and the conditions of existence on it could be transformed. The sun raises the water of the oceans and winds drive it to distant regions where it remains in a state of most delicate balance. If it were in our power to upset it when and wherever desired, this mighty life-sustaining stream could be at will controlled. We could irrigate arid deserts, create lakes and rivers and provide motive power in unlimited amounts. This would be the most efficient way of harnessing the sun to the uses of man. The consummation depended on our ability to develop electric forces of the order of those in nature. It seemed a hopeless undertaking, but I made up my mind to try it and immediately on my return to the United States, in the summer of 1892, work was begun which was to me all the more attractive, because a means of the same kind was necessary for the successful transmission of energy without wires.

The first gratifying result was obtained in the spring of the succeeding year when I reached tensions of about 1,000,000 volts with my conical coil. That was not much in the light of the present art, but it was then considered a feat. Steady progress was made until the destruction of my laboratory by fire in 1895, as may be judged from an article by T. C. Martin which appeared in the April number of the *Century Magazine*. This calamity set me back in many ways and most of that year had to be devoted to planning and reconstruction. However, as soon as circumstances permitted, I returned to the task. Although I knew that higher electro-motive forces were attain-

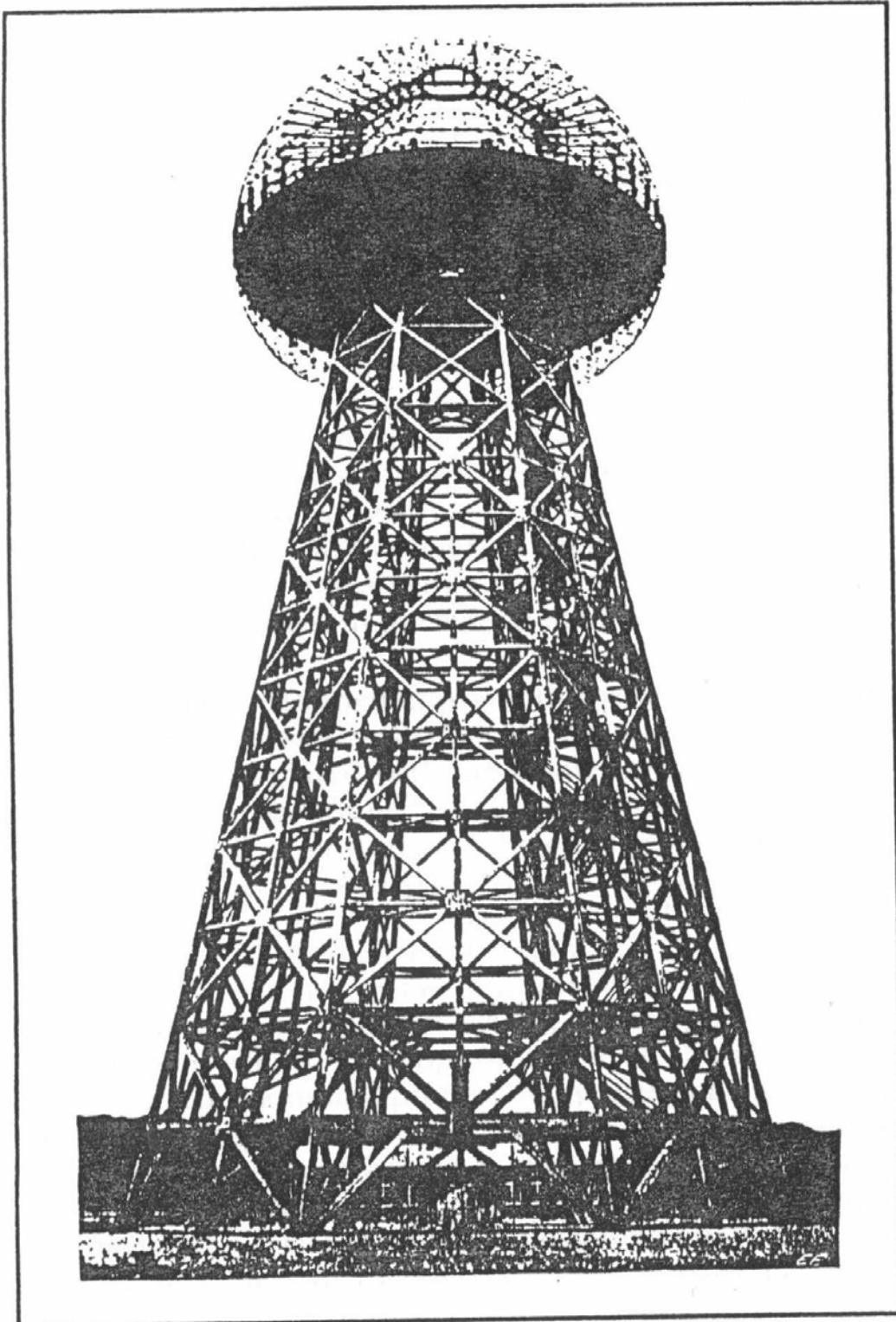

*Tesla's gigantic wireless transmitter tower, erected in 1901-1903 at Shoreham, Long Island as part of his never-completed "World Wireless System." The huge scale of the 187-foot tower (which was demolished in 1917) may be judged from the two-story power plant seen in the background.*



able with apparatus of larger dimensions, I had an instinctive perception that the object could be accomplished by the proper design of a comparatively small and compact transformer. In carrying on tests with a *secondary in the form of a flat spiral*, as illustrated in my patents, the absence of streamers surprised me, and it was not long before I discovered that this was due to the position of the turns and their mutual action. Profiting from this observation I resorted to the use of a high tension conductor with turns of considerable diameter sufficiently separated to keep down the distributed capacity, while at the same time preventing undue accumulation of the charge at any point. The application of this principle enabled me to produce pressures of 4,000,000 volts, which was about the limit obtainable in my new laboratory at Houston Street, as the discharges extended through a distance of 16 feet. A photograph of this transmitter was published in the *Electrical Review* of November, 1898. In order to advance further along this line I had to go into the open, and in the spring of 1899, having completed preparations for the erection of a wireless plant, I went to Colorado where I remained for more than one year. Here I introduced other improvements and refinements which made it possible to generate currents of any tension that may be desired. Those who are interested will find some information in regard to the experiments I conducted there in my article, "The Problem of Increasing Human Energy" in the *Century Magazine* of June, 1900, to which I have referred on a previous occasion.

I have been asked by the ELECTRICAL EXPERIMENTER to be quite explicit on this subject so that my young friends among the readers of the magazine will clearly understand the construction and operation of my "Magnifying Transmitter" and the purposes for which it is intended. Well, then, in the first place, it is a *resonant transformer* with a secondary in which the parts, charged to a high potential, are of considerable area and arranged in space along ideal enveloping surfaces of very large radii of curvature, and at proper distances from one another thereby insuring a *small electric surface density everywhere* so that *no leak can occur even if the conductor is*

*bare*. It is suitable for any frequency, from a few to many thousands of cycles per second, and can be used in the production of currents of tremendous volume and moderate pressure, or of smaller amperage and immense electro-motive force. The maximum electric *tension is merely dependent on the curvature of the surfaces* on which the charged elements are situated and the area of the latter.

Judging from my past experience, as much as 100,000,000 volts are perfectly practicable. On the other hand currents of many thousands of amperes may be obtained in the antenna. A plant of but very moderate dimensions is required for such performances. Theoretically, a terminal of less than 90 feet in diameter is sufficient to develop an electro-motive force of that magnitude while for antenna currents of from 2,000-4,000 amperes at the usual frequencies it need not be larger than 30 feet in diameter.

In a more restricted meaning this wireless transmitter is one in which the Hertz-wave radiation is an entirely negligible quantity as compared with the whole energy, under which condition the damping factor is extremely small and an enormous charge is stored in the elevated capacity. Such a circuit may then be excited with impulses of any kind, even of low frequency and it will yield sinusoidal and continuous oscillations like those of an alternator.

Taken in the narrowest significance of the term, however, it is a resonant transformer which, besides possessing these qualities, is accurately proportioned to fit the globe and its electrical constants and properties, by virtue of which design it becomes highly efficient and effective in the wireless transmission of energy. Distance is then absolutely eliminated, there being *no diminution in the intensity of the transmitted impulses*. It is even possible to make the actions *increase with the distance from the plant* according to an exact mathematical law.

This invention was one of a number comprised in my "World-System" of wireless transmission which I undertook to commercialize on my return to New York in 1900. As to the immediate purposes of my enterprise, they were clearly out-



lined in a technical statement of that period from which I quote:

“The ‘World-System’ has resulted from a combination of several original discoveries made by the inventor in the course of long continued research and experimentation. It makes possible not only the instantaneous and precise wireless transmission of any kind of signals, messages or characters, to all parts of the world, but also the inter-connection of the existing telegraph, telephone, and other signal stations without any change in their present equipment. By its means, for instance, a telephone subscriber here may call up and talk to any other subscriber on the Globe. An inexpensive receiver, not bigger than a watch, will enable him to listen anywhere, on land or sea, to a speech delivered or music played in some other place, however distant. These examples are cited merely to give an idea of the possibilities of this great scientific advance, which annihilates distance and makes that perfect natural conductor, the Earth, available for all the innumerable purposes which human ingenuity has found for a line-wire. One far-reaching result of this is that any device capable of being operated thru one or more wires (at a distance obviously restricted) can likewise be actuated, without artificial conductors and with the same facility and accuracy, at distances to which there are no limits other than those imposed by the physical dimensions of the Globe. Thus, not only will entirely new fields for commercial exploitation be opened up by this ideal method of transmission but the old ones vastly extended.

“The ‘World-System’ is based on the application of the following important inventions and discoveries:

“1. *The ‘Tesla Transformer.’* This apparatus is in the production of electrical vibrations as revolutionary as gunpowder was in warfare. Currents many times stronger than any ever generated in the usual ways, and sparks over one hundred feet long, have been produced by the inventor with an instrument of this kind.

“2. *The ‘Magnifying Transmitter.’* This is Tesla’s best invention—a peculiar transformer specially adapted to excite the Earth, which is in the transmission of electrical energy what the telescope is in astronomical observation. By the use of this marvelous device he has already set up electrical movements of greater intensity than those of lightning

and passed a current, sufficient to light more than two hundred incandescent lamps, around the Globe.

"3. *The 'Tesla Wireless System.'* This system comprises a number of improvements and is the only means known for transmitting economically electrical energy to a distance without wires. Careful tests and measurements in connection with an experimental station of great activity, erected by the inventor in Colorado, have demonstrated that power in any desired amount can be conveyed, clear across the Globe if necessary, with a loss not exceeding a few per cent.

"4. *The 'Art of Individualization.'* This invention of Tesla is to primitive 'tuning' what refined language is to unarticulated expression. It makes possible the transmission of signals or messages absolutely secret and exclusive both in the active and passive aspect, that is, non-interfering as well as non-interferable. Each signal is like an individual of unmistakable identity and there is virtually no limit to the number of stations or instruments which can be simultaneously operated without the slightest mutual disturbance.

"5. *'The terrestrial Stationary Waves.'* This wonderful discovery, popularly explained, means that the Earth is responsive to electrical vibrations of definite pitch just as a tuning fork to certain waves of sound. These particular electrical vibrations, capable of powerfully exciting the Globe, lend themselves to innumerable uses of great importance commercially and in many other respects.

"The first 'World-System' power plant can be put in operation in nine months. With this power plant it will be practicable to attain electrical activities up to ten million horsepower and it is designed to serve for as many technical achievements as are possible without due expense. Among these the following may be mentioned:

"(1) The inter-connection of the existing telegraph exchanges or offices all over the world;

"(2) The establishment of a secret and non-interferable government telegraph service;

"(3) The inter-connection of all the present telephone exchanges or offices on the Globe;

"(4) The universal distribution of general news, by



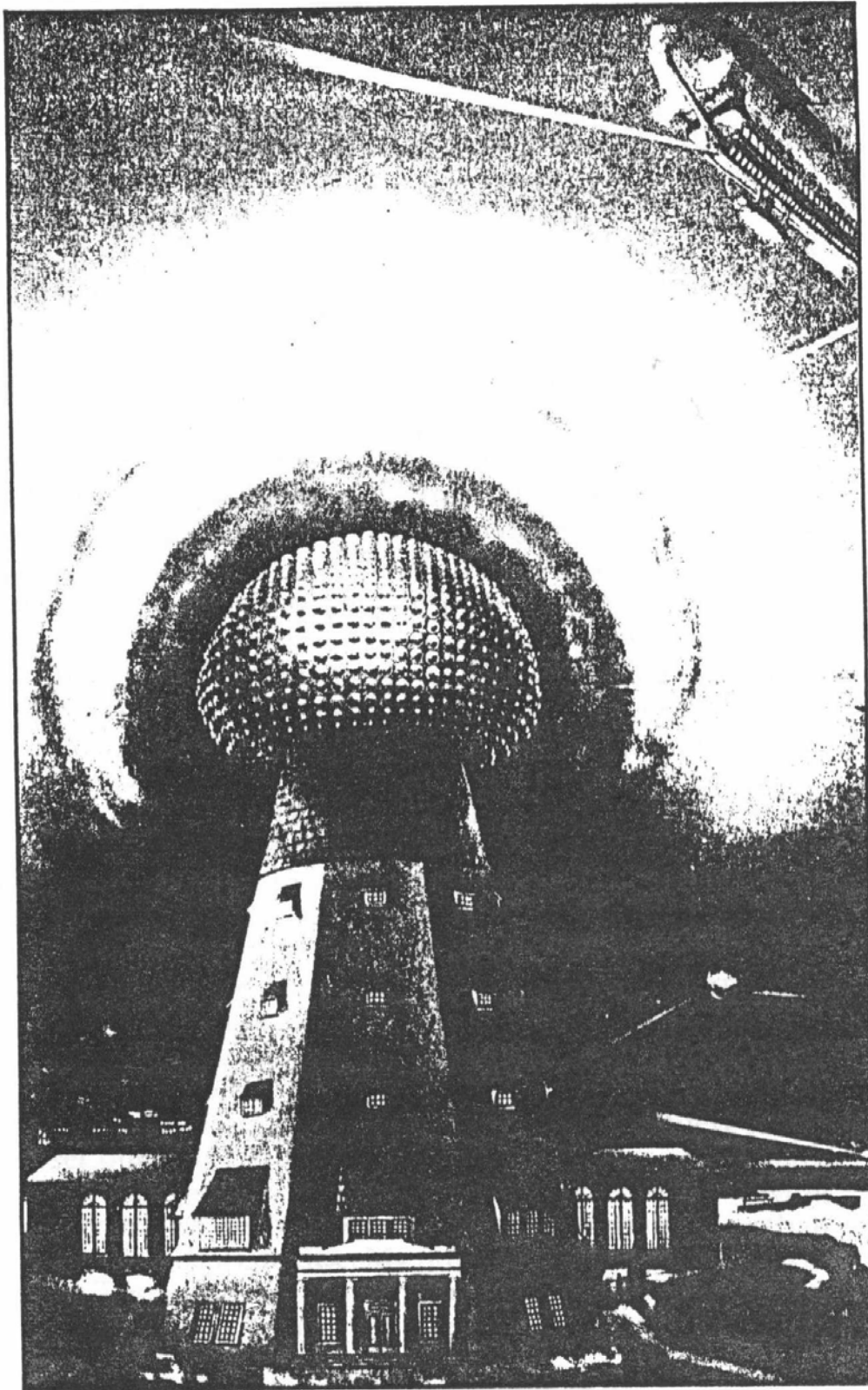

*Artist Frank Paul's conception of how the completed Long Island tower might have looked.*

telegraph or telephone, in connection with the Press;

“(5) The establishment of such a ‘World-System’ of intelligence transmission for exclusive private use;

“(6) The inter-connection and operation of all stock tickers of the world;

“(7) The establishment of a ‘World-System’ of musical distribution, etc.;

“(8) The universal registration of time by cheap clocks indicating the hour with astronomical precision and requiring no attention whatever;

“(9) The world transmission of typed or handwritten characters, letters, checks, etc.;

“(10) The establishment of a universal marine service enabling the navigators of all ships to steer perfectly without compass, to determine the exact location, hour and speed, to prevent collisions and disasters, etc.;

“(11) The inauguration of a system of world-printing on land and sea;

“(12) The world reproduction of photographic pictures and all kinds of drawings or records.”

I also proposed to make demonstrations in the wireless transmission of power on a small scale but sufficient to carry conviction. Besides these I referred to other and incomparably more important applications of my discoveries which will be disclosed at some future date.

A plant was built on Long Island with a tower 187 feet high, having a spherical terminal about 68 feet in diameter. These dimensions were adequate for the transmission of virtually any amount of energy. Originally only from 200 to 300 K.W. were provided but I intended to employ later several thousand horsepower. The transmitter was to emit a wave-complex of special characteristics and I had devised a unique method of telephonic control of any amount of energy.

The tower was destroyed two years ago but my projects are being developed and another one, improved in some features, will be constructed. On this occasion I would contradict the widely circulated report that the structure was demolished by the Government which owing to war conditions, might have created prejudice in the minds of those who may not



know that the papers, which thirty years ago conferred upon me the honor of American citizenship, are always kept in a safe, while my orders, diplomas, degrees, gold medals and other distinctions are packed away in old trunks. If this report had a foundation I would have been refunded a large sum of money which I expended in the construction of the tower. On the contrary it was in the interest of the Government to preserve it, particularly as it would have made possible—to mention just one valuable result—the location of a submarine in any part of the world. My plant, services, and all my improvements have always been at the disposal of the officials and ever since the outbreak of the European conflict I have been working at a sacrifice on several inventions of mine relating to aerial navigation, ship propulsion and wireless transmission which are of the greatest importance to the country. Those who are well informed know that my ideas have revolutionized the industries of the United States and I am not aware that there lives an inventor who has been, in this respect, as fortunate as myself especially as regards the use of his improvements in the war. I have refrained from publicly expressing myself on this subject before as it seemed improper to dwell on personal matters while all the world was in dire trouble. I would add further, in view of various rumors which have reached me, that Mr. J. Pierpont Morgan did not interest himself with me in a business way but in the same large spirit in which he has assisted many other pioneers. He carried out his generous promise to the letter and it would have been most unreasonable to expect from him anything more. He had the highest regard for my attainments and gave me every evidence of his complete faith in my ability to ultimately achieve what I had set out to do. I am unwilling to accord to some small-minded and jealous individuals the satisfaction of having thwarted my efforts. These men are to me nothing more than microbes of a nasty disease. My project was retarded by laws of nature. The world was not prepared for it. It was too far ahead of time. But the same laws will prevail in the end and make it a triumphal success.



# Electric Spacecraft

A Journal of Interactive Research

Apr/May/June Issue 26 Published Sept. 14, 1998

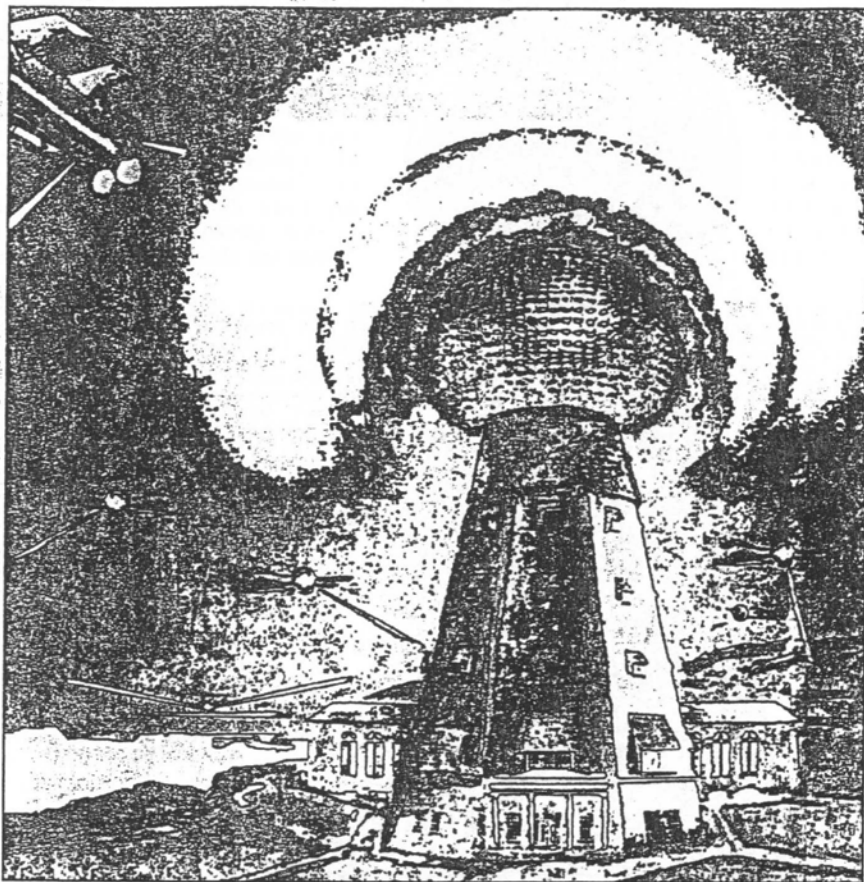

RARE NOTES FROM TESLA on wardencllyffe

LABORATORY INVESTIGATIONS of specially-conditioned EM fields

the wallace inventions, spin aligned nuclei, the gravitomagnetic field, and the tampere experiment: IS THERE A CONNECTION?

physical significance of the VECTOR POTENTIAL

ENERGY and CHARGE

86



# My Inventions

## By Nikola Tesla

### V. The Magnifying Transmitter

AS I review the events of my past life I realize how subtle are the influences that shape our destinies. An incident of my youth may serve to illustrate. One winter's day I managed to climb a steep mountain, in company with other boys. The snow was quite deep and a warm southerly wind made it just suitable for our purpose. We amused ourselves by throwing balls which would roll down a certain distance, gathering more or less snow, and we tried to outdo one another in this exciting sport. Suddenly a ball was seen to go beyond the limit, swelling to enormous proportions until it became as big as a house and plunged thundering into the valley below with a force that made the ground tremble. I looked on spell-bound, incapable of understanding what had happened. For weeks afterward the picture of the avalanche was before my eyes and I wondered how anything so small could grow to such an immense size. Ever since that time the magnification of feeble actions fascinated me, and when, years later, I took up the experimental study of mechanical and electrical resonance, I was keenly interested from the very start. Possibly, had it not been for that early powerful impression, I might not have followed up the little spark I obtained with my coil and never developed my best invention, the true history of which I will tell here for the first time.

This Photograph Shows the Famous Tesla Tower Erected at Shoreham, L. I., N. Y. The Tower Was Dismantled at the Outbreak of the War. It Was 187 Feet High. The Spherical Top Was 68 Feet in Diameter.

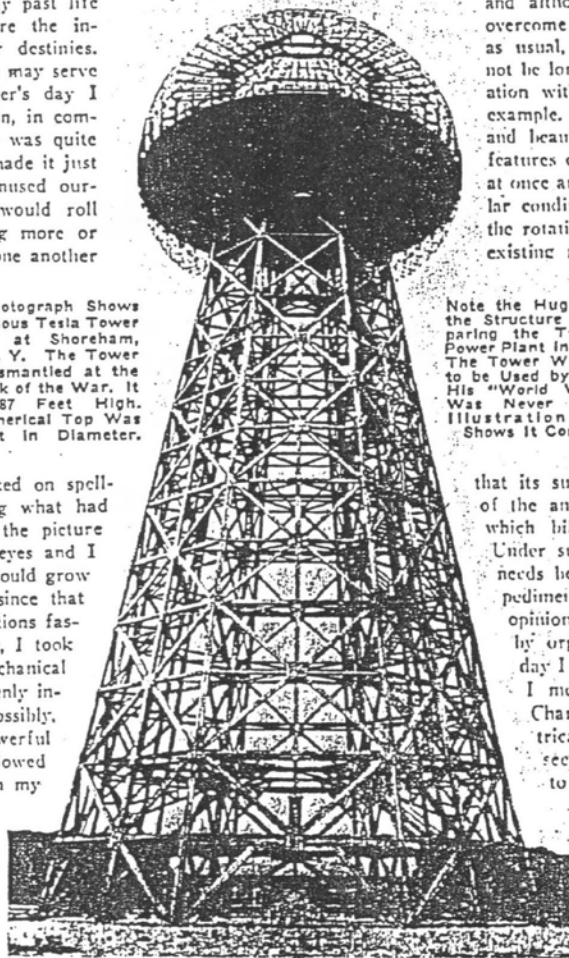

Note the Huge Size of the Structure by Comparing the Two-story Power Plant in the Rear. The Tower Which Was to be Used by Tesla in His "World Wireless," Was Never Finished. Illustration Opposite Shows It Completed.

and altho considerable resistance had to be overcome and opposing interests reconciled, as usual, the commercial introduction could not be long delayed. Now, compare this situation with that confronting my turbine, for example. One should think that so simple and beautiful an invention, possessing many features of an ideal motor, should be adopted at once and, undoubtedly, it would under similar conditions. But the prospective effect of the rotating field was not to render worthless existing machinery; on the contrary, it was to give it additional value. The system lent itself to new enterprise as well as to improvement of the old. My turbine is an advance of a character entirely different. It is a radical departure in the sense

that its success would mean the abandonment of the antiquated types of prime movers on which billions of dollars have been spent. Under such circumstances the progress must needs be slow and perhaps the greatest impediment is encountered in the prejudicial opinions created in the minds of experts by organized opposition. Only the other day I had a disheartening experience when I met my friend and former assistant, Charles F. Scott, now professor of Electrical Engineering at Yale. I had not seen him for a long time and was glad to have an opportunity for a little chat at my office. Our conversation naturally enough drifted on my turbine and I became heated to a high degree. "Scott," I exclaimed, carried away by the vision of a glorious future, "my turbine will scrap all the heat-engines in the world." Scott stroked his chin and looked away thoughtfully, as though making a mental calculation. "That will make quite a pile of scrap," he said, and left without another word!

"Aladdin's Lamp".

These and other inventions of mine, however, were nothing more than steps forward in certain directions. In evolving them I simply fol-

Scrapping the World's Engines.

"Lionhunters" have often asked me which of my discoveries I prize most. This depends on the point of view. Not a few technical men, very able in their special departments, but dominated by a pedantic spirit and near-sighted, have asserted that excepting the induction motor I have given to the world little of practical use. This is a grievous mistake. A new idea must not be judged by its immediate results. My alternating system of power transmission came at a psychological moment, as a long-sought answer to pressing industrial questions.

This depends on the point of view. Not

*IMAGINE a man a century ago, bold enough to design and actually build a huge tower with which to transmit the human voice, music, pictures, press news and even power, thru the earth to any distance whatever without wires! He probably would have been hung or burnt at the stake. So when Tesla built his famous tower on Long Island he was a hundred years ahead of his time. And foolish ridicule by our latter day arm-chair "savants," does not in the least mar Tesla's greatness.*

*The titanic brain of Tesla has hardly produced a more amazing wonder than this "magnifying transmitter." Contrary to popular belief his tower was not built to radiate Hertzian waves into the ether. Tesla's system sends out thousands of horsepower thru the earth—he has shown experimentally how power can be sent without wires over distances from a central point. Nor is there any mystery about it how he accomplishes the result. His historic U. S. patents and articles describe the method used. Tesla's Magnifying Transmitter is truly a modern lamp of Aladdin.*

EDITOR.

lowed the inborn instinct to improve the present devices without (Continued on page 148)

## **Chapter Seven**

### **The Commonwealth Question**

Author Commentary: pages 187 - 195

Historic Documents: pages 196 - 221



National Park Service  
Michael Auer  
Northwest Suite 200  
Washington D.C. 20002

Dear Mr. Auer;

Please allow me to bring the following matters to your attention:

I.) INTRODUCTION

I am sending you this letter in order to petition for executive attention to the tragic matter of the Bolinas, California radio transmission facility of the Point Reyes National Seashore. At present, the historic Marconi Power House is crumbling and the site is suffering from the ravages of theft and the acts of vandals. Important artifacts have been lost and equipment stripped. Recently the last standing radio tower crashed to earth as a result of local kids making it an "amusement ride." Despite enforcement rangers being forewarned, the condition remains unabated. Another tower has been completely stolen, with no attempt at recovery. The situation goes even further.

I have been a principle victim in this matter and, most important, the public interest and the Park Service are victims. Therefore, this letter constitutes an official petition of grievance, and on a class action level. Your office has been selected to receive this because I believe your office would take the greatest interest in Bolinas. The technical significance of the Bolinas Radio Transmission Facility of the National Park Service (N.P.S.) needs executive acknowledgement. The historic resource study of the Point Reyes National Seashore is just now complete. I suggest that you obtain a copy. What is lacking in that study is presented in my own companion study, however this is still in its embryonic form. A copy of the draft will be sent to your office.

Due to the fact that allegations asserted in this letter constitute a criminal complaint, it is of course your responsibility as a federal officer to forward this matter to your superiors or to the proper justice department officials in the event that you are not in the position to institute action. Executive action cannot be avoided. Of course, extensive falsification can be expected on the part of the accused, so a careful investigation will be

required. I will later obtain signed and notarized testimonies as a part of my published study.

## II.) THE BOLINAS FACILITY

The Bolinas Radio Transmission Facility of the National Park Service is a most remarkable scientific and historic treasure. It is unfortunate that this cannot be appreciated by the Point Reyes National Seashore Administration, but this is understandable, as you will see. The Bolinas site, and its companion site in Marshall, originated with the efforts of Mr. Guglielmo Marconi, LL.D., Ph.D., the famous promoter of electric wave telegraphy, or "wireless," as it came to be known. Construction of the facilities began in the year of 1913 and within a year's time the developed station became one of the largest on earth. Massive aerial-ground wire arrays were put in place, covering 750,000 square feet. Thousands of square feet of metal plates were set underground and even out to sea. This network connected to a cathedral-sized power house (now called Building Number One.). The power house contained a megawatt substation and a disruptive discharge oscillator, delivering 300 kilowatts to the aerial-ground network; no larger has ever been constructed. I have discovered through various tests that with the exception of the oceanic portion, the underground network is still intact. This is an absolute treasure for the study of geo-electric phenomena, particularly because of its immediate proximity to the renowned San Andreas geological fault line. It is of interest to note that the importance of this site was such that it was taken from Marconi by the U.S. Navy in 1919. The Navy again took control in 1940.

Upon the removal of Marconi from the Bolinas site the Radio Corporation of America was formed as an outgrowth of General Electric to take on this and related facilities. Through RCA, General Electric removed the Marconi equipment and implemented the remarkable wireless system developed by its own scientists, C.P. Steinmetz and E.F.W. Alexanderson. The works of these great scientists is as important today as it was in 1919, and thus the significance of the Bolinas site. The site was to continuously expand under RCA with progressively updated General Electric equipment. Later, RCA developed its own equipment and several new structures were erected over the years: Buildings 2, 9, 2A, etc. Its culmination by 1960 was a station that transformed 1.5 million watts of electric power, delivering this to



a 3000-acre rhombic antenna array. Today, a still functional version of this exists, with a few hundred acre array and about 30 transmitters. This is waiting for a new patron, and I have located that patron.

Many significant edifices and artifacts exist at the Bolinas site. Most significant is the Marconi Power House. The foundations of the Marconi & Alexanderson aerial-ground network remain intact for the most part. Various dumpsites exist along the ocean bluffs. Contained within the Marconi Building is a remarkable transmitter (called BL-10) which is 50 feet long. It was the last to operate in that building.

All this is in need of protection by an executive agency. Examination and study by qualified individuals from the historic and scientific standpoints should begin at once. I have these qualifications. But most important is that this remarkable facility be given proper attention and be allowed to continue along in its 87-year tradition, now operating in the form of public interpretation standing with technological functioning. What must not happen is, the site must not become a dead specimen to be locked away to serve only the amusement of a self-appointed elite. The tragedy is the state of affairs as they exist today, hence this plea to your office for executive intervention.



Marconi Power House Building, current condition

### III.) E.P. DOLLARD

My personal history at the Bolinas site began with a high school special education program in the year of 1967. As a so-called "gifted student," many technological and scientific facilities were made available to me. Out of these, RCA Bolinas was where I chose to start my career in science and engineering. I felt my destiny to become the next engineer in charge after Frank Spicer. I promptly gained both professional and amateur radio licenses in my later high school years. Strong encouragement was given to me by the Bolinas crew, from manager to lineman. My good fortune was to receive possession of equipment needed for my personal laboratory and related scientific study. I put much effort into this fortunate situation.

Upon leaving the Navy, I rejoined RCA Bolinas to begin my career. However, it was such that the station was beginning to go out of business and had a dim future. The politics surrounding this condition were not favorable to prospective employees. Only one transmitter remained on the air, transmitting to a small island in the Pacific. Cutbacks in staff began and all maintenance stopped. After discussing of my research and the station situation with the regional vice-president of RCA, it was decided that the continuation of my research may provide a new life for this form of technology we call radio. All de-commissioned equipment was transferred through me into a Trust called Resource One. This group worked toward public use directed re-utilization of discarded technology. The location was in San Francisco. This equipment was to be transported by the city and county of San Francisco, to a city warehouse at Pier 3, Fort Mason. A laboratory and restoration was set up at 1360 Howard Street in the city. Research there led to a particular discovery of great promise. A new radio technology was in the making. The responsibilities bestowed upon me were being carried out with wonderful success. Then came the Commonweal.

### IV.) THE COMMONWEAL

The death of the Bolinas site can, in principle, be attributed to the Commonweal. This organization has been the lethal tumor in the station's history. In seeking the meaning of the word, we find certain definitions which apply. Webster's International Dictionary, Second Ed.:

weal (wēl) - noun



1) wealth, riches, pomp

common – adj.

1a) belonging or pertaining to the community at large, either as a social group or as a political organization; public; subject to the rights of common use; as in the common pasture; the common good; railroads are common carriers.

1b) habitual or notorious; as a common cold or thief

We may ask: How did Bolinas become inoculated with the Commonweal and its kindred elements?

In the transitional period of ownership of the RCA transmitter site from RCA to the department of the Interior, National Park Service (N.P.S.), a middle agency, appeared, calling itself Trust for Public Land (T.P.L.). The mission of T.P.L. is to implant certain of the politically elite into sites of uncommon beauty or resources. Upon completion of this phase, the land is then turned over to a public agency with the implanted elements cemented in place with “sweetheart leases.” Hence, the public agency gets stuck with the implant, that is, inoculated.

In the specific case of the RCA Bolinas facility, two political personages were implanted: Michael Lerner and Orville Schell. Lerner, a self-appointed philosopher, is the offspring of the New York elite. He also serves as Ms. Hillary Clinton’s personal guru, a position akin to Rasputin. Lerner had made his way into a federal agency. Schell is famous for his trips to China and his teachings on the subject; he has made his way into the State of California agency. Schell also published a book of his idyllic Bolinas, The Town That Fought To Save Itself. When the lease agreements were forming, Lerner claimed to be establishing a cancer research group, and Schell claimed to be establishing an organic hog farm. Needless to say, once the lifetime leases were set in place, these claims did not materialize. Lerner’s Commonweal became an organization for dissemination of political rhetoric and funding for related individuals. The late Philo Farnsworth referred to them as “grant lizards.” Schell quickly set his own people, named the Nimans, in place. Niman constructed a private home (on public land) and sublets the land in an unnoticed form to an organic cattle operation. In reality, these cattle may not be so organic as they mill about in the toxic dumpings, with full knowledge of all mentioned parties.

In the town of Bolinas, the underlings of the aforementioned principles quickly flooded the locale (1976). Various grant programs were established; many were living on trust funds. Indigenous locals were pushed aside and a major marijuana and mushroom production was established with seeming immunity from local law enforcement. In order to conceal their location this group removed all road signs directing to Bolinas. The town was now renamed "Bo-Bo," an exclusive community. The efforts of this group are reaching fruition today.

Needless to say, this had a deleterious effect upon the preservation and research program underway. Upon receiving the RCA site, the N.P.S. considered getting rid of the Commonweal and the Department of Justice was taking good notice of Bo-Bo. However, both the Weal and Bo-Bo were to continue unabated.

#### V.) THE DESTRUCTION BEGINS

What is most worthy of note was the singular viciousness of Lerner's Commonweal with regard to the efforts of preservation. In a di-polar manner Lerner, in letters to RCA, spoke of the importance of the site history and how he would have all equipment safely stored in the vacant portion of the Marconi Building. The actions proved to be in contra-distinction to the words: all mention of Marconi was removed from what they selected to restore, and what commenced was a violent destruction of all radio equipment within their reach.

The Commonweal's destructive efforts were quite remarkable in their fanatical manifestation. This effort went so far as to require the notification of the police and left one RCA employee (Ivan Neilson) in tears. We had all worked hard to protect this equipment. As each item had been prepared for transport by me, it was to become a victim of vandalous efforts during my absence, so as to make the equipment unusable. This was the work of a Mr. Burr Henemann (a proclaimed environmentalist) and Michael Rafferty (hatchet man). At the peak of the frenzy, a team of local juveniles, with state funding, were set loose upon the equipment armed with bats, axes and sledgehammers. A free-for-all ensued, reducing the station equipment to a pile of twisted metal, broken glass and toxic debris. A thousand gallons of transformer oil were improperly disposed of. Very toxic chlorinated-biphenols (PCBs), mercury, and thorium isotopes were strewn everywhere.



Some of the kids were badly contaminated. In continuation of the Commonweal efforts, every book, blueprint, or engineering report was dumpstered or scattered to locals. Now one may think this strange action for those who call themselves environmentalists; who call themselves cancer researchers; or who preach New Age ideologies of love, compassion and environmental wisdom. But anything is possible with Lerner's Commonweal.

The situation does not end here:

- 1) Recently the Commonweal's subletted vandals stole about two miles of heavy copper transmission wire off the exterior poles. Over 25 poles were also removed from the site.
- 2) The Commonweal often will cut down transmission poles, cut cables and alter piping without regard for their purpose. Water and lights have been hereby cut off to the Marconi Building, leaving it dark and without sanitary facilities.
- 3) The complete lack of care to the Marconi Building has resulted in major structural damage to its concrete exterior. Interior structures suffer from corrosion and decay. Sublets have resulted in stripped power wiring and the removal of the instruments of transmitter BL-10.
- 4) The garage structure has been allowed to partially collapse and become a center of waste oil, debris and abandoned vehicles.
- 5) Invasive plant species are allowed to spread unabated.
- 6) Of further note is the grip that the Commonweal holds on the local community. In my own life in Bolinas, I am under constant harassment by their agency, an attempt even having been made on my life. My garden and aerial site was bulldozed by induced county officials. Furthermore, in excess of 50 thousand dollars was offered to expel me from Bolinas. "We have been trying to get rid of him for a long time," touts Weal manager David Parker. Their observation of me is a violation of my civil rights.

It is my assertion that the Commonweal situation is directly analogous to the Synanon problem which existed at the Marconi Receiving Station in Marshall. The Commonweal is thus a more refined problem at the Marconi transmitting station at Bolinas (refer to David Mitchel, Point Reyes Light, and his writings on Synanon). It is my conclusion that the Commonweal be promptly evicted and/or made to pay for the extensive damage to livelihood and property. Failure to carry this out could only be regarded as nonfeasance.

#### IV.) TODAY'S SITUATION

Now that the time has come, because of the recent transfer of the physical plant to the N.P.S., for my potential entry as an advisor and site engineer, I am told that the Commonweal does not approve. I am told that I am "history," and to forget about my "pie in the sky" ideas about preservation, restoration or re-utilization. This is my reward for spending two-thirds of my life on this project and being the acknowledged sole surviving expert on the Bolinas facility. I have been offered funding for my efforts and have caught the interest of other agencies of the U.S. Government and their part in keeping the station operational. I have provided security and maintenance at my own expense, just to be asked by the Enforcement Ranger, "When are you going to bug out of here?" Yet, without my presence, the site is wide open to vandal activity. I often travel several hundred miles at my own expense to re-secure the Marconi Building so as to prevent any further damage to its contents. This trip is due again in a few weeks and I am fatigued with the confrontational attitude of the Enforcement Ranger.

Ultimately the administration of the Point Reyes National Seashore should not bear the blame for this condition. This office has put forth much effort toward preservation of the facilities, considering the funding and manpower available to them, and I have found the superiors to be very cooperative and helpful. However, for these people to go against the wishes of the Commonweal would be political suicide. The management of these facilities will take a higher or impervious power. I believe this is your task, Mr. Auer. There is ample means for the Bolinas site to regain its position as a great radio station of the world, available to public interpretation. At present, the only plan to be allowed, one which suits the Commonweal, is a limited ham radio club operating but a few hours a month. This is hardly



realistic, since the proper use of the facilities would require no less than two full-time employees or staff members. The present plan will allow for Commonwealth censorship at the Bolinas station and give them free access to station switch gear and wiring frames. It is my belief that things must go the other way, including the eviction of the Commonwealth, removal of all historically inappropriate construction, restoration of the original RCA offices, which they occupy, back into station offices, and allowance for habitation of the residential structures by station staff, if this portion be retained by the Commonwealth.

There is no shortage of qualified manpower or financial backing for any restorative or reutilization effort. The ham radio club will serve its part well in vitalizing the old KPH, but is much too limited for site management, a full-time task. As an example of potential resources available, upon my second prompting of the Marconi family, what resulted was their approaching the Point Reyes Administration with a definite plan and five million dollars backing. It is my understanding that the Marconis are hard to work with and their offer was turned down. I have interested another U.S. Government Agency in supporting an operating facility with an expected annual outlay of at least 250 thousand dollars. An FAA subcontract organization, AIR, INC., presently operates at the receiving facility and should be encouraged to partake. Any effort may be slow to start, but in a few years, these facilities could become a jewel of the National Park Service. Qualified engineers and historians need to be put in place to commence the task of study, restoration and care. I am always available for this task as this was the original mission put to me by the RCA staff, and I am acutely interested in accomplishing this mission, even today.

When the history of the great Marconi - RCA is written, will it be one with a bright future, or will it be one with a tragic death in the form of murder? You have the power to decide.

E.P. Dollard

1850 Hours U.T.C.  
19 Dec., 1999

6



IN REPLY REFER TO:

## United States Department of the Interior

NATIONAL PARK SERVICE  
P.O. Box 37127  
Washington, D.C. 20013-7127



K14(424)

23 FE

Mr. Eric P. Dollard  
P.O. Box 644  
Bolinas, CA 94924

Dear Mr. Dollard:

Thank you for your letter of December 14 regarding the Marconi communication facilities at Point Reyes. I apologize for the tardy reply.

The Point Reyes Lightboat Station is a National Historic Landmark, but the Landmark does not include the Marconi station or other areas of the Point Reyes National Seashore. I understand that Mr. Livingston at the Seashore is preparing a nomination for the Marconi station to the National Register of Historic Places. Listing on the Register will give recognition to the station's historical importance.

A new Superintendent will be taking up his duties at Pt. Reyes National Seashore in a few weeks. It would be appropriate for your group to contact him to discuss protection and possible future use of the Marconi station.

Thank you for your concern.

Sincerely,

*for* Rowland T. Bowers  
Acting Associate Director,  
Cultural Resources



# RCA Transmitting Station

## [Point Reyes National Seashore](#)

Marin County, CA



The Marconi/RCA Bolinas Transmitting Station is an approximately 422 acre designed landscape that is located on the southwestern side of the Point Reyes peninsula, around two miles northwest of the city of Bolinas on Mesa Road. Located on mostly level terrain at an elevation of roughly 180 feet above sea level, the property historically associated with the station extends from Mesa Road southwest to the Pacific shore with grazing pastures to the north and south.

The area for the transmitting station was selected because of its level, low vegetation, elevated topography and its isolated location away from natural and man made atmospheric signals that could have interfered with transmission. The historic district is comprised of improvements dating from the Marconi and RCA eras, including the majority of the buildings and structures.

The RCA/Marconi Bolinas Transmitting Station is within the Marconi/RCA Bolinas Transmitting Station and RCA Point Reyes Receiving Station Historic District that is eligible for the National Register of Historic Places. The Transmitting Station is significant at a national level under Criteria A and C with a period of significance from 1913 to 1973. Under Criterion A, the district is significant for being the location of events that have greatly contributed to the development of early wireless communications systems throughout the country. Under Criterion C, the district is significant for its highly designed Mission Revival buildings from the Marconi era and Art Deco buildings that date from the RCA era.

The period of significance covers over half a century, beginning with the initial Marconi Corporation development of the Transmitting Station in 1913 and extending to 1973 when point to point radio service was discontinued due to advances in satellite based communications. This period encompasses the major development of the roads, buildings, structures, antenna fields, and fence lines within the station property.

The Marconi/RCA Bolinas Transmitting Station operated without interruption as a radio transmitting station for over sixty years until its purchase by the National Park Service in 1979. It appears today much as it did during the period of significance and retains its historical integrity of location, design, setting, materials, workmanship, feeling and association. The Transmitting Station complex contains fourteen historic buildings and structures, organized in three clusters on the property. Contributing resources include the Antenna Field, Marconi Transmitter Building, Marconi Hotel, Marconi Cottage 1, Marconi Cottage 2, Marconi Tennis Court, Marconi Pedestrian Bridge, RCA Transmitter Building, RCA Garage, RCA Switching Building, RCA Cooling Tower Foundation/Reservoirs, Marconi Cooling Tower Foundation, RCA Tuning Building, RCA Generator Building, and Historic Road Network. Non contributing resources include the Commonweal Meditation Hut, Commonweal Pump House, and Commonweal Sauna.

The historic character of the Marconi/RCA Bolinas Transmitting Station is still evident in the following landscape characteristics: natural systems and features, spatial organization, land use, buildings and structures, small scale features, circulation, vegetation, and archeological sites. Based on the evaluation of these characteristics, the cultural landscape at the Transmitting Station exhibits key patterns, relationships, and features that convey the historical significance of the station.

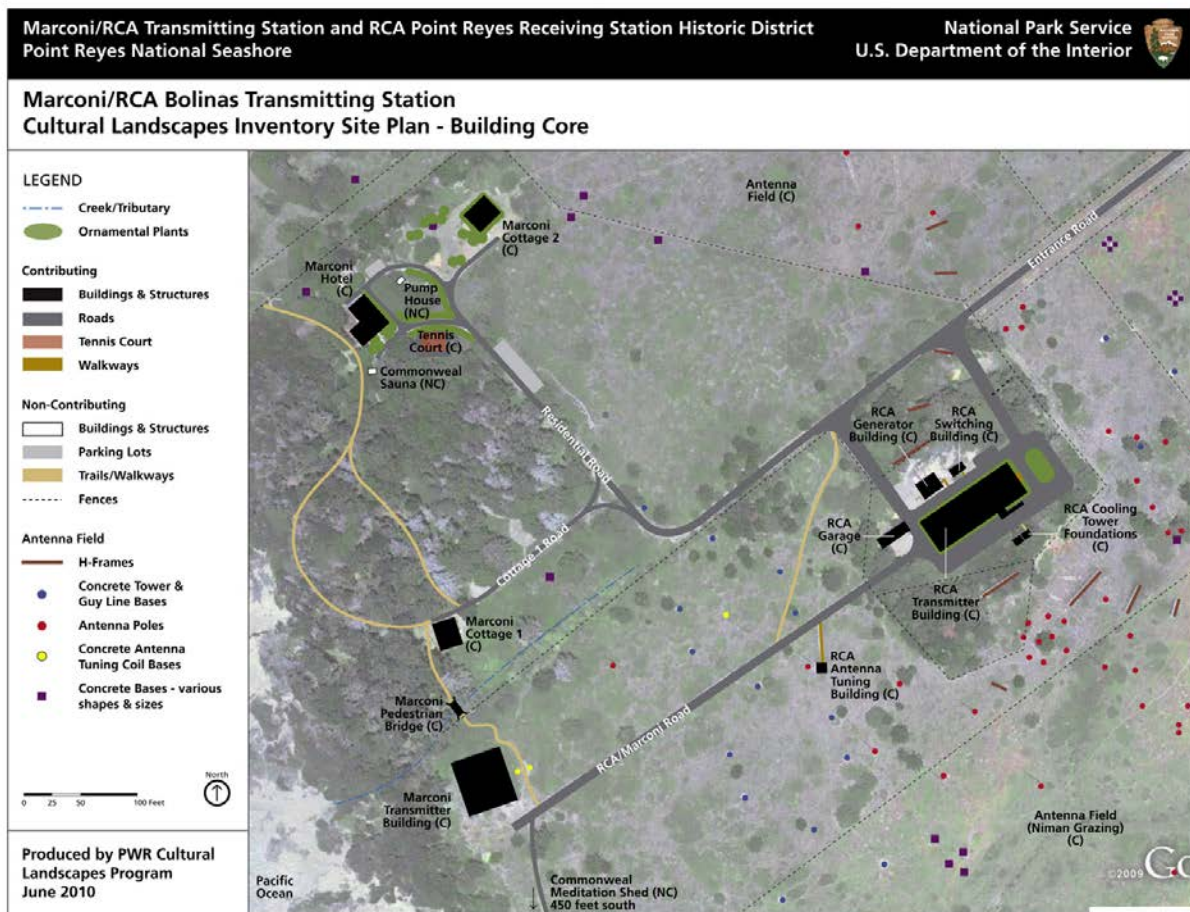



E.P. Dollard  
American Marconi  
Bolinas, CA  
1450 UTC, Sept. 4, 2001

G. Norton, Director  
U.S. Dept. of Interior  
Wash., D.C.

Dear Ms. Norton,

I am writing your office regarding the matter of the Marconi/R.C.A. Radio facilities within the point Reyes National Scashore. Enclosed is a copy of my letter sent to M. Auer of your organization. Upon receipt of that letter, R. Minichiello of the Marconi Foundation recommended that your office be advised of the situation.

The condition at these radio facilities has become so severe that civil as well as criminal lawsuits are being considered. Also, the possibility of citizen arrests are being studied. While such actions are effective from the punitive standpoint, ultimately they would be an admission of failure in bringing the radio facilities back to life. I pray that your office can correct this condition.

What follows is an overview of the situation at the Bolinas site:

- a) For over a year I have pointed out that a particular utility pole could smash across the N.P.S. public parking lot at the Bolinas (BL) site. Recently the pole began to give way in this direction. Point Reyes officials ignored my warnings and became rather hostile. I promptly contacted the Marin County District (4) supervisor's office, the local fire chief and the local Coast Guard chief. The local officials confirmed my observation and reported to the District 4 office. N.P.S. officials continued to claim my observation to be a falsification. Finally the press entered and the pole was taken down. If I had not acted, someone very likely would have been killed.
- b) In my regular patrol of BL site security, I located a quantity of the environmental toxin, Chlorinated Bi-Phenol (approximately one pint) within the area that the commonweal rents to the public (a lease violation). The same local officials were again contacted and again my claims were verified. Pt. Reyes officials responded in the exact same manner, this time removing evidence of the toxin, but leaving the same in the soil (at a public location). Pt. Reyes then claimed that I put the toxins at that location and launched a harassment program against me. This of course obviates legal actions upon N.P.S. officials.
- c) Your tenant, the Commonweal, is affiliated with individuals in the town of Bolinas that openly sells Herion with impunity, breaks up families in order to get their children into programs from which they derive financial gain, engage in child

prostitution, and make payoffs to N.P.S. and local officials so as to rid themselves of "problem individuals" such as myself.

- d) A fraudulent historic society, related to the Perham Foundation, an organization notorious for mishandling and profiting from historic material, is now removing important material from the radio facilities. Organizations such as the U.S. Coast Guard, or Marconi Foundation are blocked from site preservation and operation. This activity is directed from the Golden Gate National Recreation area which has no business at Pt. Reyes or Bolinas.

In conclusion, I cannot believe that any of these activities are in the best interest of the U.S. government, nor can I believe that the present (Bush) administration knowingly operated in this condition. These activities are more in accord with the previous (Clinton) administration.

I eagerly await a timely response from your office. Thank you for your cooperation.

Eric P. Dollard  
Darcell Electronics  
4910 St. Anita Ave.  
El Monte, CA 91731



Marconi Building One. Interior view on March 7, 2007.





**RADIO AFICIONADO** Eric Dollard of Bolinas claims Commonweal has allowed this facility from the early days of radio to be vandalized. Commonweal leases the property from the Point Reyes National Seashore, and Dollard acknowledges having had run-ins with both organizations as he pressured them to protect this onetime Marconi Radio Transmission Site in Bolinas. Not only is West Marin's key role in the development of radio being destroyed, Dollard claims, the facility has become a hazard. (Light photo by Gregory Foley)

## Accusing Commonweal of allowing radio site to be destroyed

By Eric P. Dollard  
Bolinas

I am writing this column to make known the very grievous situation existing at the Marconi Radio Transmission Site at Bolinas. The site is now within the boundary of the Point Reyes National Seashore and has become a public hazard: its historic and scientific significance is compromised. The public interest is the principal victim, but this columnist has also suffered greatly in this matter.

It is little known that the Bolinas site has played a sig-

nificant role in the development of electricity. Lesser known is the advanced technology latent in this site, a technology that could eliminate the consumption of fuel for the production of electricity.

The transmission site was begun by Guglielmo Marconi, the famous promoter and developer of *electrostatic wave telegraphy* (to become known as "the Wireless"). The site was by far one of the most advanced facilities of its era. Construction began in 1913, and in a year's time, it became one of the largest radio-frequency power plants on earth.

### **'An electrical Stonehenge'**

Its aerial-ground structure covered 750,000 square feet of land, and 500,000 watts of electrical energy was drawn from PG&E, bringing power to Stinson Beach and Bolinas from Alto. An electrical activity of 175,000 horsepower surged in the massive, earthed aerial at the rate of 2,700,000 revolutions per minute. It is most remarkable that the underground portion of the earthed aerial is mostly intact today. It can be said that the transmission site is an electrical Stonehenge.

Marconi was removed from the site by the US government at the onset of World War I, the Navy took control of the transmission site during the war, turning to the General Electric Company for engineering. GE removed the Marconi equipment and by 1919 installed its own Alexanderson System. This system was so advanced, even by today's standards, that the Navy insisted it never fall into foreign hands, such as Marconi. The Bolinas site was the most advanced of the Alexanderson installations with regard to its



aerial-ground structure. It is still of scientific interest.

By 1920, the US Navy organized the formation of the Radio Corporation of America (RCA) to take control of the transmission site and related facilities. RCA removed the Alexanderson gear in the early 1920s, replacing it with its own system of short electro-magnetic waves (shortwave). This has become the radio of today.

Electrostatic wireless was to become forgotten, and contemporary atomic science would declare electromagnetism the only possible electrical transmission mode, a grave setback for electric science and engineering.

At the end of its life in 1974, RCA in charge of the transmission site, worked with this columnist to develop a plan to protect the remaining equipment and records. A protective trust and research laboratory were established to facilitate this effort. Progress was slow but steady. Then came Commonweal, the lethal tumor in the Bolinas site's history.

"What is Commonweal, anyway?" this columnist is repeatedly asked. No one seems to know. By dictionary definition: "weal (wēl), *noun*; wealth, riches, pomp."

The salient feature of Commonweal was (and still is) the singular viciousness it displayed toward the facility, its crew, and the effort to preserve the site. Twenty-six years garbage, toxics, and wrecked equipment remain. Commonweal continues unabated and with total impunity. Commonweal history follows:

- **Upon entry to the Bolinas site**, hires juveniles armed with hammers, axes, and bats to smash everything

within their reach.

- **Toxic thorium, mercury, beryllium oxide, PCBs, and oils** were strewn everywhere in a grand free-for-all.

- **Historic records, notes, books** are dumpstered or scattered.

- **Equipment is dumped** in pits or thrown into a local creekbed.

- **Cables, pipes, or related structures** are altered, removed, or replaced without regard to safety codes, fire safety, or historical significance.

- **Toxic debris remains exposed** along cliffs  
(Please turn to Page 12)

Point Reyes Light, November 16, 2000 — 11

## Guest Column

### Accusing Commonwealth of allowing radio site to be destroyed

By Eric P. Dollard of Bolinas

While writing this column, I received several distressing e-mails from the Marin County Common-wealth in Bolinas. The e-mails contain the "Journal" of the Point Reyes National Seashore and has become a public hazard, an historical and scientific significance is compromised. The public interest is the pragmatic victim but this columnist has also suffered greatly in this matter.

It is little known that the Bolinas site has proved a significant site in the development of electronics. Lesser known is the advanced technology latent in this site a technology that could eliminate the consumption of fuel for the production of electricity.

The transmission site was begun by Guglielmo Marconi, the famous promoter and developer of radio. It was telegraphically to become known as "the Wireless". The site was by far one of the most advanced facilities of its era. Construction began in 1913 and in a year or more it became one of the largest radio frequency power plants on earth.

#### "An electrical Stenobunge"

In a highly novel structure of only 7,000 square feet of land, and 500,000 watts of electrical energy, the Bolinas PG&E, bringing power to the Marin County and Bolinas from Alton. An electrical industry of 175 kilohertz power was used in the massive, earthed aerial at the rate of 2,200,000 revolutions per minute. It is most remarkable that the underground portion of the buried aerial is mostly intact today. It can be said that the transmission site is an electrical Stenobunge.

Marconi was removed from the site by the US government at the onset of World War I. The Navy took control of the transmission site during the war, using the General Electric Company for engineering. GE removed the Marconi equipment and the Navy installed its own Alexander-son System. This system was also a radio frequency system, that the Navy insisted it never fall into foreign hands, such as Moscow. The Bolinas site was the most advanced of the Alexander-son installations with regard to its electrical system, in the world of scientific interest.

In 1929, the US Navy transferred the operation of the Radio Corporation of America (RCA) to take control of the transmission site and related facilities. RCA removed the Alexander-son gear in the early 1920s, replacing it with its own system of short electro-magnetic waves



**RADIO AFICIONADO** Eric Dollard of Bolinas claims Commonwealth has allowed this facility from the early days of radio to be vandallized. Commonwealth leaves the property from the Point Reyes National Seashore, and Dollard acknowledges having had rumors with both organizations as he pressured them to protect this outtime-5,000-ton Radio Transmission Site in Bolinas. Not only is West Marin's key role in the development of radio being destroyed, Dollard claims, the facility has become a hazard. (Light photo by Gregors Foley)

temporarily atomic science would create electricity from the only possible electrical transmission mode, a power setback for electric science and engineering.

At the end of its life in 1974, RCA in charge of the transmission site, worked with the Commonwealth to develop a plan to protect its remaining equipment and records. A project to take the remaining equipment was established to facilitate this effort. Progress was slow but steady. This came Commonwealth, the total tensor in the Bolinas site's history.

"What is Commonwealth, anyway?" this columnist is repeatedly asked. No one seems to know. It is obviously delusion, local truth, mass, middle, riches, power.

The claim that the Commonwealth was a yardstick in the singular measures it displayed toward the facility, its crew, and the effort to preserve the site. Twenty-six years

garbage, toxics, and wrecked equipment remain. Commonwealth continues unabated and with total impunity. Commonwealth history follows.

- Upon entry to the Bolinas site, hines juveniles armed with hammers, axes, and bats to smash everything within their reach.

- Toxic thorium, mercury, beryllium-oxide, PCBs, and oils were strewn everywhere in a grand free-for-all.

- Historic records, notes, books are dumpstered or scattered.

- Equipment is dumped in pits or thrown into a local creekbed.

- Cables, pipes, or related structures are altered, removed, or replaced without regard to safety codes, fire safety, or historical significance.



# Radio facility...

(Continued from Page 11)

grazed by cattle and walked by the public — 20 years after notification.

Why does the Point Reyes National Seashore or the GGNRA allow this to continue while these organizations are evicting all other leaseholders within their realm?

## Antenna poised to fall

The phenomenon that gave rise to this writing is that an 85-foot utility pole, 1,000 pounds of it, sits poised to crash across the public parking lot at the transmission site. The pole is held up by a single, rotten guy wire.

The National Seashore's response has been to harass this columnist [for making an issue about the deteriorating radio site] and to ignore the pole. Is this criminal? Bolinas Fire Department and the Sheriff's Office seem to be helpless in this matter. What is going on here at the Bolinas site?

To further compound the disaster, the Maritime Radio Historical Society is altering and removing equipment without executive oversight, further damaging the Bolinas facility. *The Light's* glowing report [July 20] on the Maritime Radio Historical Society [making a memorial KPH broadcast July 12] is not the reality of what is happening.

In conclusion, I must ask how this could happen in a town like Bolinas, which prides itself with such high ideals. Will the transmission site be allowed to disappear? If so, it will be a great loss to mankind.

*Editor's note: By his account, guest columnist Dollard began working at the RCA site in 1967 as part of a special program for gifted high school students. Encouraged by the crew there, he earned his amateur and professional radio licenses. After naval service, he rejoined the RCA crew in Bolinas just as RCA was beginning to phase out the station.*

## PacificSun Interview

# Curing a planet

Michael Lerner explains  
the global health movement  
he researches and nurtures

JILL KRAMER

Unlike Abbie Hoffman, Michael Lerner doesn't urge people to steal his book. He gives it away. He's put the entire text of his widely acclaimed page *Choices in Healing* on his Web site. It probably is his publisher, MIT Press, crazy. But it says a lot about who Lerner is. While Hoffman displayed his pop culture in a great show of iconoclasm, Lerner's style is the epitome of understatement. He doesn't tell anybody he's giving his book away, he just does it. And he has no intention of breaking society's rules. He just wants to help make the world a better place.

Lerner orchestrates a number of world-healing projects under one roof, the nonprofit institute Commonweal, which he cofounded in 1976. It all started with the institute's children's program. Originally from New York, Lerner had come to California on sabbatical from Yale, where he had been researching child development issues at the Carnegie Council on Children. But when he met ecologist Carolyn Brown out here, he decided to stay and help her found Full Circle, a residential school for troubled children in Bolinas. Wanting to explore the link between learning disabilities and environmental factors, Lerner hooked up with environmental consultant Burr Manin a few years later and formed Commonweal. The institute is a site they chose once desolate piece of land abandoned by the Redwood Communications center, perched on a cliffside in Bolinas.

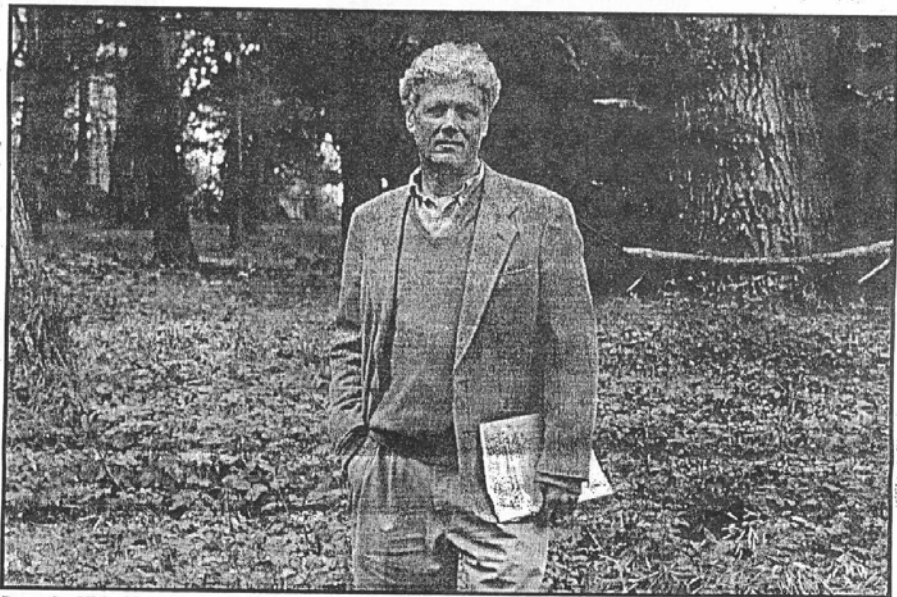

Dennis Breau

Researcher Michael Lerner cofounded the nonprofit institute Commonweal in 1976 and still develops world-healing projects there.

spawned new projects in those fields, Lerner turned his attention to disease prevention. Convinced that the mental and physical health of individuals is linked to the health of the planet, he launched a series of environmental projects. Again, he pulled together the talents of a handful of brilliant

who have had documented spontaneous remissions, so I know that they are real. But for me, spontaneous remissions are simply the tail end of a distribution curve of outcomes for life-threatening cancer. So what one or more commonly are people who have lived for 40 years



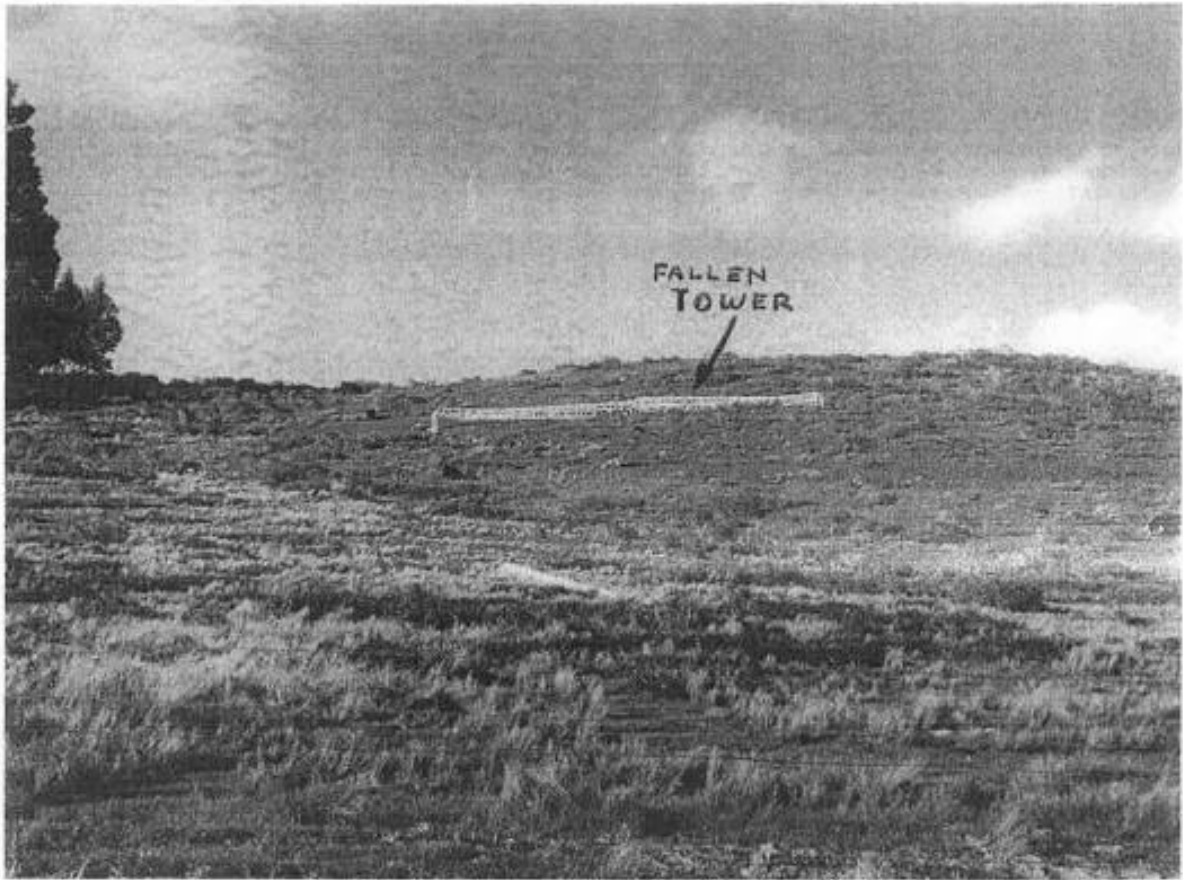

Bolinas Site: Fallen Tower

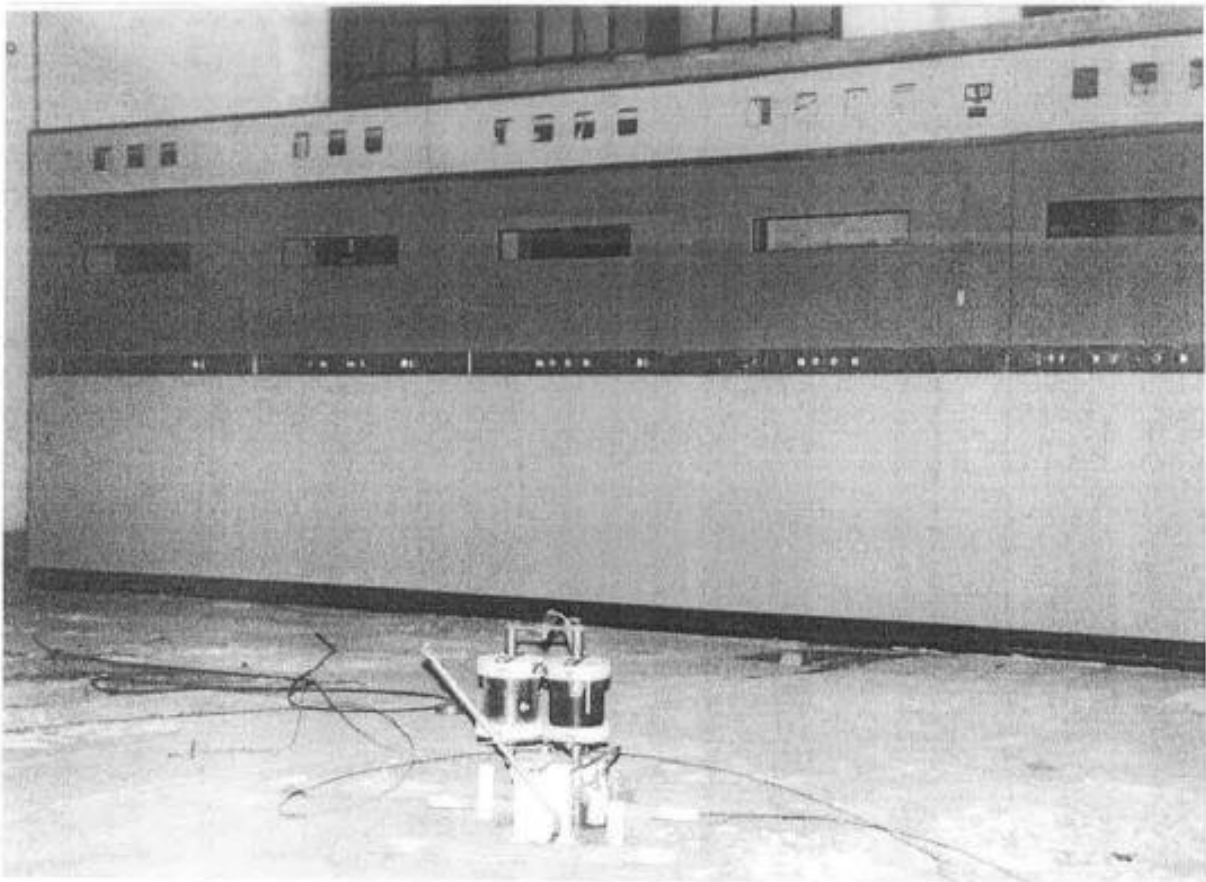

Bolinas Site: Transmitter BL-10 vandalized



Marconi Dump (view downhill to beach)

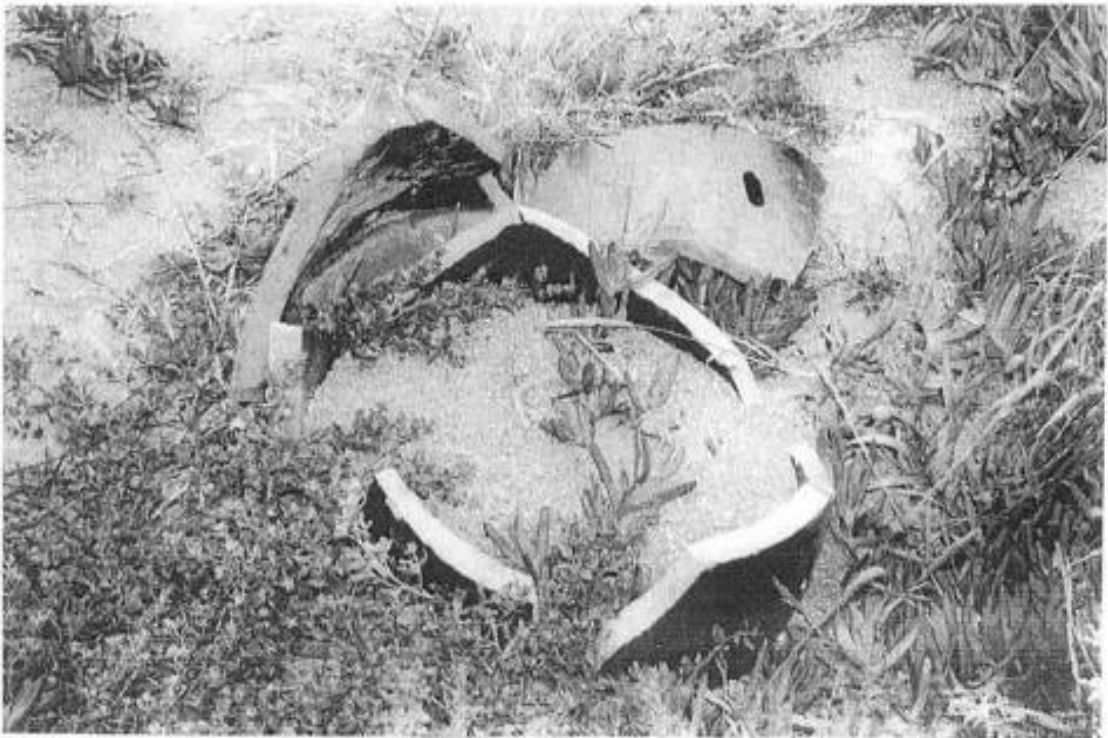

Marconi coil breakage on parkland surface





Hiking path leading across toxic transmitter dump site



Abandoned steel guy cables (hazardous to life and limb)



Mercury-toxic radio tube (model 872A rectifier) found in dump



1928 condenser unit (originally was oil-filled) left in Marconi dump



# Letters to the Editor

## Not Commonweal's fault

To the Editor:

This letter is regarding the Nov. 16 guest column which accused Commonweal of allowing the RCA radio site [in Bolinas] to be destroyed. I do admire Mr. [Eric] Dollard's passionate commitment to preservation and knowledge of the site, which represents evolving human innovation.

However, I believe his rage against Commonweal is unfair and feels threatening.

I witnessed quite a bit of the process of transforming the buildings when Commonweal first took over the site. I heard long phone conversations when Michael and Steve Lerner appealed to the Smithsonian, RCA, and other institutions to take the massive equipment from the buildings and preserve them for historic value.

I clearly remember the frustration of those who finally had to decide to break up and dismantle the equipment. I also know that many experts were brought in to help with correct disposal and cleanup of the

site.

Commonweal is an organization dedicated to cleaning up the environment! Their work is recognized locally, nationally, and internationally. I also know many people from our community who are part of the Commonweal organization, and I have to say they are extraordinary in their intelligence, integrity, gentleness, and compassion.

They are dedicated to healing people and the environment. Mistakes may have been made, but these people are *not* the enemy.

Perhaps the fault lies with RCA or the Coast Guard or the park or the general public for not having the foresight to value and preserve representative parts of this site. I wonder what happened to the historic Anderson equipment when RCA took over and the Marconi equipment when GE took over?

Mr. Dollard is angry because he understands the scientific significance of this site and its history, which is largely unrecognized or appreciated by the rest of us.

Perhaps there is a way to bring people together, and as a diversion, to highlight and preserve this rich electrical and radio history.

Elia Haworth  
Bolinas



Guy-wire insulator (from original Marconi Mast) found by author Dollard.



Portion of eight-foot long Triatic Insulator (Marconi period) found in dump



## Commonweal responds to guest column

To the Editor:

A guest column in *The Light* on November 16 contained numerous inaccurate statements about Commonweal. Since debating the author would be unproductive, we would simply like to extend a welcome to anyone who has concerns as a result of reading the column and would like to know the facts about Commonweal.

For readers who do not already know of our work, Commonweal is a health and environmental-research institute with three primary areas of interest: children, health and the environment. For the past 25 years, a community of Bolinas, West Marin and other Marin residents have worked together at Commonweal to be of whatever service we can be.

Our work with cancer patients and health professionals is nationally recognized. Our work with at-risk children has a strong statewide reputation. Our environmental programs have made major contributions to California state ocean policy reform, an international initiative to end dioxin and mercury contamination in the healthcare industry, and an international treaty to ban 12 of the most toxic persistent organic pollutants.

Commonweal also hosts a wide variety of programs open to the public that addresses health, the environment, education, the arts and other public concerns.

We warmly invite all those who would like to learn more about our work to visit Commonweal. We are also happy to respond specifically to any concerns you may have as a result of the guest column in *The Light*.

Please visit our website at [www.commonweal.org](http://www.commonweal.org) or call so that we can schedule time to show you the Commonweal site and answer your questions. You can email us at [commonweal@aol.com](mailto:commonweal@aol.com), call us at 868-0970, or write us at Box 316, Bolinas, CA 94924.

Michael Lerner  
President, Commonweal

*Editor's note: Eric Dollard's guest column on Nov. 16 accused Commonweal of allowing antique radio equipment in the old RCA building to be ruined. Commonweal uses part of the building for storage; the organization also leases more than 15 buildings near Bolinas from the Point Reyes National Seashore. Dollard's column did not deal with Commonweal's work.*

*...and other national problems. Instead, he wrote that "what gave rise to this [column] is that an 85-foot utility pole, 1,000 pounds of it, sits poised to crash across the parking lot at the transmission site. The pole is held up by a single, rotten guy wire." He also complained that "toxic debris remains exposed along cliffs grazed by cattle and walked by the public..." On Monday, National Supt. Don Neubacher told *The Light* that after Dollard's guest column was published, a search for the debris turned up half a sack full, which was disposed of in a hazardous-waste container. He said much of the transmitter debris was dumped by RCA in the 1920s and 30s, and heavy storms periodically uncover some of it. Neubacher also said that between the time that Dollard wrote his column and when it was published, the utility pole was removed. He acknowledged there is PCB contamination from radio transmitters in the building and in the transmitter debris along the cliff; however, he added, plastic fencing has been added to keep cattle away from the debris. Neubacher said the Park Service this year repaired the roof and made the rest of the building structurally sound. However, he added, the building is close to an eroding bluff, so the Park Service is still determining how much it wants to spend on a structure that may soon fall over a cliff. In any case, he added, General Electric (the successor to RCA) has "accepted all responsibility" for cleaning up lingering toxic contamination at the site and will do so under the supervision of the Environmental Protection Agency.*

## Potential toxics removed

To the Editor:

*Editor's note: This letter was originally sent to Bolinas Fire Chief Kevin Hicks on Nov. 28 and forwarded to The Light by a third party.*

Thank you for meeting with our chief of maintenance Larry Harris on Nov. 20 to discuss the possible hazardous materials that Mr. Eric Dollard located at the Commonwealth site.

Mr. Harris has advised me that he collected a number of miscellaneous electrical items, including the small component transformer from the site. All the items have been properly labeled, inventoried, and stored in our Primary Hazardous Waste Storage Facility, awaiting the appropriate disposal.

Please do not hesitate to contact us if any additional items or concerns about the Commonwealth site are brought to your attention, particularly if they may be related to possible hazardous materials that may be found at the site.

Again, thank you for taking the time to ensure that these potentially hazardous materials were properly collected and stored for disposal.

Don Neubacher, Superintendent  
Point Reyes National Seashore



GIORGIO IACUZZO

Consultant

P.O. Box 143

I-33100 UDINE

Italy

Tel. xx39 - (0)432 - 43.341

Fax. xx39 - (0)432 - 44.917

---

to:

Mr. ERIC DOLLARD

P.O. Box 644

Bolinas CA 94924

U.S.A.

Udine, dec. 31st 1993

Rif. 326

Dear Mr. Dollard,

I hope you well, I was reading in the last Borderland issue about your initiative for the Guglielmo Marconi laboratory in Bolinas, it is a very important task you are trying to do.

I would like to ask you if in the next months I will pass from California will be possible to make an interview to you about this program.

In my opinion can be important that also the italian science and technology press will describe your efforts to keep alive the memory on this italian genius.

Many years ago I was involved in trying to convince the italian authorities to restore the Elettra, Marconi's laboratory boat, but without any succes was like talking with a wall.

I wish you to find more clever support.

Another thing I like to ask you is about the noble gas engine, there are many years that I dont have any news about this your commercial application, what appned?

I am very interested to make some articles also od this machine, if still available, please if do you have some data and pictures I will thank you a lot.

For the moment it's all, I thank you very much for the attention and I wish a happy new year.

Sincerely yours

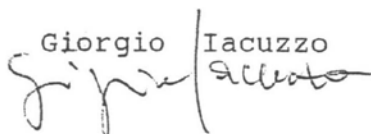
Giorgio Iacuzzo  

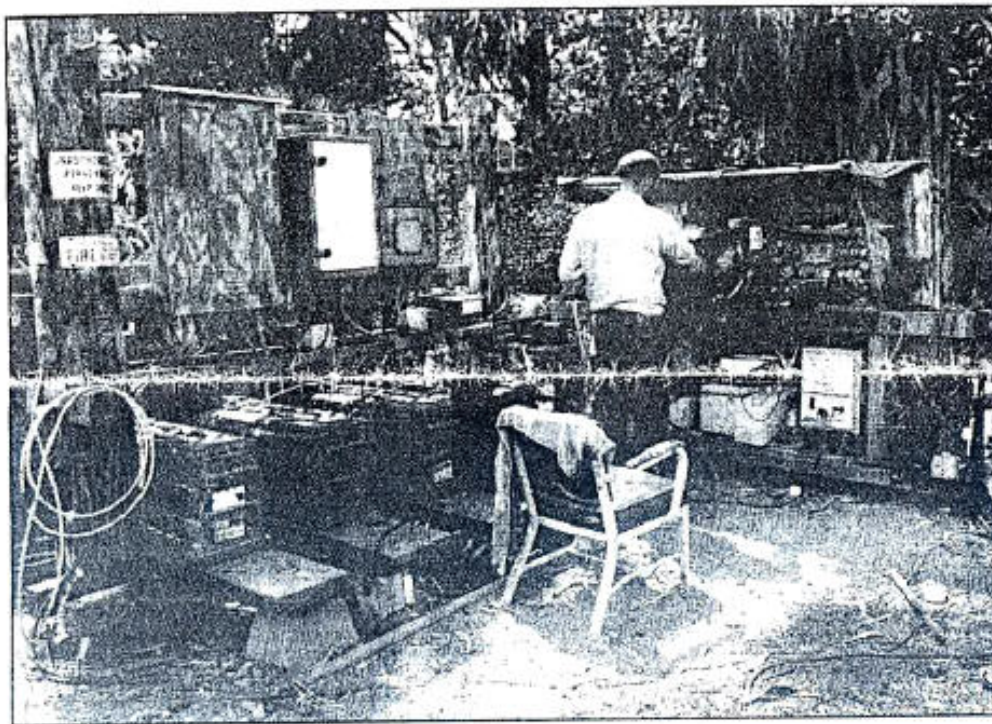
**PULSE ON  
THE WORLD:**

Eric Dollard tunes in faraway stations Wednesday on his collection of radio equipment in an open field in Bolinas

By photo/Martin E. Klimek

## Bolinas radio buff tunes in the world

By Betty Dietz

Independent Journal reporter

An eccentric Bolinas electronics buff has erected a radio receiving station in an open field so he can tune in police and cellular phone calls, broadcasts of live traffic, weather reports and other signals from across the world.

Eric Dollard calls his maze of antennas and radio receivers a "1 million (frequency) radio channel."

"Whatever you want to hear, this is the place to hear it."

Dollard and two friends staff the 24-hour alfresco lab on land owned by an acquaintance, listening to broadcasts from around the world.

While officials say Dollard's encampment is harmless, neighbors have complained about noise — especially in the early morning hours.

"We go out and ask them to turn it down. They comply. We leave," said sheriff's deputy Richard Shelden. "Two weeks or a month later, we get the same complaint. We're trying to get him to be a better neighbor. He's very devoted to his profession or vocation."

Placed around the camp are several car seats, a purple sofa, a wooden cabinet built between trees, and a hut to shelter some of the equipment from the elements. It's equipped with an electrical outlet, four large military batteries and a telephone.

Tomatoes and pumpkins sprout under one aerial.

Recently, Dollard sat on a car seat perched atop a plastic crate in front of a shortwave radio. Alternately twisting knobs and sipping black cherry kefir from a quart container, he listened to squeaks coming over the waves.

"The hurricane report comes in at 10 after," Dollard said. "At 18 after it gives conditions all over the world."

In a rapid-fire monologue, he talks about designing an antenna that could tap into the San Andreas Fault to pull in messages. And he'd like to listen to a mystery "Russian woodpecker" signal that hit the airwaves in the 1970s.

Dollard said he sometimes uses the valve handles on Alpine Dam or the fire hydrant at the end of Wharf Road to receive radio signals.

"The hydrant is really hot," Dollard said. "I just clip onto it and I can hear

China and Japan. They come booming in like a local radio station."

Bolinas officials say Dollard is, well, one of a kind.

"He's kind of an out-there character, but he's a genius when it comes to radios," said Don Rothstein, a Bolinas firefighter.

Dollard stays with friends or lives in his blue Toyota Corolla. Over the years, he has worked at the Richmond shipyards and done research at Sonoma State University and the old RCA radio station in West Marin.

He picks up odd jobs in exchange for food or money to expand his radio collection.

He talks about becoming part of the county's emergency communication system, but that's not his prime goal.

"I do this because it's my interest," Dollard said. "I'm not looking for a practical value."

Dollard's love affair with electronics started as a child in Novato. His grandfather worked for Pacific Gas and Electric Co., and his grandmother assembled radio tubes for RCA. As a teen-ager, he hung around Novato television repair shops.



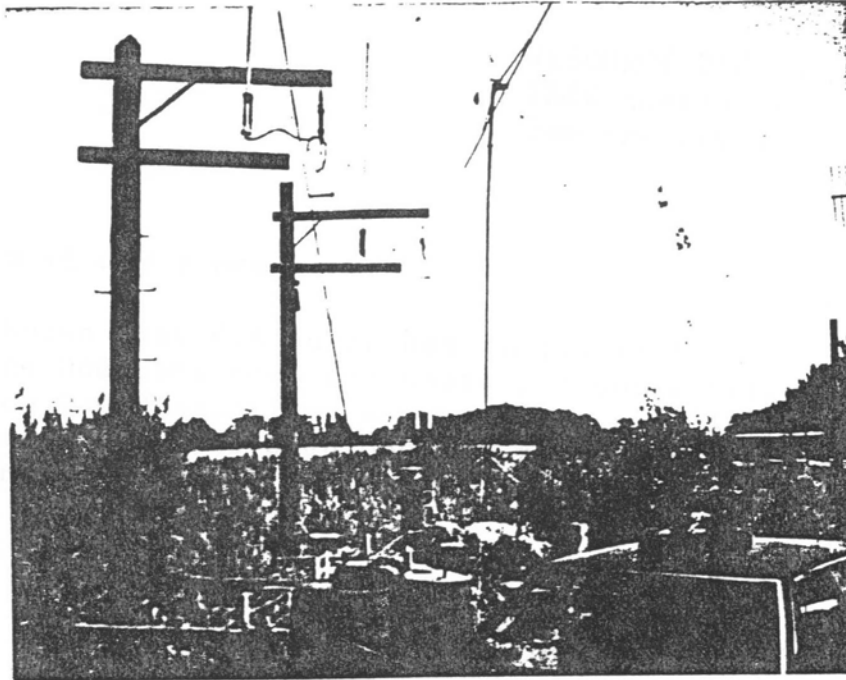

AUTHORS EXPERIMENTAL  
WIRELESS ANTENNAE BASED  
UPON TESLA PATENTS & MAINLY  
MARCONI PATENT N° 676,332  
LATER DESTROYED UPON INSISTANCE  
OF U.S. PARK RANGERS SANSING  
& EICKENHORST, BY COUNTY OF MARIN POLICE

LOCATION NEAR BOLINAS STATION  
ON PRIVATE LOT 1993 - 1995

TRANSMISSION RANGE 8000 MILES

RESOURCE ONE INC  
1360 Howard St  
San Francisco, Ca 94103

To Whom it may concern:

Be it known that RCA Corp. has no liability for Resource One personnel and those persons assisting Resource One dismantling and removing communication equipment which has been donated to Resource One by RCA Corp.

Mark Peacock

Secretary

KET SALLAGE  
OPERATION BY  
AUTHOR

MOST OF THIS EQUIPMENT  
WAS DESTROYED BY THE  
COMMONWEAL GROUP



# RESOURCE ONE, inc.

1380 HOWARD ST. SAN FRANCISCO, CA 94103 864-8663  
a community computer service

Bldg #2 list continued

Equipment -----	Serial -----	Value -----
<i>2B</i> <del>AIR COMPRESSOR</del> #		\$350
<del>BELT DRIVE LATHE</del> #		\$750
<del>FIRE EXTINGUISHER</del> <i>6A</i> #	38-1	\$150

\* NOTE 1: THE MAJORITY OF THESE UNITS  
ARE NO LONGER IN SERVICE,  
BUT A FEW ARE STILL OPERATIONAL.

# NOTE 2 ADDITIONS TO PREVIOUS LISTING.

TOTAL WITHOUT ADDITIONS: 18,075 DOLLARS  
TOTAL WITH ADDITIONS: 19,320 DOLLARS

△ NOTE 3 (CONTEMPORARY)  
DESTROYED BY COMMONWEAL

# RESOURCE ONE, inc.

1380 HOWARD ST. SAN FRANCISCO, CA 94103 864-8663  
 a community computer service

Listing of equipment desired from bldg #2

Equipment	Serial	Value	
XMTR 155U Δ	3	\$5,000	
XMTR 156U Δ	2	\$5,000	
XMTR 30EB Δ	-	\$1,000	
XMTR 33EC Δ	-	\$1,000	
XMTR 32ED	-	\$1,000	
"U" SET COOLING SYS. Δ	-	\$600	
POWER WIRING TO-DIST. PANEL (ALCOVE) FOR ABOVE EQUIPMENT	-	\$500	
TMC MODEL "VOX-5" VFO	573	\$500	REMOVED 11 JAN 75
RCA FSK/RADIOPHOTO TSC	TL-48-1	\$25	18 JAN 75
TELETYPE CORP. M-15 TELETYPE	* 7/14/75	\$25	
TELETYPE CORP. M-15 TELETYPE	* ✓ ✓	\$25	
RCA BA-6A LIMITING AMPLIFIER	2541	\$100	18 JAN 75
"	2552	"	18 JAN 75
"	25292	"	18 JAN 75
RCA BA-6A LIMITING AMPLIFIER	*	"	
ALL SPARE PARTS AND TUBES NOT REQUIRED AS SPARES FOR ACTIVE EQUIPMENT	-	\$3,000	



# RESOURCE ONE, inc.

1380 HOWARD ST. SAN FRANCISCO, CA 94103 864-8663  
a community computer service

1 Aug. 75

RCA Global Communications, Inc.  
135 Market Street  
San Francisco, Ca. 94105

Dear Sirs;

The following is a listing of the Navy surplus receivers in which Resource One has an interest.

DESCRIPTION	SERIAL #	VALUE
RCVR, MODEL RCP	RL-47	\$1,000
" "	RL53	\$1,000
" "	RM-45	\$1,000
" "	RM-46	\$1,000
" "	RM-85	\$1,000
" "	RN-45	\$1,000
" "	RS-47	\$1,000
" "	RS-48	\$1,000
" "	RS-50	\$1,000
" "	RS-52	\$1,000
FSK UNIT	<del>RN-47-28</del>	<del>\$100</del>
" "	RN-45-9	\$100
" "	<del>BR-58-65</del>	\$100
" "	LR-51-44	\$100
SUPPORTING HARDWARE FOR MODEL RCP RCVRs	N/A	\$1,000
		TOTAL \$11,400

N/R



ERIC P DOLLARD

A handwritten signature in cursive script that reads "Eric P. Dollard".

# *PART TWO*

## Physical and Historical Reconstruction of the Bolinas Electrostatic Wireless Aerial-Ground Structure

Section 1)	Historical Sequence	Page 223
Section 2)	The Initial Layout	Page 224
Section 3)	Marconi Aerial Dimensions	Page 226
Section 4)	Aerial Electric Dimensions	Page 227
Section 5)	The Alexanderson Layout	Page 229
Section 6)	Additional Structures	Page 230
Section 7)	Ground Structure Details	Page 231
Section 8)	First Section Compensator	Page 232
Section 9)	Second Section Compensator	Page 233
Section 10)	End or Third Section Compensator	Page 234
Section 11)	Compensator Details Input Section	Page 235
Section 12)	Third Phase Development	Page 236
Section 13)	Fourth Phase Development	Page 237
Section 14)	Location of Artifacts	Page 237
Section 15)	Photos, Illustrations, and Articles	Page 238



### 1) Historical Sequence:

Before the advent of the electromagnetic radio in the mid-twenties and its application to the Bolinas site through the A, B, C & D wave projectors and their related BB, EC, ED & F pliotron transmitting set, a forgotten pre-historic period existed. The principles of this period were Guglielmo Marconi, Ernst Alexanderson and the U.S. Navy. A possible future fourth phase may yet occur, thus:

- |   |           |
|---|-----------|
| a) The creation phase of Marconi        | 1913-1918 |
| b) The evolution phase of Alexanderson  | 1919-1924 |
| c) The resurrective phase of the U.S.N. | 1940-1944 |
| d) The revitalization phase, N.P.S.     | 2000 →    |

The Bolinas electrostatic aerial/ground system grew out of the Marconi “Bent L” aerial as it has become known (fig. 1). Following the Marconi aerial, Alexanderson was to implement a greatly improved version. Marconi’s simple stripline became a sophisticated multi-loaded wave guide structure with an expanded underground network of wires. With the end of the Alexanderson phase and the installation of the shortwave, the electrostatic aerial was mostly demolished, with only a few masts remaining for what longwave radio remained. The U.S. Navy realized the importance of the electrostatic aerial at the onset of WWII. This would serve the needs of submarine communication, operating through ground currents rather than spatial waves. The Navy demolished what remained after they had no further wartime use for its function. The underground portion of the system, that of Marconi and that of Alexanderson, has remained intact through the various phases of the Bolinas developments. It is here the possible fourth phase of Bolinas wireless may be possible.

## 2) The Initial Layout of Marconi Wireless:

The first phase of the Bolinas aerial-ground system established the basic overall dimensions of the aerial structure and laid the central grounding system upon which all other phases would follow. The aerial pattern is shown in figure 2 and the ground pattern in figure 3. The aerial consists of a basic rectangle, 3000 x 600 feet, a 5:1 ratio. This rectangle is broken into three 960-foot sections of ratio 1.6:1. These are:

- a) First section
- b) Second section
- c) End, or terminal section (3<sup>rd</sup> section)

Also, there exists the input section which fans out from the powerhouse to the first mast row. The end section is folded downward, not reaching the fourth mast row electrically (fig. 4).

~~Sections~~ The supporting masts stood 300 feet in height and were fabricated from 30-foot steel sections about four feet in diameter. The steel was about 3/8 inch in thickness. The bolted split sleeves sections bound together to make up the entire length. This was an American Marconi standard design; easy fabrication and good strength. Four sets of guys, 90° apart, held each mast in position. Each set consisted of four wire ropes, stranded with 12 gauge steel wire, making each 1-inch in total diameter (fig. 5). These ropes of wire terminated upon 1000 cubic foot blocks of concrete set in the ground. These are the guy anchors (fig. 6). A somewhat smaller block of concrete served as the mast base in which the 300-foot steel masts were embedded (fig. 7). The old riggers told stories of climbing the inside of these masts, looking for rust. The wire rope guys were broken up with strain insulators to prevent the flow of parasitic currents. The number is unknown. Each insulator was about a foot long and about 3/4 ft. in diameter (fig. 8). These are possibly the largest strain insulators made. The exact arrangement of the distant, or terminal, end masts, opposite powerhouse, is yet to be verified. All mast bases and related guy anchors, totaling nine in number, exist today with the exception of the "mystery mast," 4B. This is the principle uncertainty in the reconstructive effort. In early accounts, the number of masts is given as eight or nine, in all probability starting with eight, the aerial ending at mast row three. As the aerial developed, mast row four would be added, as well as a row of auxiliary masts, 560 feet beyond mast row three. Any evidence of mast 4B is absent in physical form at present. In order for the massive mechanical forces developed by the aerial suspended within the boundaries of the supporting mast structures to resolve, the fourth mast would either be placed on the center line of the aerial, or a pair of masts would be placed on each corner, similar to mast row two. The asymmetrical



arrangement indicated in early drawings, with mast 4 on the left corner of the aerial, could not resolve the mechanical forces, and the aerial would tear itself apart. Geometric projection on an early photograph (fig. 9) clearly shows mast 4B however, but mast 1B is not seen, giving the established count of nine. Ultimately, because of the row of terminal auxiliary masts and an end section compensator, from the engineer's standpoint, mast 4B would necessarily have to exist, giving ten masts total in the fully developed aerial. Such is assumed in this reconstruction.

### View of the Complete Trans-Oceanic Station in California

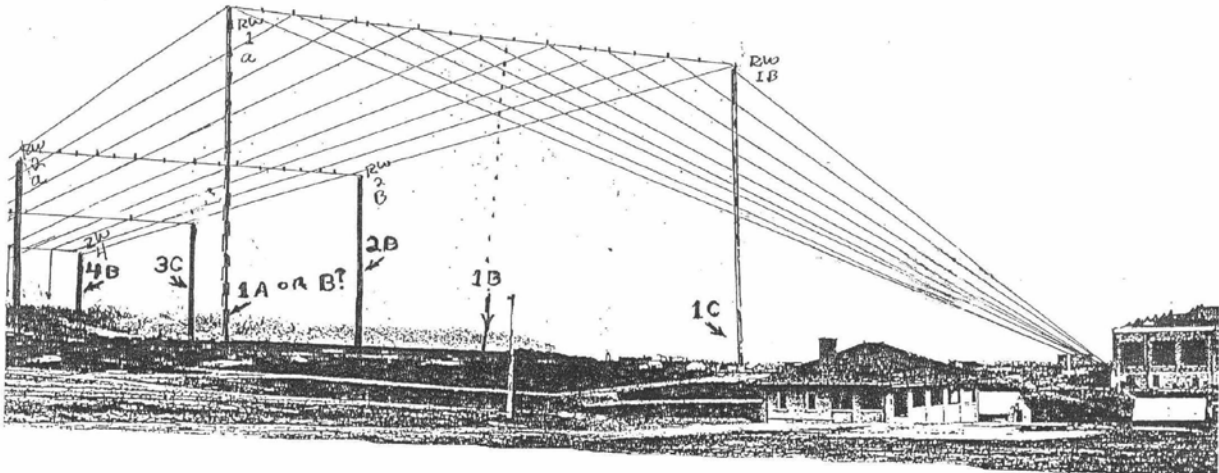

Initial Mast Layout of Marconi

### 3) Marconi Aerial Dimensions:

Upon the configuration of supporting masts, the Marconi wireless company erected the first electrostatic aerial to be seen at Bolinas. The structure was basic, consisting of 32 lines, evenly spaced, running longitudinal from the powerhouse to the aerial terminus. Each line consisted of a bronze wire rope of about ½ inch diameter. A partially buried section is to be found at the terminal row (fig. 10). This cable is woven with 20 gauge calcium bronze wires. The 32 lines fanned out from the main aerial anchor at the powerhouse (fig. 10A), rising to full height at mast row one. The 32 line mast row four ended upon a row of 32 auxiliary masts, the terminal row. Each auxiliary mast consisted of a 4-inch cast iron pipe set in a concrete block (fig. 11). Photographs indicate the masts to be about 12 to 15 feet in height. A recent water project destroyed most of the terminal row, but several mast bases are still seen on the right-hand side of the aerial perimeter (fig. 11A). Interpolation of a 1940 aerial photograph shows 32 mast bases total made up this row, but only 24 can be accounted for (fig. 12). The nature of this termination is unclear, but the absence of guy anchors in association with the row of auxiliary masts would indicate that each of the 32 bronze cables descended vertically, thus no lateral forces needed to be resolved with guy structures. Therefore it is assumed that the 32 lines formed a 90° angle at the line, 560 feet beyond mast row three, and the aerial was thus folded, ending at near ground level upon the terminal masts.



#### 4) Aerial Electric Constants:

The operating frequency of the disruptive discharge oscillator delivering excitation to the aerial-ground system is given at 44.77 kilocycles per second. The electromagnetic wavelength is thus 21 thousand feet. The length of aerial from the building end downloads, to the point of aerial termination, is 3000 feet. The ratio is thereby close to 0.16 to 1, a little over one-eighth wavelength. The downward section of the termination, consisting of the 32 downloads, constitutes a terminal condenser, and the aerial, an eighth wave stripline transformer. Thus the electrostatic capacity of the termination would appear as a resistance at the powerhouse end. The electrostatic capacity of the aerial-ground structure, as defined by its physical dimensions, is calculated as:

$$C_o = 32000 \quad \text{micro-micro-farads.}$$

And, as given by many sources, the electrostatic potential of the wireless aerials of Bolinas was 100 thousand volts, and thus the electrostatic power flow is:

$$P_o = 150 \quad \text{megavolt amperes,}$$

...at a current of 1½ thousand amperes. This is a Titanic quantity of electricity. The electrostatic capacity of the aerial-ground confined region is given as:

$$C_c = 25000 \quad \text{micro-micro-farads.}$$

This is the electricity sandwiched between the underside of the aerial and the surface of the ground structure beneath it. This electricity is of no use in the transmission process, but represents a useless surging. The electrostatic capacity of the upper surface of the aerial out to free space is estimated as:

$$K_s = 7000 \quad \text{micro-micro-farads.}$$

This gives a displacement current into space of 500 amperes and thus an electrostatic power flow of:

$$P_s = 50 \quad \text{megawatts,}$$

...this power representing the transmission of electric force into space, because the aerial operates in phase opposition to the ground structure. The bottom surface of the ground system sends a current of equal magnitude to the space current, that is, 500 amperes of current are transmitted into the earth's interior:

$$I_s = 500 \quad \text{amperes.}$$

The energy required by the aerial ground is equal to that delivered by the disruptive discharge oscillator which has been established to be:

$$W_o = 300 \quad \text{kilowatts.}$$

Since the stripline configuration of the aerial parallel to ground represents a section of transmission line of:

$$Z_c = 75 \quad \text{ohm.}$$

And of electrical length approximately one-eighth, it is:

$$R_1 = Z_r$$

That is, the electrostatic capacity of the aerial-ground sandwich does not appear at the aerial input, but the reactance of the aerial terminus appears as a resistance to the oscillator, providing the required energy. Hereby the oscillator delivers its electrostatic power to the displacement current and that power confined appears as a leakage of electrical energy. This would appear as the Marconi wireless design principle.

The Marconi electrostatic aerial was determined by Marconi to be directive in a direction longitudinal with the axis. According to electromagnetic principles, no such directivity would exist. The aerial would transmit in all directions. However, the Marconi aerial is a low impedance section of transmission line, incapable of electromagnetic radiation. The electrostatic wave of propagation along the free space portion of the aerial is about 1½ times faster than the electromagnetic velocity of light. Through the experiments of Marconi (fig. 13), the electrostatic wave is launched longitudinal with respect to the aerial axis and in a distance much shorter than a wavelength. The free space velocity is given by the relation:

$$\sqrt{C/K} = V_o / V_c = \gamma^{-1}$$

That is, the ratio of velocities squared is equal to the ratio of electrostatic (dielectric) capacities by substitution:

$$\gamma^2 = 2.17$$

...and the free-space wave velocity is thus:

$$\gamma = 1.5 \quad \text{times the velocity of light.}$$



From the physical dimensions of the Marconi wireless electrostatic aerial, through the use of standard radio formulae as given by the R.C.A. handbook: "Radiotron Designers' Handbook," and by Frederick Terman in his "Radio Engineers' Handbook" (Stanford University), the electrical constants have been determined.

#### 5) The Alexanderson Phase of Bolinas Aerial Development:

During the transitional period from Marconi to Alexanderson, the actual development sequence is somewhat blurred. Judging from the dedication plaque that once was affixed to the left of the door, it would appear that historical facts may have been altered. Blueprints of the aerial to follow that of Marconi were dated 1919. The plaque states the powerhouse was completed in 1920 by the J.C. White Engineering Company. Out of this transitional period, and through the hands of the U.S. Navy, the General Electric Corporation and the Radio Corporation of America, the wireless system of Ernst Alexanderson was created at Bolinas. The system of Alexanderson was much more sophisticated than the simple "32 wire" Bent L it replaced, however it was bound by the existing mast structure of Marconi. The Alexanderson aerial was made up of a number of star radial elements ~~called triatics~~, these being suspended between the mast rows in groups of three. The wire utilized in triatic construction is unverified, but is possibly the three-strand no. 10 copper-clad steel cable found in quantity along the bluffs. This wire would meet the required technical specifications (fig. 14). It is not known if one or two rows ~~of~~ triatics were utilized in the makeup of the entire aerial. Two rows would be most likely, but certain conditions favor one row (fig. 15). One row will be utilized for reconstruction. The number of "spokes" in each triatic web is unknown, but 16 is a number which resolves the developed mechanical forces.

#### 6) Additional Structures Required:

The aerial of Alexanderson required the installation of a sequential set of structures physically and electrically in contact with the ground. Downleads would drop from each section of the overhead structure to its corresponding ground unit. Auxiliary masts or rod anchors held the downleads in place. The ground-based structure made up the loading, or compensating stations that regulated the flow of power along the aerial. The simple stripline structure of Marconi was now a multiple loaded waveguide structure. Four compensator stations existed in all (fig. 16).

The sequence follows:

1. The input section compensator, series and shunt loading;
2. The first section compensator, shunt loading;
3. The second set compensator, series loading;
4. The end section compensator, shunt and series loading.

In tandem, the compensators compensated, or rather neutralized, the electromagnetic propagation in the space confined by the bottom surface of the aerial structure, and the top surface of the underground structure. That is, the useless electricity sandwiched between the aerial and ground is neutralized, or compensated for. This is called the Alexanderson principle and is similar to the eighth wave principle of Marconi, but more developed.



## 7) Ground Structure Details:

Each station consists of large concrete bases (fig. 16) which served as the mounting for a 12-foot high coiled winding of heavy copper litz cable of about 300,000 circular mills section. Litz was a special weave to allow full current penetration into the available mass of metallic conductor. These coils existed in two forms: potential coils, shunt connected (fig. 17), and current coils, series connected (fig. 18). Wooden racks of porcelain jars made up the series condensers that were utilized in conjunction with the series coils. The absence of photographic evidence and inadequate breakage makes condenser reconstruction difficult. Much mica is found in the breakage, indicating condenser structures. Numerous grounded no. 18 soft copper wires and fragments of copper flashing indicate the series condenser was housed in a copper-clad wooden hut. Wooden foundations are seen in a transverse line to the coil axis on the terminus side of the series coil mount. Figure 17 has such a copper shack in the background. The large coiled windings and racks of mica condensers existed in various combinations at each compensator station. Various phases of development of the compensators is to be noticed, the breakage of one buried beneath the next. Various auxiliary masts and anchors are found in the area of each station, as diagrammed by figure 16. Through the use of these compensators, the aerial would have no wavelength, unlike the eighth wave structure of Marconi. The entire aerial electrostatic field of the Alexanderson system would oscillate in unison, whereas the Marconi structure lagged behind with distance from the powerhouse, being one-eighth of a cycle, 2.5 microseconds late at the terminal end. Thus the entire electrostatic field of the Alexanderson was in step with the powerhouse alternator (fig. 18A).

#### 8) Compensator Details, First Section Station:

The first section compensator station consisted of a pair of shunt coils spaced about 300 feet apart on a line transverse to the aerial center line. The spacing is symmetrical about the center line. Existing bases are shown (fig. 19). Passing up through the concrete of these shunt coil bases are 8 each of no. 8 solid soft copper wire ground leads. These terminate upon 8 groups respectively of 4 half-inch N.C. bronze studs (fig. 20), these serving to hold the shunt coil to the mounting base and ground its neutral side. The ground wires extend from the base (fig. 21), outward in a star radial configuration. For a few hundred feet, there is no metallic contact between the grounds of the pair of concrete bases, nor to the central ground. One would think such contact would exist. No breakage is to be found around the first section coil bases and no evidence of auxiliary masts or their anchors is to be found. It thus may be assumed the downlead descended from the aerial direction to the top of the coiled windings. A foundation for a small coil with grounded studs and a copper-clad shack is found off to the side as well as a major grounding terminal (figs. 22 & 23). It is not known what part of this may have served in the Bolinas station operation. The first section compensator served as a longitudinal magnetic susceptance, compensating for the transverse dielectric components of the aerial-ground first section electromagnetic field. This component is hereby neutralized.



## 9) Compensator Details, Second-Section Station:

The second section compensator appears to have gone through several phases of development. Shunt coil breakage is found buried beneath existing coil bases. Closely spaced coil mounts are to be seen, one upon the aerial center line, appearing to be the first, and a second coil mount off to the side several feet. One intact shunt coil sectional insulator was extracted from the central base. Mounting bases are shown in fig. 22. No grounding wires can be detected or located in association with these mounts or their bronze mounting studs. It is seen that two studs exist on the sides of the mounting bases, indicating a lower terminal configuration on the coiled windings. The studs are in the direction of the aerial terminus, the center mount aligned with the aerial axis, and the side mount directed towards the axis at an angle. These lower terminals, along with the existence of series coil breakage, indicate the coils were of the series current variety and connected in multiple with respect to each other. One 4-inch cast iron pipe mast base and its guy anchors are seen on the input side of the compensator coil mountings, indicating a single downlead from the overhead structure, descending vertically to the 4-inch auxiliary mast. The guy anchors, of the concrete block variety, indicate leads from the auxiliary mast (fig. 23), led to the top of the series coils. Located transverse to the aerial center line axis a trench is found, this containing condenser breakage, no. 18 soft solid copper drain wires, and wooden 6 x 6 foundations. Some copper flashing fragments are also noticed. This would indicate a series condenser and its copper-clad wood enclosure. Leads would have led to the condenser from the terminals at the coil bases. Beyond the compensator components toward the aerial terminus, rod-type guy anchors are to be found (fig. 24). These would serve as teathers for the lead, leading back up to the aerial structure. It would appear that two upleads may have existed. Because of the series connection of the second section compensator, the first and second sections of the overhead aerial structure would be electrically insulated from one another at the supporting mast rows 2A and 2B. Since the current in the downlead is in the opposite direction to that of the upleads, no electromagnetic radiation could take place from these leads. It is assumed that this compensator station was initially a single shunt coil, but as the aerial developed, this was altered to a series coil configuration. The series condenser performed a function conjugate to that of the shunt coil susceptance of the first section compensator. It served as a longitudinal dielectric reactance, compensating for the transverse magnetic component of the aerial-ground electromagnetic field. This component was thus neutralized. The function of the series coils would be to add momentum to the magnetic field component of the aerial, so as to bring this field component to an equal intensity with the dielectric field component of the aerial. Thus the components would be balanced and the aerial would operate in a space scalar condition, that is, with no wavelength.

#### 10) Compensator Details, End Section Station:

The end section station is by far the most complex, being a superimposition of the shunt configuration of compensator station, first section, and of the series coil-condenser configuration of compensator station, second section. Like that of the second section, the end section compensator saw various stages of development. The shunt coils have the same position and the same grounding configuration as those of the first section. The series coil in this case is a single unit set upon the central axis of the aerial (fig. 25). The condenser configuration is identical to that of section two. Breakage found in this area is shown in figure 26. Two 4-inch cast iron auxiliary masts are to be found at some distance away toward the input end of the aerial, each with its own single concrete guy anchor. Geometric progression directs from the mast and anchor sites to a central mast, or anchor, close to the terminal face of the central series coil mounting, with breakage and a rod-type anchor to be found at this point. Concrete anchor blocks face this side of the coil mount, but no mast can be verified (fig. 27). Numerous rod-type anchors are to be found at some distance away from the compensator components (fig. 28). These are thought to be the upleads to the end section of the aerial, the 4-inch pipes at the input side being the downleads from the aerial. Other rod anchors, ground wires, and fragments of concrete are seen, but a definite geometric pattern is not indicated. How the leads to the shunt coils were carried is unknown, as no evidence of any kind is seen for the required transmission structures. While the physical layout is uncertain, the Alexanderson principle defines the electrical connections required. Like compensator station, input section, the downleads carry current in the same direction and thus radiate electromagnetic waves. However, as with compensator station, second section, the series current on the two input downleads is of opposite direction to that of the upleads back to the aerial. Thus this current cancels and no electromagnetic radiation is generated.



### 11) Compensator Details, Input Section:

The input section compensator station is located next to the powerhouse (fig. 29), and surrounds the main aerial anchor. A series coil mount is located on the building side of the main aerial anchor (fig. 30), and a shunt coil mount of unique construction is located nearby on the aerial side of the anchor (fig. 31). The shunt coil is grounded to the Marconi central ground through a pair of no. 4 soft solid copper wires (figs. 32 & 33). Numerous concrete bases are found to the side, some pre-dating others (fig. 33). Drain wires project from the bases. These supported a rack structure fabricated from 1½-inch rigid steel pipe. The newer structure is thought to have carried the condenser bank; condenser breakage is to be found in this area. The older structure is thought to have carried the high tension leads from the series coil to the shunt coil, and such insulator breakage is found. The connections and layout of this input section station is unknown. However, it is known that a potential of 2400 volts @ 200 kilowatts entered, and 100 kilovolts @ 200 kilowatts left the input compensator through a series reactance of coils and a shunt susceptance of condensers, a configuration known as an oscillation (Telsa) transformer. This would be the series coil mount. The shunt coil is theorized to have had a resonant relation with the electrostatic capacity of the distant aerial terminus. This would act as an excitation current to keep the aerial going, since it would have to flow from input to terminus along the entire aerial length. These possibilities need verification with scale models and further photographic or diagrammatic evidence.

## 12) The Third Phase of the U.S. Navy and WWII:

The partially demolished electrostatic aerial of Bolinas saw partial resurrection in 1940 to meet the needs of the U.S. Navy and the war effort in the Pacific Ocean. Details are non-existent, except for a few photographs. The aerial of the Navy was only an approximation of the highly developed aerial of Alexanderson. The end section no longer existed, and the Navy aerial terminated upon the central mast 3B of mast row 3. A new anchor was set behind this mast in order to resolve the mechanical forces (fig. 34). The end section compensator was absent, and in all likelihood, so was the first section compensator. The input and second section compensators were enclosed in large copper-clad wooden shacks. The main aerial anchor had two slots jackhammered out to make way for the input shack, and trenching defines both input and second section shack perimeters (fig. 25). Details are not known and a possibility exists that the input section shunt coil may have been a Navy addition, never existing at all for previous phases of development. The no. 4 ground wire and different geometry suggest this. From the engineer's standpoint, the Navy aerial was in all probability a rigged approximation, and not of enough significance to warrant a detailed study.



### 13) Possible Fourth Phase Developments:

As stated before, the bulk of the Marconi central ground and the Alexanderson shunt coil grounds, as well as other lesser grounding structures remain intact today. Testing on the joint grounding of the right-hand first section shunt coil mount indicated a ground terminal of exceptionally low impedance (fig. 20). In the fourth phase, these grounds could serve in a system of wireless, having no aerial structure. Their use for the study of geo-electric signals is also worth consideration. Scale models of the Alexanderson system may be constructed to facilitate historic representation and scientific study. One such model is proposed. It is hoped that these ideas will be considered by the National Park Service.

### 14) Location of Related Breakage and Artifacts:

Scattered upon the surface, and buried beneath the clay of the sagging coastal bluffs is a vast quantity of breakage and artifacts relating to the Bolinas electrostatic wireless history. Numerous fragments of insulators, and sections of wire and cable are to be found. A major portion of series coil sectional insulators have been located, enough for a substantial model (figs. 37 & 38). Transmission insulator fragments establish the basic form of their existence (fig. 39). These consisted of glazed porcelain tubes filled with tar. The diameters varied from two to three inches and the lengths varied between one and two feet. A single fragment of an antenna insulator was located in the central dump. This also was a porcelain tube of six inches in diameter, the length being eight feet, according to G. Kovats. Two intact guy insulators were also located (fig. 8). A single shunt coil sectional insulator was extracted from a concrete coil mount. Large quantities of the one-inch diameter wire rope that made up the main mast guys is found in quantity in the north part of the central dump, and along the bluffs to the northwest, in the direction of the powerhouse (fig. 41). Three-strand steel core copper is found in quantity along the bluffs to the southeast of the central dump. The dump itself is a concentration of Bolinas history (fig. 42). About 200 feet toward the powerhouse from the central dump is the Marconi dump. Large quantities of tile insulator breakage is found here (fig. 43), consisting of condenser jar fragments and various pieces of conductor supports. The single intact condenser jar has been stolen, but a fragment gives the date as May 27, 1913 (fig. 44). The manufacturer had the initials G.W.S.A. Company (fig. 45), which may have stood for "... Wireless Specialty Apparatus Company." Further toward the powerhouse, vast quantities of Marconi and Alexanderson breakage is found. The surface of the ground is covered with bits of insulators, jars, bushing and metal fragments (fig. 47). A detailed excavation is needed in this area so important artifacts can be cataloged and safely stored. Presently, Commonwealth will not allow for safe storage, and

# PROPOSED BOLINAS ANTENNAE

ALEXANDERSON, 19 Kc/s  
1919 - 1924

MARCONI, 44 Kc/sec  
1916 - 1919

38  
37  
36  
35  
34  
33  
32  
31  
30  
29  
28  
27  
26  
25  
24  
23  
22  
21  
20  
19  
18  
17  
16  
15  
14  
13  
12  
11  
10  
9  
8  
7  
6  
5  
4  
3  
2  
1  
0

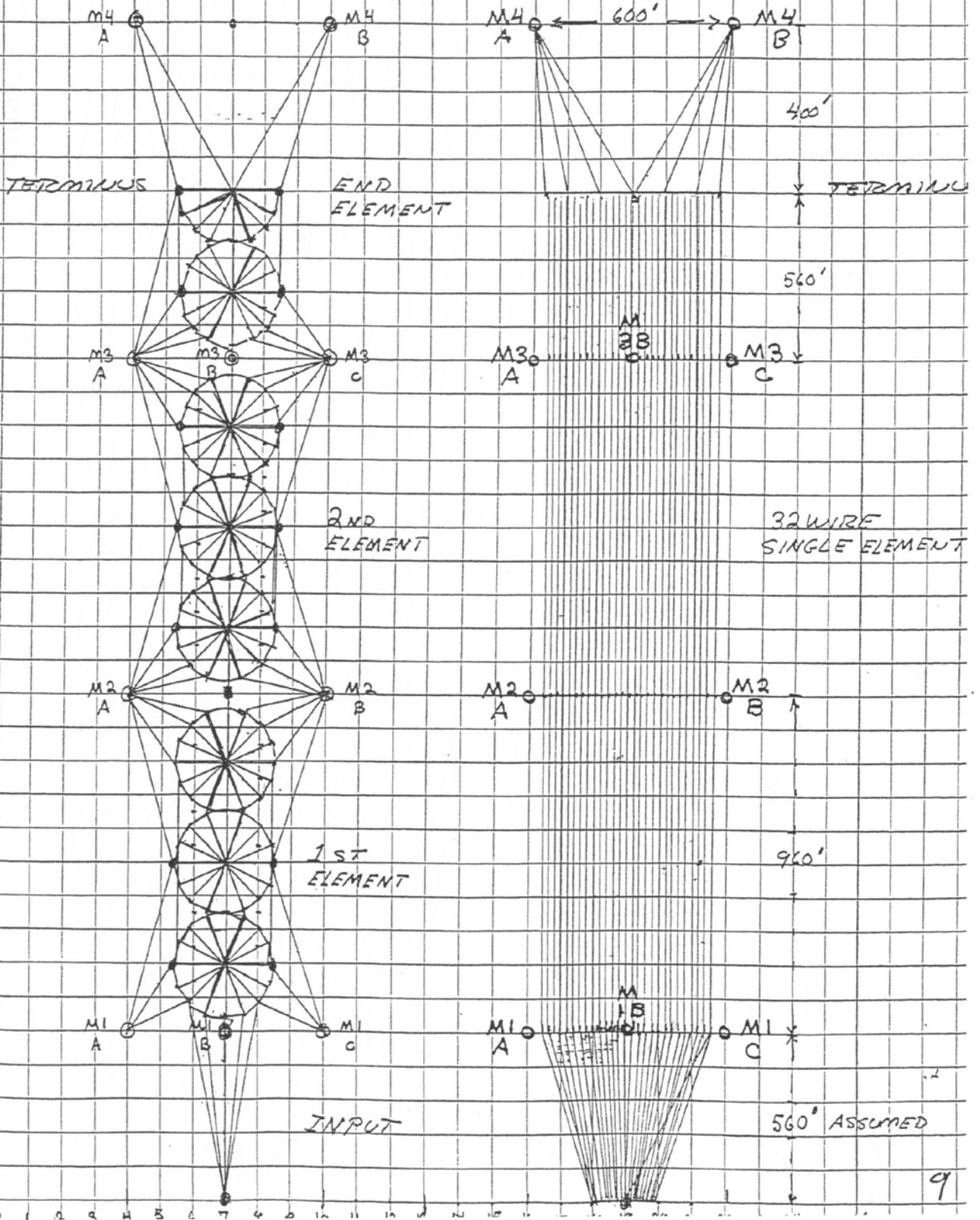



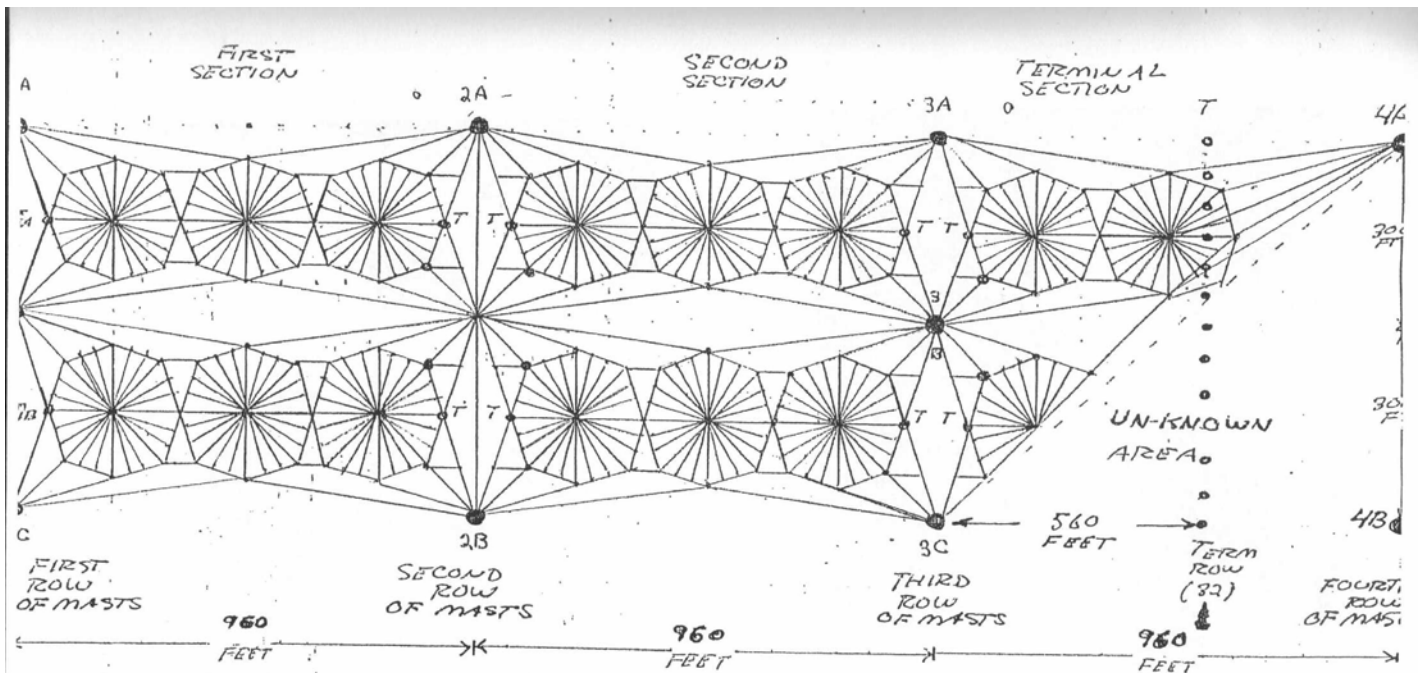

TWO ROW  
TRITACTIC  
CONFIGURATION  
& GENERAL MAST  
LOCATION

← 2850 FEET TOTAL + (450 FT TO BLDG) →

NOT TO SCALE

43

10



MARCONI GUYING WIRE ROPE

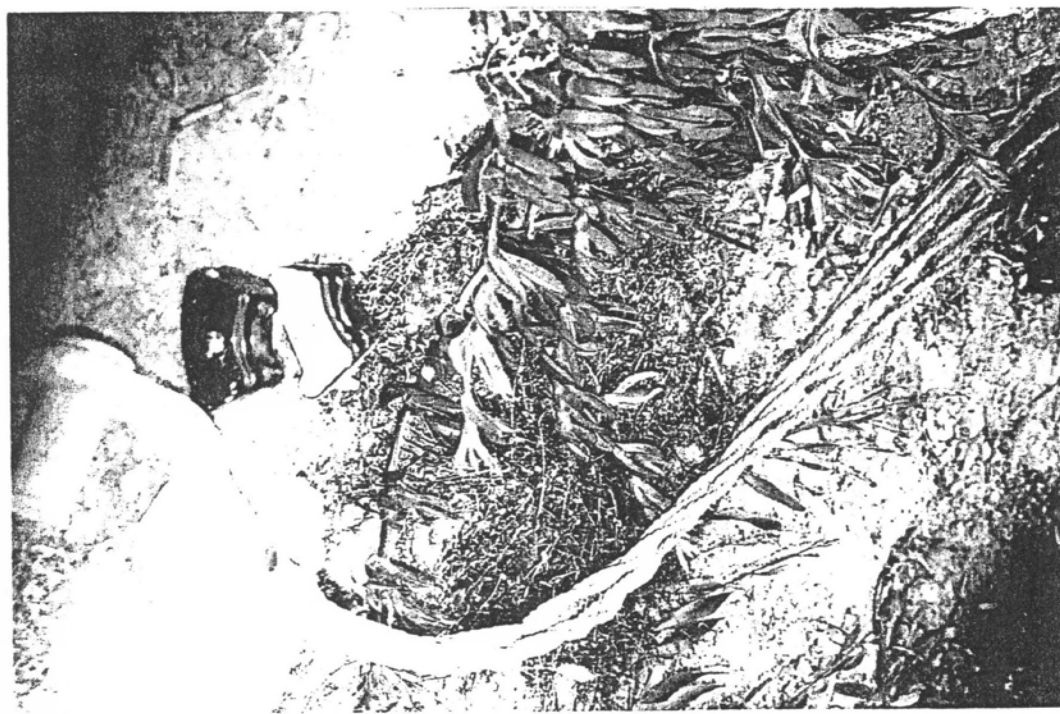

PART OF WIRE  
ROPE TERMINATION





12KV  
MANHOLE

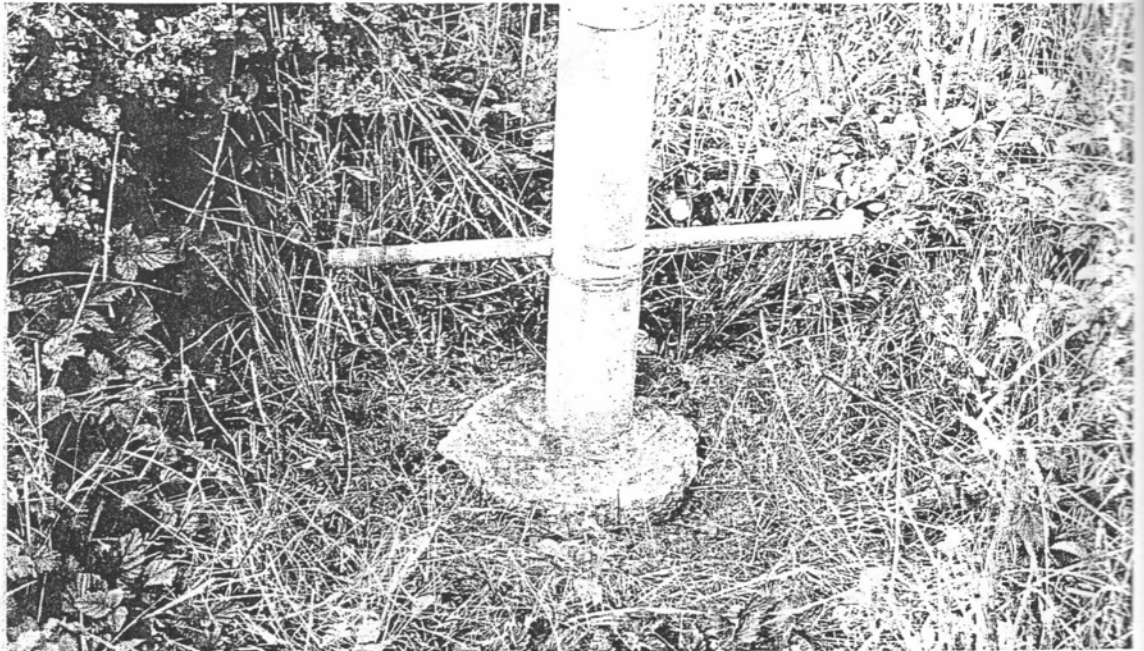

PTB / Fig. 6A: tridown anchor

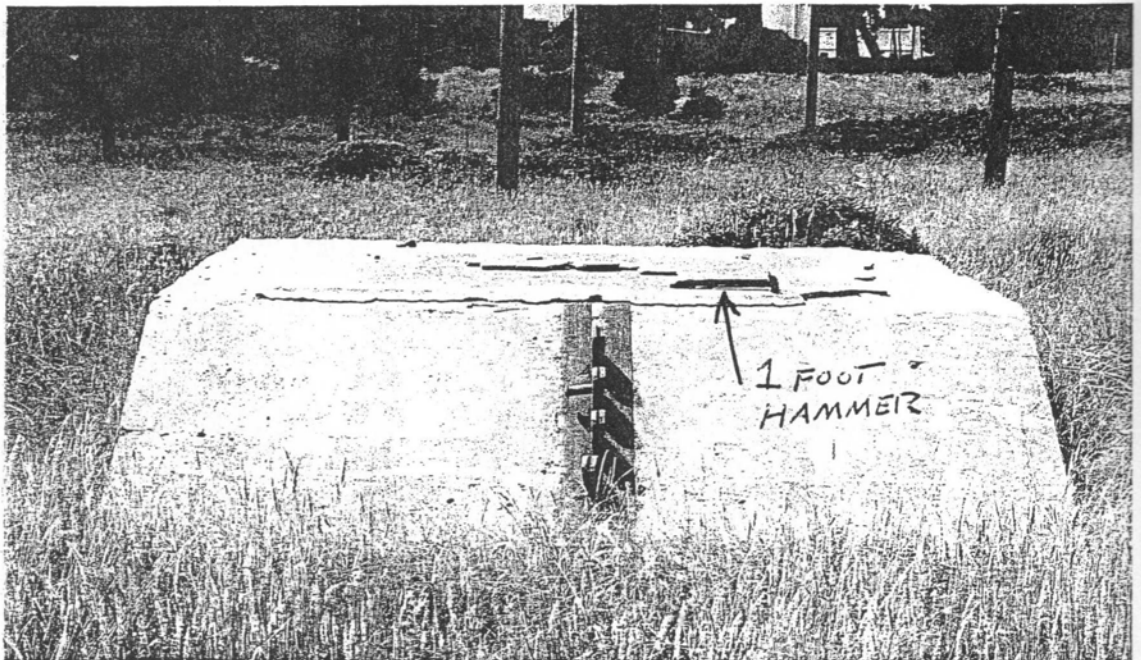

PTB / Fig. 6: guy anchor





PTB/ Fig. 7 : Mast base

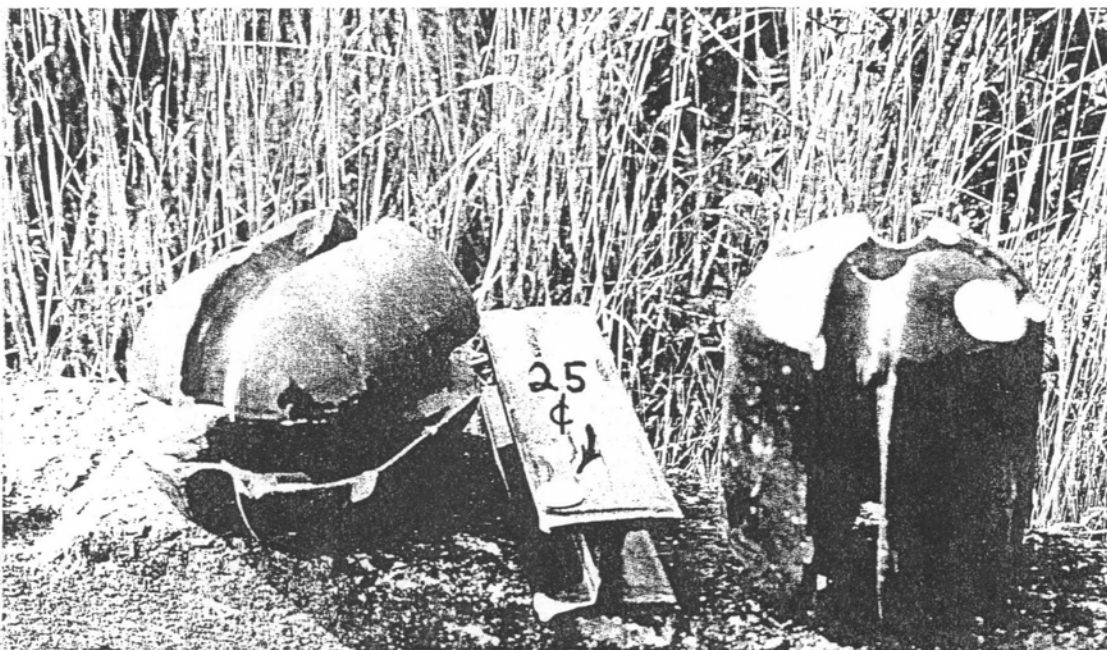

PTB/ Fig. 8 : guy insulators with cable tray in center



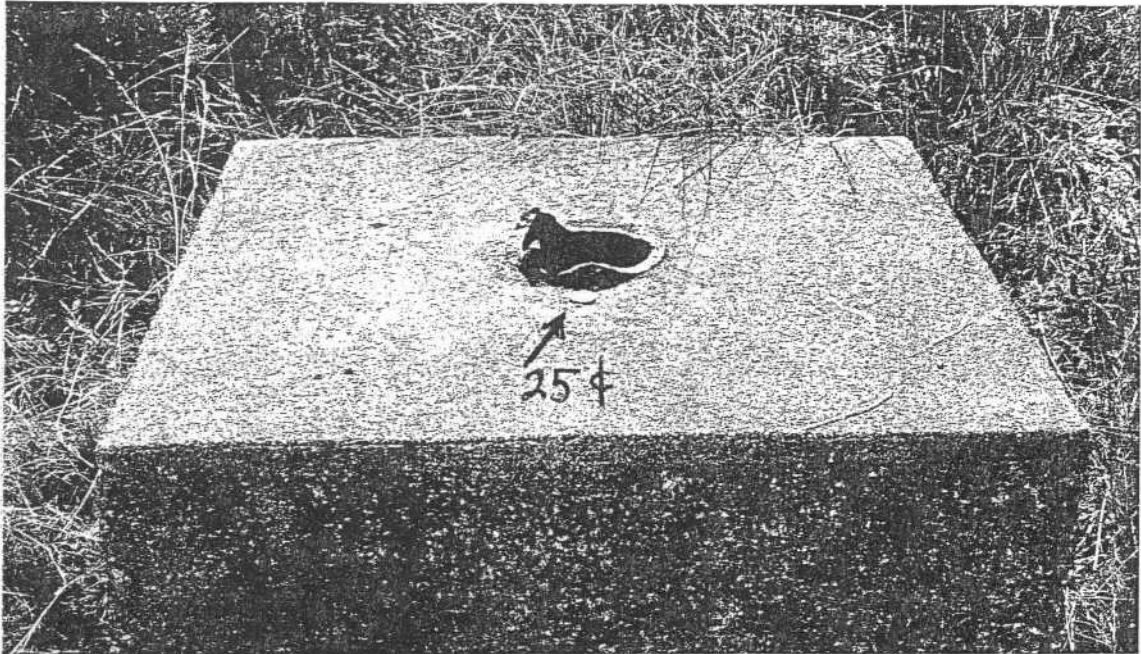

PTB/ Fig. 11: aux. wast

PTB/ Fig. 10: aerial wire







PTB/ Fig. 11 A: terminal mast row

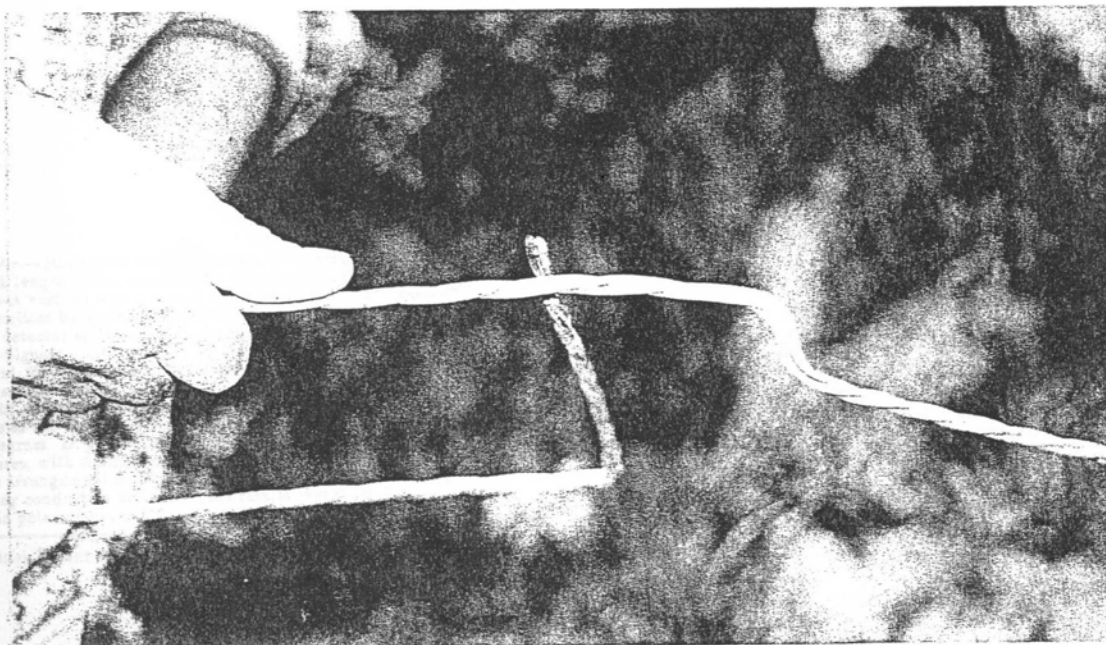

PTB/ Fig. 14: triaxial wire

Radiation of Electric Waves Mainly Confined to Certain Directions.

By G. MARCONI, LL.D., D.Sc.

(Abstract of note communicated to the Royal Society by Dr. J. A. Fleming, F.R.S. Received March 15th. Read March 22nd, 1906.)

THIS note relates to results observed when for the usual vertical antenna employed as radiator or absorber in wireless telegraph stations, there is substituted a straight, horizontal conductor placed at a comparatively small distance above the surface of the ground or water.

When an insulated horizontal wire A B, such as is shown in fig. 1, is connected at one end to a sphere of a spark gap, the other sphere of which is earthed, and sparks are caused to pass between the spheres, it will be noticed on investigating the space around such an oscillator that the radiations emitted reach a maximum in the



FIG. 1.

vertical plane of the horizontal wire A B, and proceed principally from the end A, which is connected to the spark gap, whilst the radiation is nil, or reaches a minimum, in directions which are approximately  $100^\circ$  from the direction in which the maximum effect occurs.

I have also noticed that any horizontal conductor of sufficient length placed upon or at a short distance above the surface of the ground, and connected at one end through a suitable detector to earth, will receive with maximum efficiency only when the transmitter is situated in the vertical plane of the said horizontal receiving conductor and in such a direction that the end connected to the detector and to the ground is pointing towards the transmitting station.\*

If, therefore, such a horizontal conductor be swivelled about its earthed end in a horizontal plane, the bearing or direction of any transmitting station within range of the receiver, can be ascertained.

I have carried out a number of tests with transmitters and receivers having radiating or receiving antennae or conductors arranged as follows:—

1. Transmitting conductors consisting of horizontal wires, the radiations being received at a distance by means of the usual vertical wires suitably attuned.
2. Both transmitting and receiving conductors consisting of horizontal wires.
3. Transmitting conductors consisting of one or more vertical wires with or without capacity areas at the top, such as have been generally employed in wireless telegraphy, the radiations being received by means of horizontal conductors.

With arrangements such as are referred to in (1), the following tests have been carried out:—

*Transmitter.*—Horizontal wire 100 metres in length, direct excitation, spark length 2 cm., wave-length approximately 600 metres.

*Receiver.*—A vertical wire 8 metres in length, tuned to the period of the transmitter by means of a synchronising coil, and connected to a magnetic detector and to earth in the usual manner.

*Results.*—Signals quite distinct at 16 kilometres in the vertical plane of the horizontal transmitting wire and in the direction of its earthed end; weak at 10 kilometres in the same vertical plane, but in the reverse direction; inaudible at 6 kilometres at right angles to the directions above mentioned.

Polar diagram D gives the values of the received current in micro-amperes, with conditions as marked under the diagram.

With the arrangement mentioned at (2), i.e., both transmitting and receiving conductors horizontal, the results over short distances are shown in polar diagram B.

\* See British Patent Specification No. 14,785, July 18th 1905

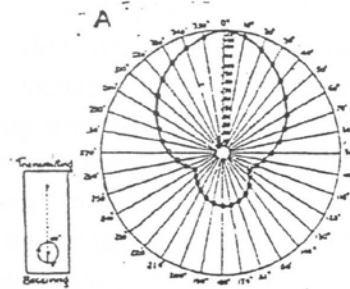

Curve showing observed current in micro-amperes at earthed end of receiving conductor under the conditions of direction shown below:—  
Transmitting conductor.—Vertical, fixed height 14 metres.  
Receiving conductor.—Horizontal, rotating from  $0^\circ$  to  $360^\circ$  1.50 metres above ground.  
Length of transmitting conductor.—45 metres.  
Length of receiving conductor.—30 metres.  
Distance of transmission.—680 metres.

FIG. 4.

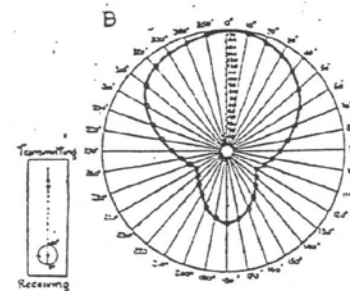

Curve showing observed current in micro-amperes at earthed end of receiving conductor under the conditions of direction shown below:—  
Transmitting conductor.—Horizontal, fixed 1.50 metres from ground.  
Receiving conductor.—Horizontal, rotating from  $0^\circ$  to  $360^\circ$  1.50 metres from the ground.  
Length of transmitting conductor.—30 metres.  
Length of receiving conductor.—30 metres.  
Distance of transmission.—225 metres.

FIG. 3.

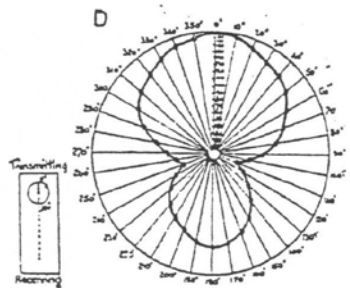

Curve showing observed current in micro-amperes at earthed end of receiving conductor under the conditions of direction shown below:—  
Transmitting conductor.—Horizontal, rotating from  $0^\circ$  to  $360^\circ$  1.5 metres above ground.  
Receiving conductor.—Vertical, fixed height 18 metres.  
Length of transmitting conductor.—50 metres.  
Length of receiving conductor.—18 metres.  
Distance of transmission.—250 metres.

FIG. 2.

MARCONI DIRECTIVE  
ANTENNAE FIG 13



**Marconi's Directive Antenna.** — In 1906 Mr. Marconi presented to the Royal Society an account of some experiments which



FIG. 210. Marconi's directive antenna.

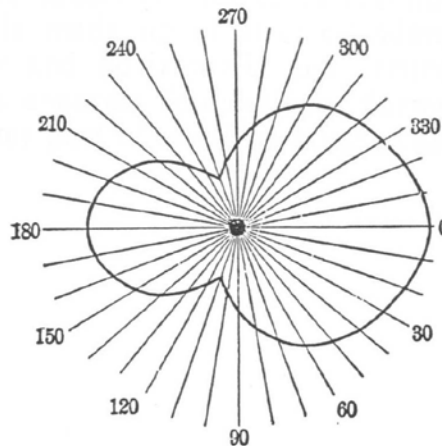

FIG. 211. Diagram of intensity about Marconi's directed antenna.

showed that an antenna having a short vertical part and then extending away to a considerable distance in a horizontal direction, as shown in Fig. 210, emitted electric waves most strongly in the direction *D* away from which the free end of the antenna points.

Marconi's experiments showed for a given distance between the receiving station and the transmitting station the relative intensities in different directions which, plotted in polar coördinates, give a curve of the form of Fig. 211. In this figure the relative intensities in different directions are the lengths of the radii drawn from the origin to the curve.

In like manner a receiving antenna consisting of a short vertical part and a long horizontal part receives more strongly waves arriving from the direction away from which the open end of the antenna points. Mr. Marconi has utilized this principle in the construction of his powerful stations at Wellfleet and at Poldhu.

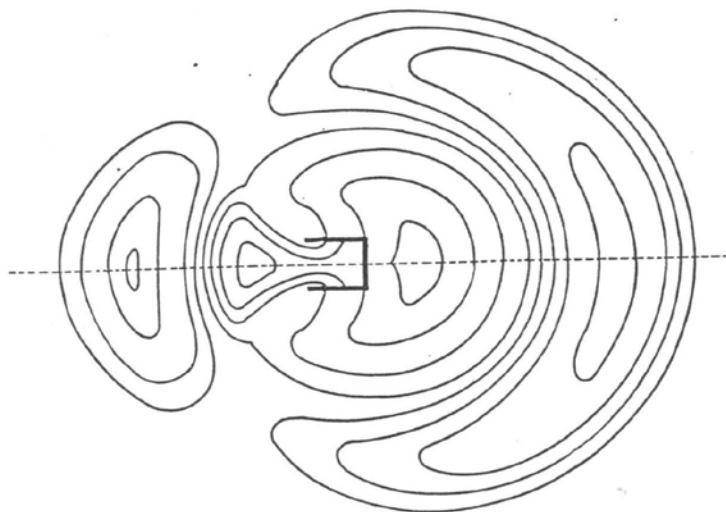

FIG. 214. Dr. Uller's diagram of field of electric force about the bent antenna.

235. **Marconi Tubular Masts.**—One of the most interesting features of the original construction work at the Marconi high power stations was the erection of the steel tubular masts, the successive stages of erection being shown in Figs. 311, 312, 313, 314 and 315. The mast is made up of steel cylinders (Fig. 311), constructed in quarter sections, flanged vertically and horizontally and secured together by bolts stayed with steel cables. These stand in a concrete foundation. Surmounting the main steel column was a wooden top mast, the lower part of which is squared and set in square openings in the plates between



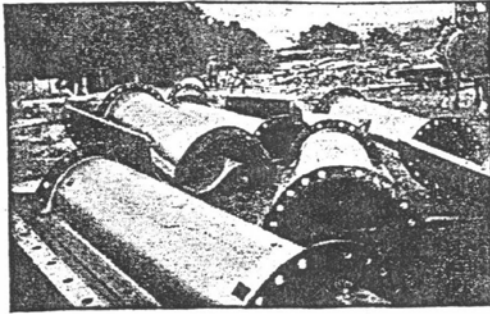

Fig. 311—Showing Steel Semi-Cylinders for the Marconi Tubular Mast.

arms which carried blocks through which reaved the material hoisting ropes. A square wooden cage was suspended from the hoisting arms by four chain hoists so that the workmen in it could move themselves up and down to bolt the sections together. This is more clearly shown in Fig. 314.

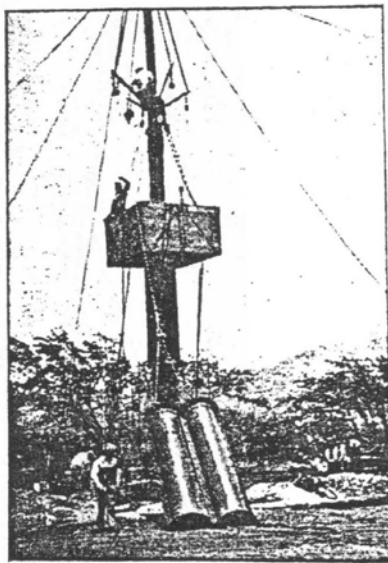

Fig. 312—Showing Workmen's Cage Which is Carried to the Top During the Process of Erection.

elastic extension of these stays was not so great as to result in the vibration of the mast during heavy winds. It was essential to break each stay into short lengths connected with

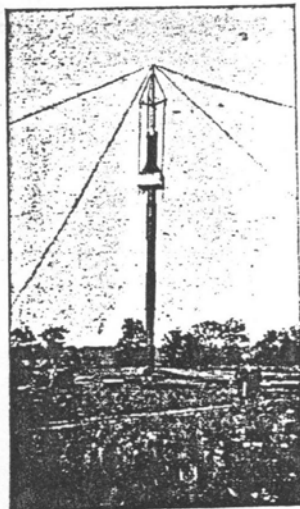

Fig. 313—A Tubular Mast in Early Stages of Construction.

the steel cylinders. The hoisting arms attached to the upper end were fitted with blocks and hoisting cables. Attached to these arms were chain hoists supporting a square wooden cage (Fig. 312) for the workmen, which was lowered or raised as the demands of the work required while the sections were being bolted together.

The *wooden topmast* was the keynote of this novel system of construction, operating like a man who pulls himself up by his bootstraps. The lower half of this topmast is of square section and is guided by a square hole in the diaphragm plates between each section. The topmast was fitted with a set of hoisting

Assume that two cylinders have been bolted to the bed plate, the mast rising through the center. The sections of the third cylinder were raised by a steam winch and bolted in place by the workmen. Then a heavy flexible steel rope was temporarily anchored at the top of this last cylinder. Attached to the top of the steel section, this cable led down inside the cylinders and around a wheel in the foot of the wooden topmast; then it was carried up again on the other side and around a sheave to the top of the steel, thence to the winch. By pulling on this rope the topmast was raised the length of one cylinder and pinned through holes in both steel and wooden masts. With the addition of a new cylinder, the topmast was raised again, the pin supporting it until this was brought about (Fig. 313). The stays were attached at the required points as the erection of the mast progressed.

The stays, by means of which each mast is supported, are made of heavy plough steel cable, possessing great tensile strength. For each mast thousands of feet of this cable were used, great care being taken to see that the

great porcelain insulators in order that the electrical energy might not be absorbed, led to the earth by the stays and lost for purpose of wireless operation. For all connections at the masts, insulators and anchorages, special bridge sockets were designed. This did away with the necessity for splicing and permitted a perfect and straight pull, thereby developing the strength of the cable. Heavy concrete blocks were used as anchorages for the stays. The completed mast is shown in Fig. 315.

In addition to the antennae stretched between the masts, great quantities of wire were placed in the ground about the stations in order to provide an efficient earthing system or ground connection. Told in brief, a circle of zinc plates is buried in a trench, bolted together and jointed to the wireless circuits of the power house by copper wires. Wires radiate from the zinc plates in the ground to a set of outer plates, from which extend another set of earth wires placed in trenches running the full length of the aerial. The general scheme for the earth connection is shown in Fig. 320.

**236. Radio-Frequency Circuits of the Damped Wave Transmitters.**—A description will now be given

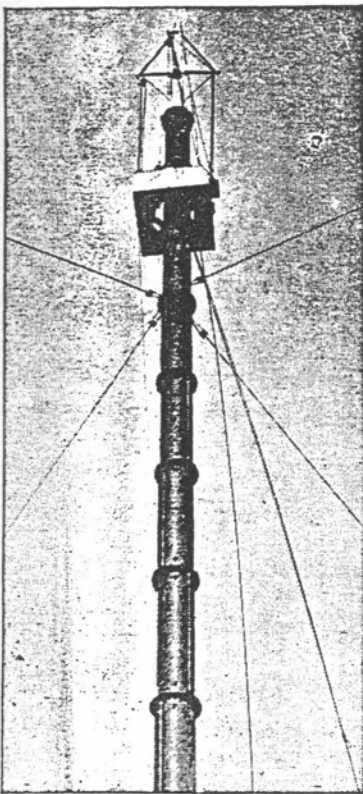

Fig. 314—Showing the Cage and the Top Mast Several Hundred Feet from Earth.

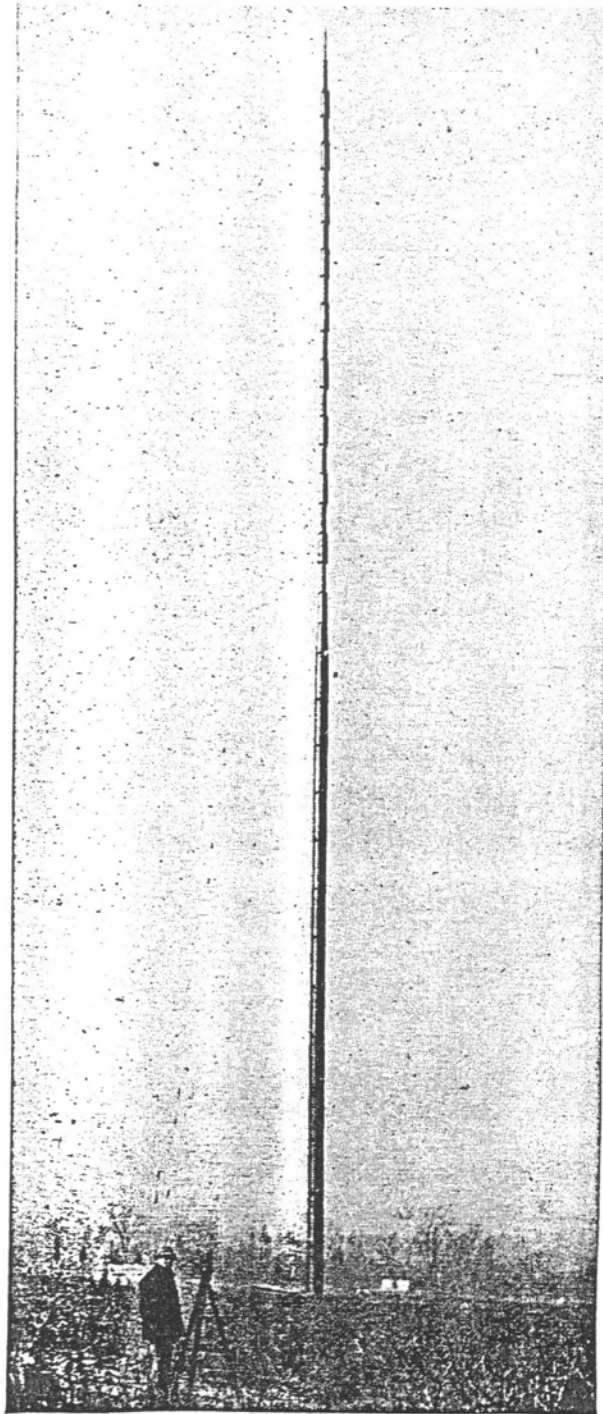

Fig. 315—Completed Mast (Guys Not Shown).



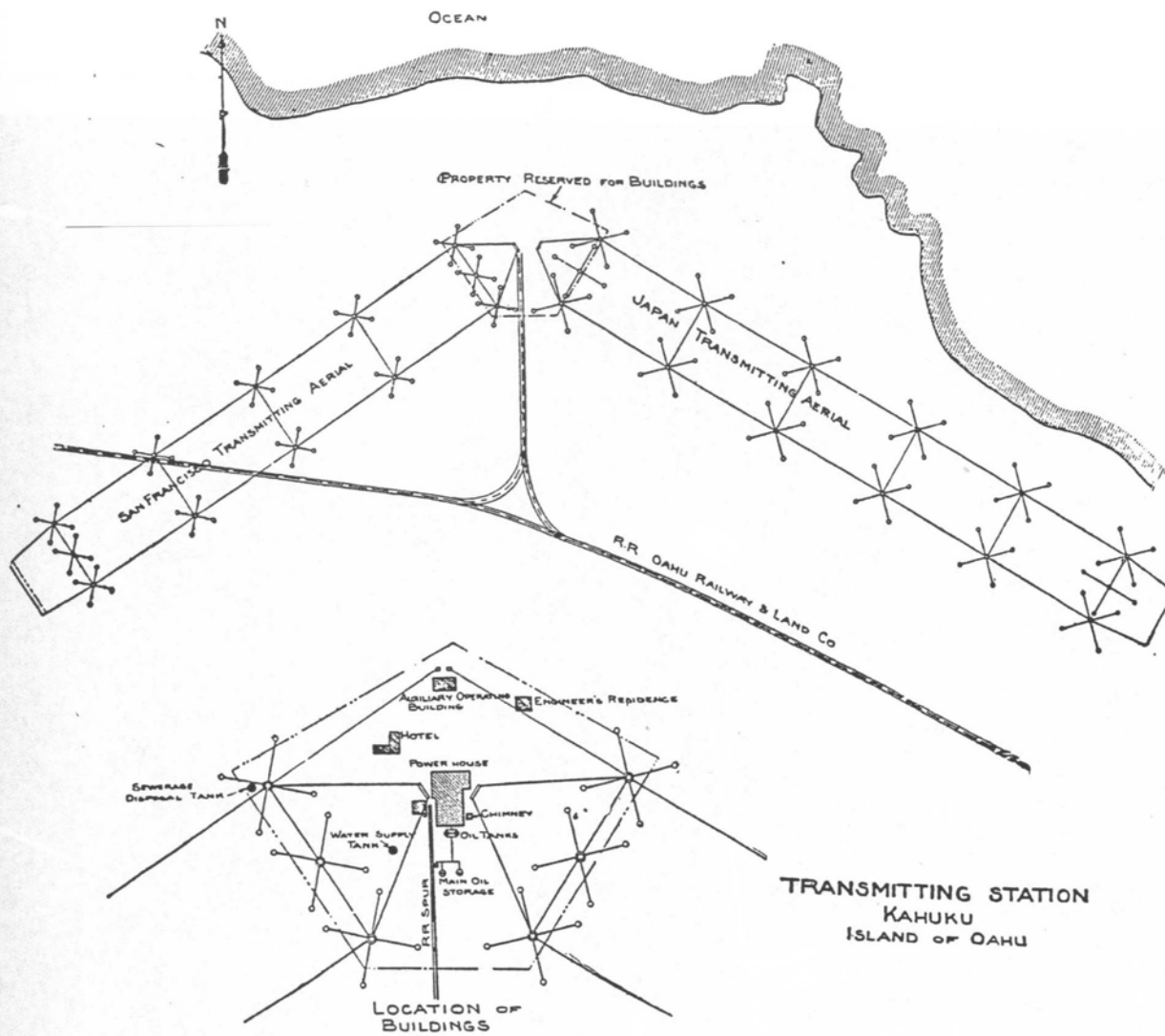
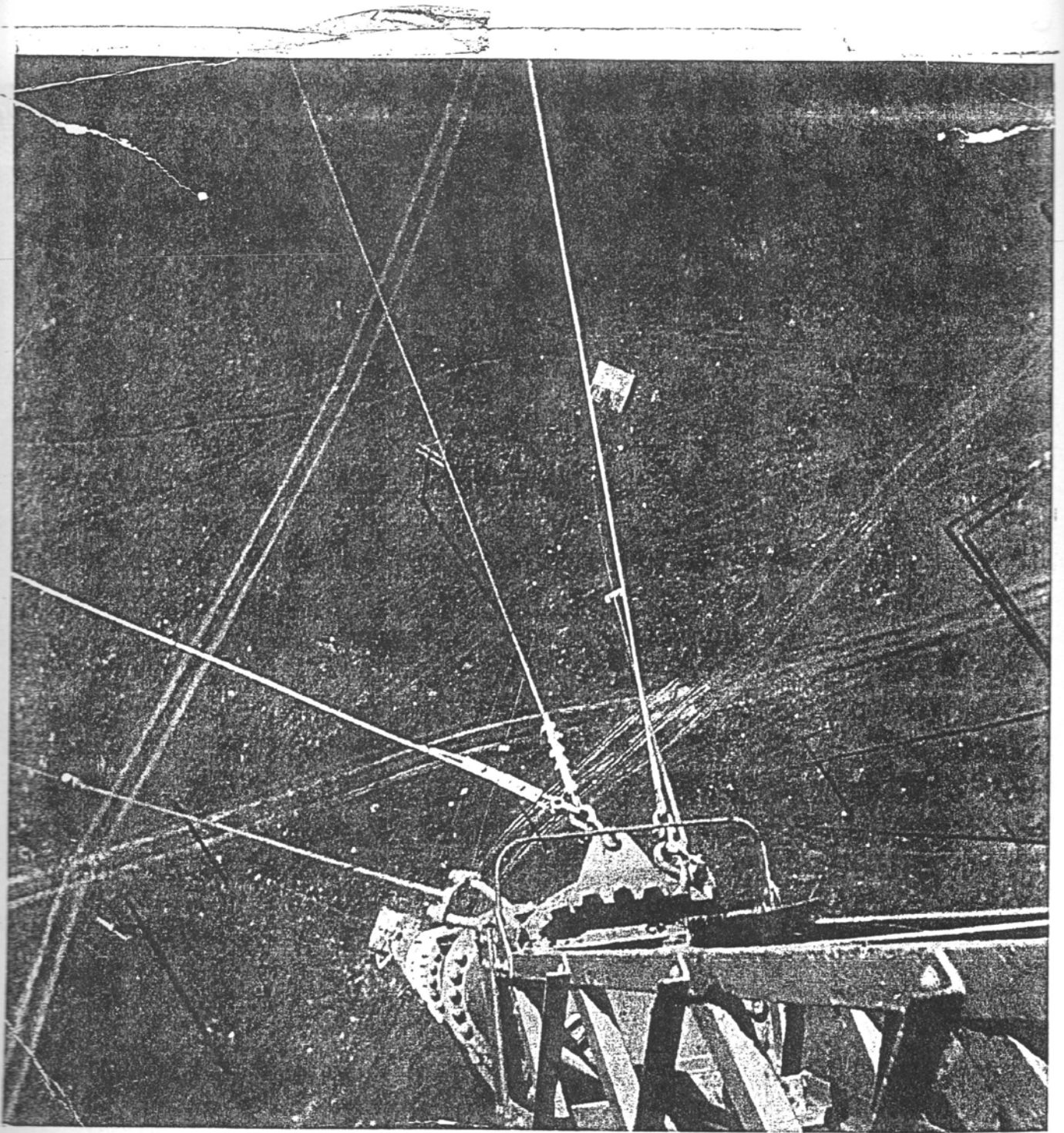

Fig. 310—General Plans of Transmitting Aerials at Marconi Station, Kahuku, Hawaiian Islands.

NOTICE TERMINAL  
END OF AERIALS



TOP OF MAST

U. S. N.

1940

(MAST 1-C)

198



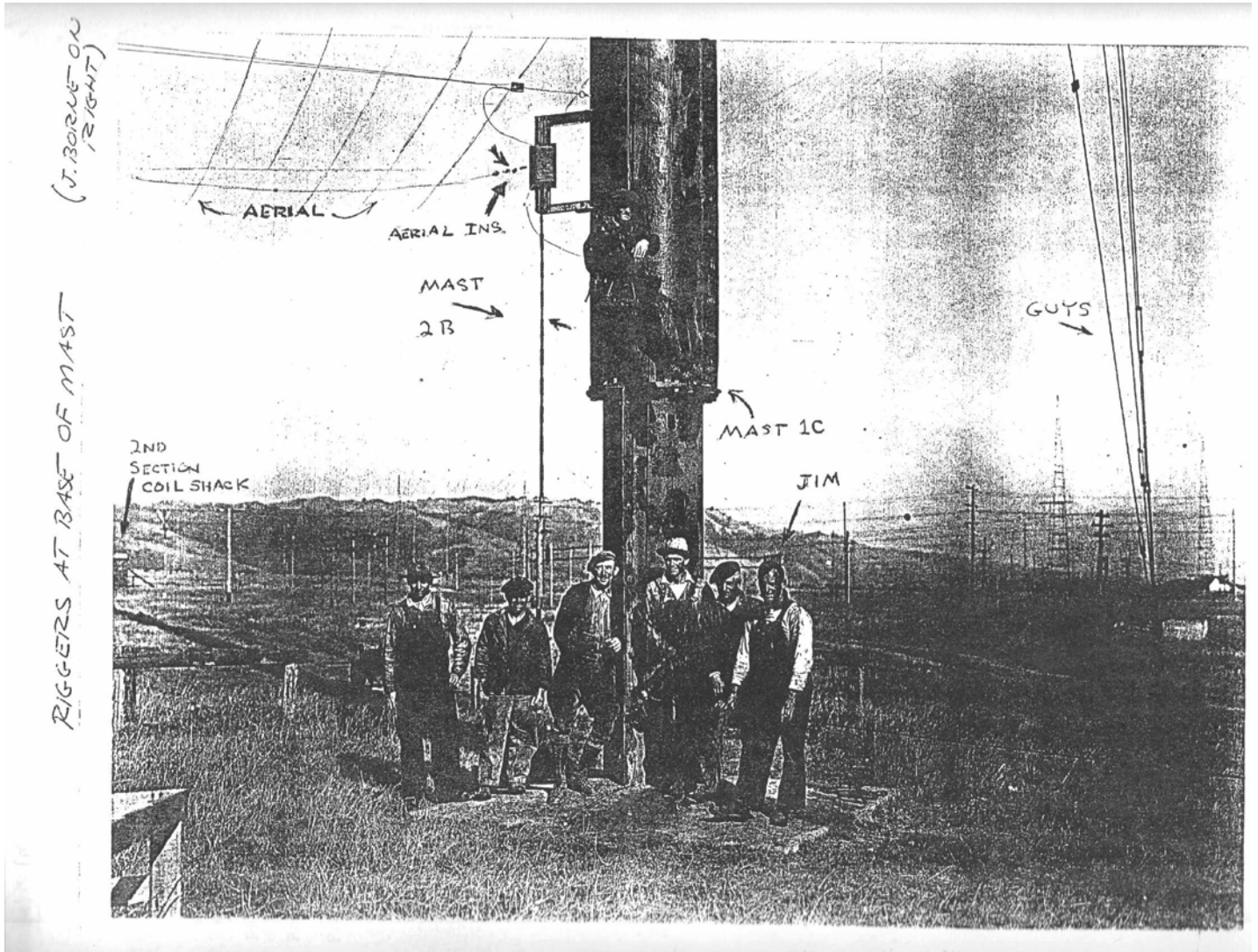



**ENGINEERING NOTICE No.** \_\_\_\_\_

To: CONSTRUCTION DIVISION (15)

Nov. 25, 1957

Copies to: Plant Val. Div. (1)  
Chief Draftsman (1)  
Ass't Chief Eng. (1)  
Mgrs. Eng. Divs. (1 ea.)

Date \_\_\_\_\_ 2

No. of Pages \_\_\_\_\_

Project: Replace Antenna and Aviation Beacon Support

Property Area: Bolinas

Prepared by: J.C. Hepburn *JCH* Approved: *J. J. Tanaka 11-25-57*

I have directed to your attention DWGS:

A-1,313,371 Location Plan Marine IF Antenna  
 B-1,334,436 Ground System Detail: Marine IF Antenna  
 E-1215 Ground System: Long Wave Antenna

These drawings locate the new 300 foot tower and specify the modifications to the ground system.

The location of the tower is based on the assumption that Dwg. E-1215 is correct. To assure that the tower is located midway between the existing bonding wires, the bonding wires should be unearthed where they cross the base line 8' & 208' (approx.) east of Monument B. The parallel coordinate is to be halfway between the bonding wires (approximately 108' east of "B"). The perpendicular coordinate is to be located by unearthing the first 7/24 ground wire south of the base line (approximate 11.75 feet South) and locating the tower center halfway between the base line and this ground wire.

8 Additional #14 AWG ground wires are to be installed midway between the existing 7/24 wires. All ground wires are to be bonded to four #8 AWG radials as shown in the drawings.

If the location as calculated above differs from that shown on A-1,313,371 the field is to advise the writer.

The guys are to be located approximately as shown on A-1,313,371. The northerly guy is to clear the buildings by five feet and the other guys are at 120° intervals. The field is to supply the distances x+y from the anchors to the center of the road along the guy lines as soon as possible so we can determine clearances.

807016

EN No. \_\_\_\_\_



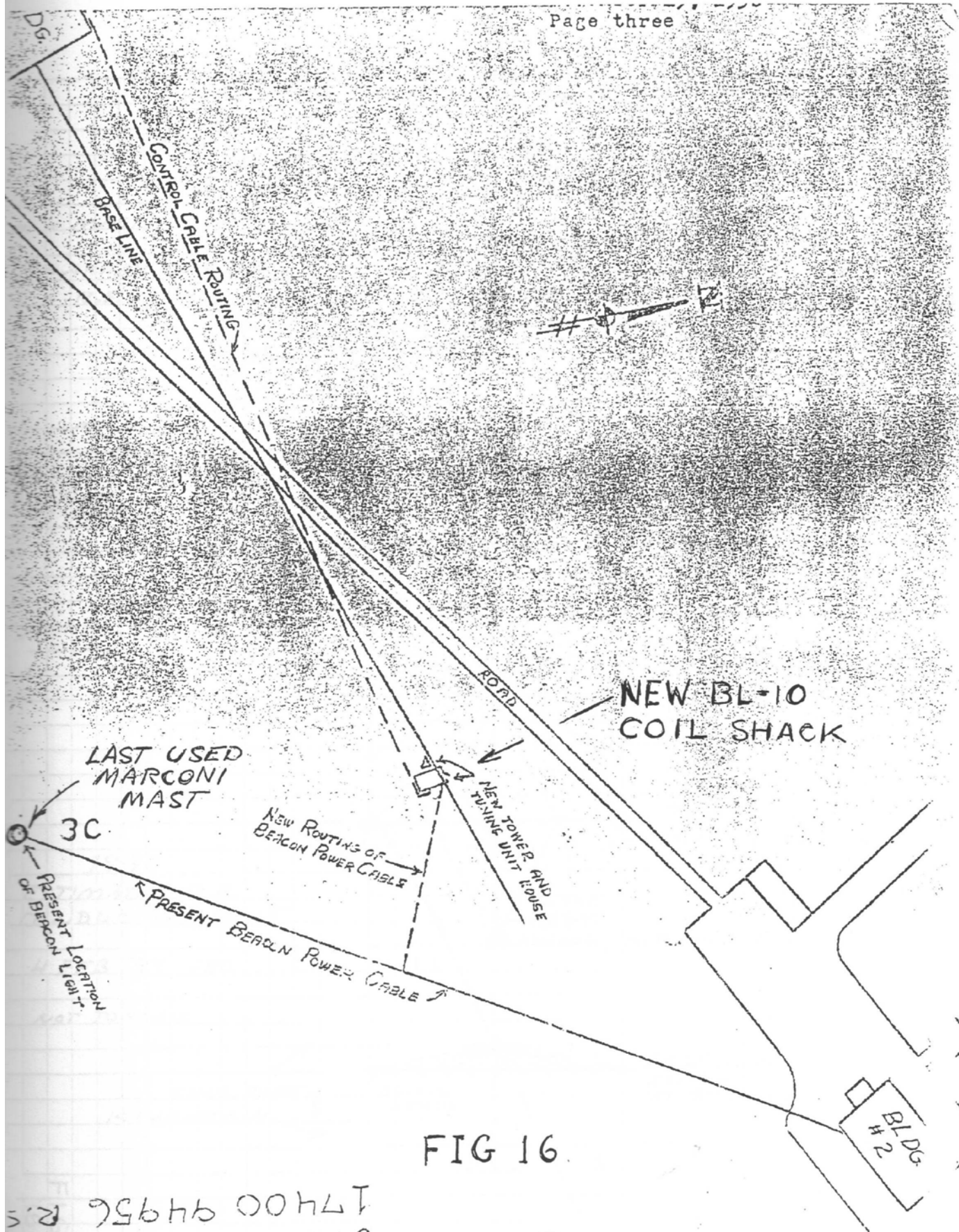

FIG 16

3970187  
17400 94956 P.S.

EN-807016-12

B. F. K. K.

23



1953

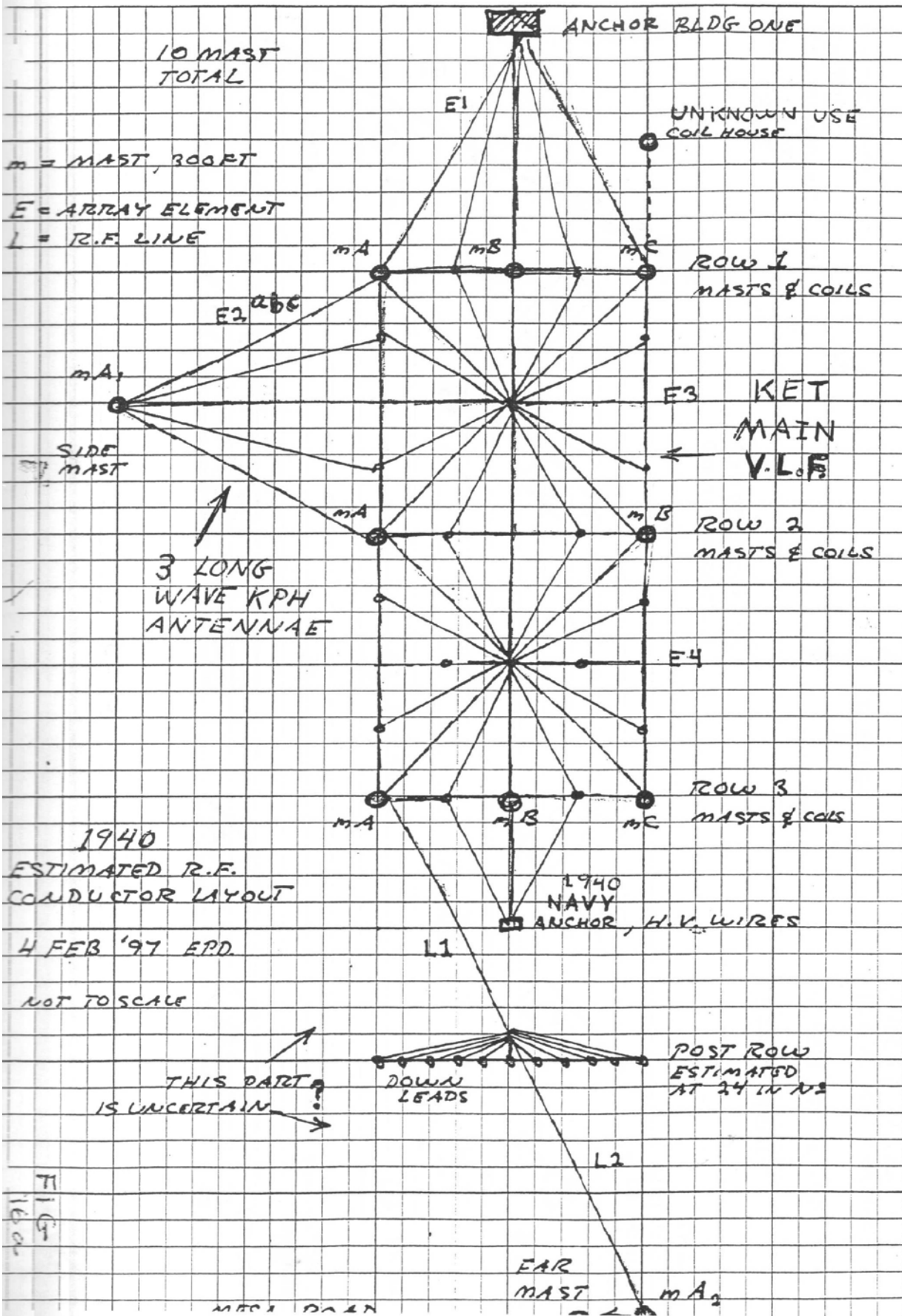
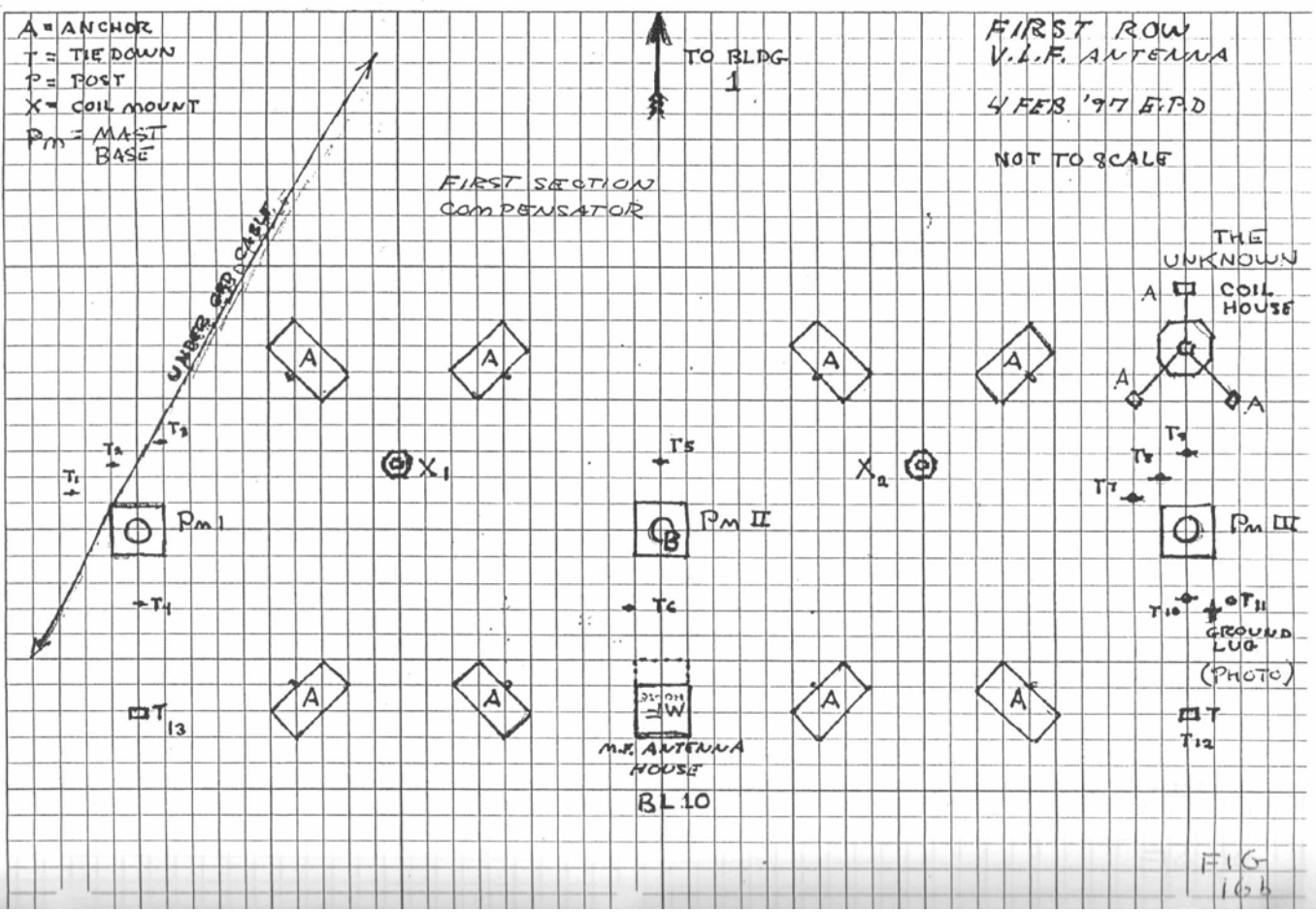

FIG 16a



2 FIG 16

1



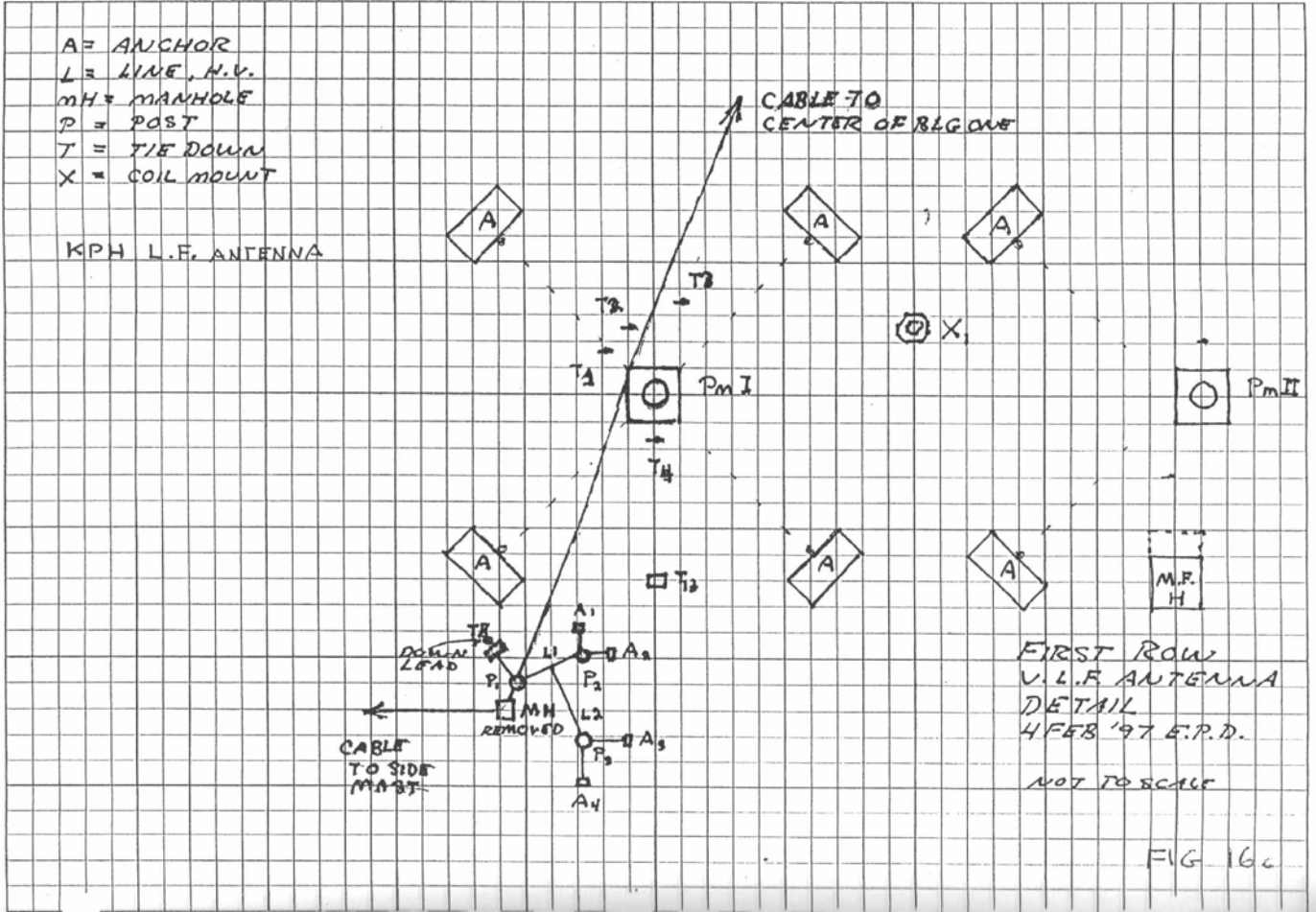



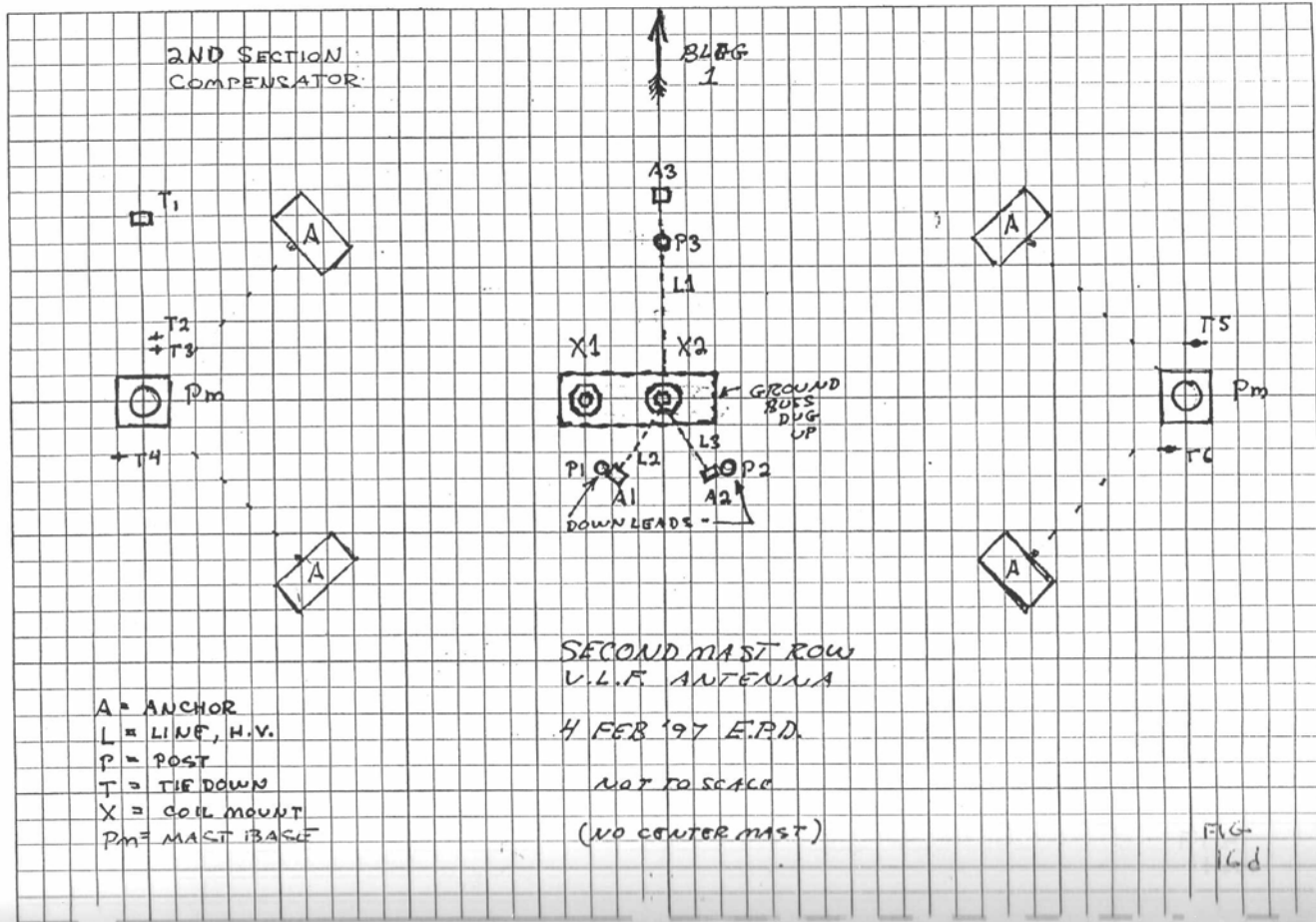

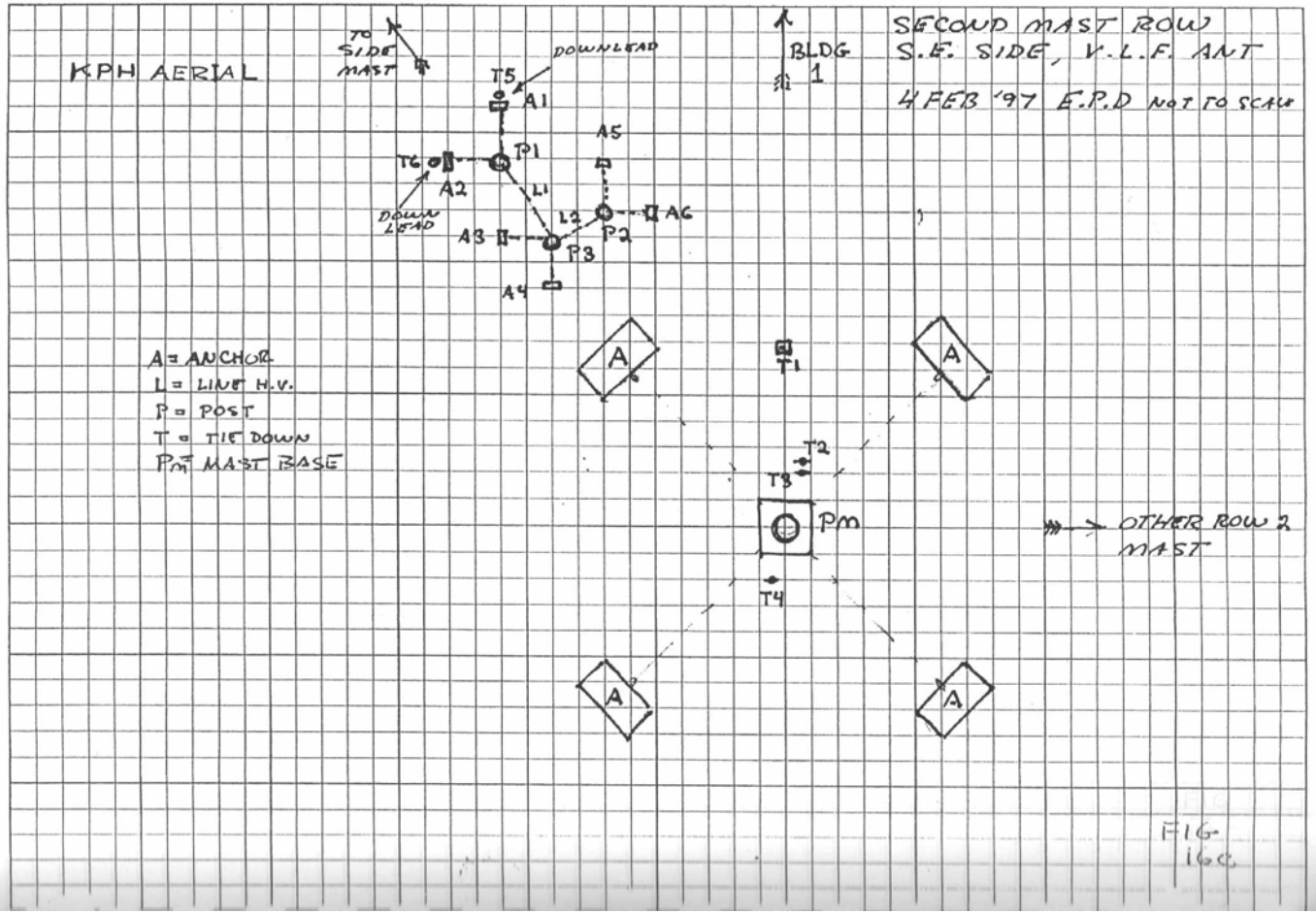



6

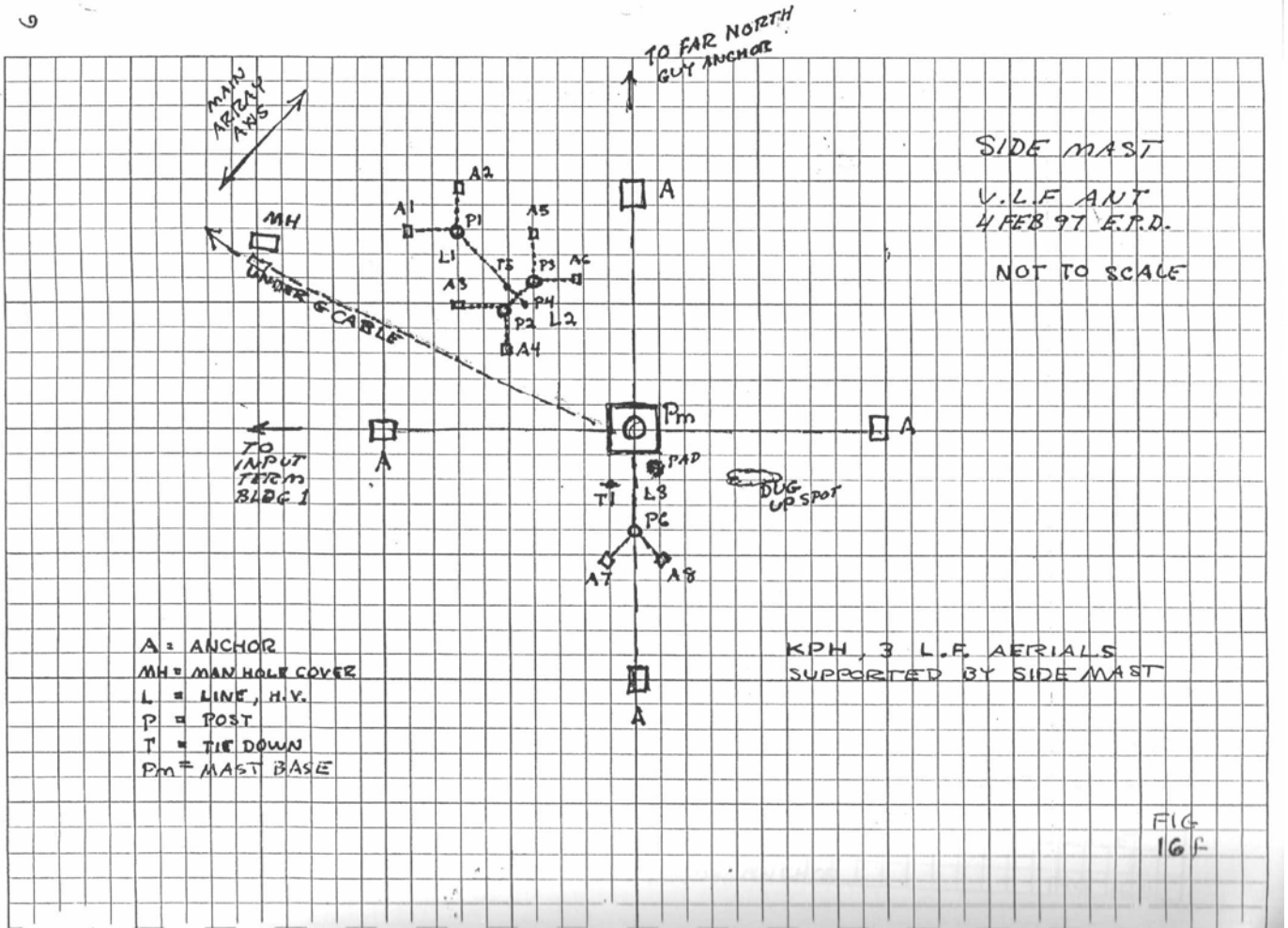

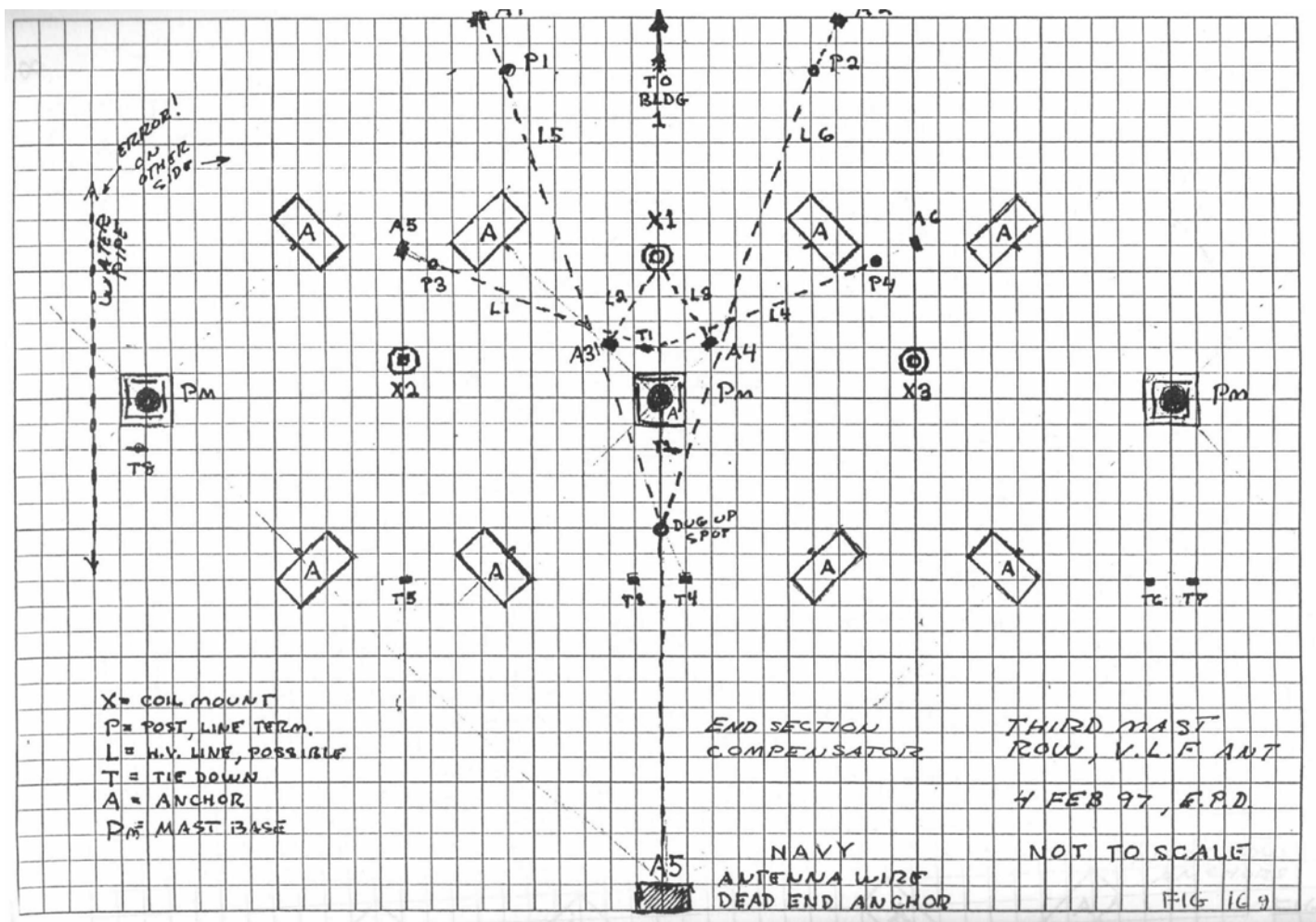



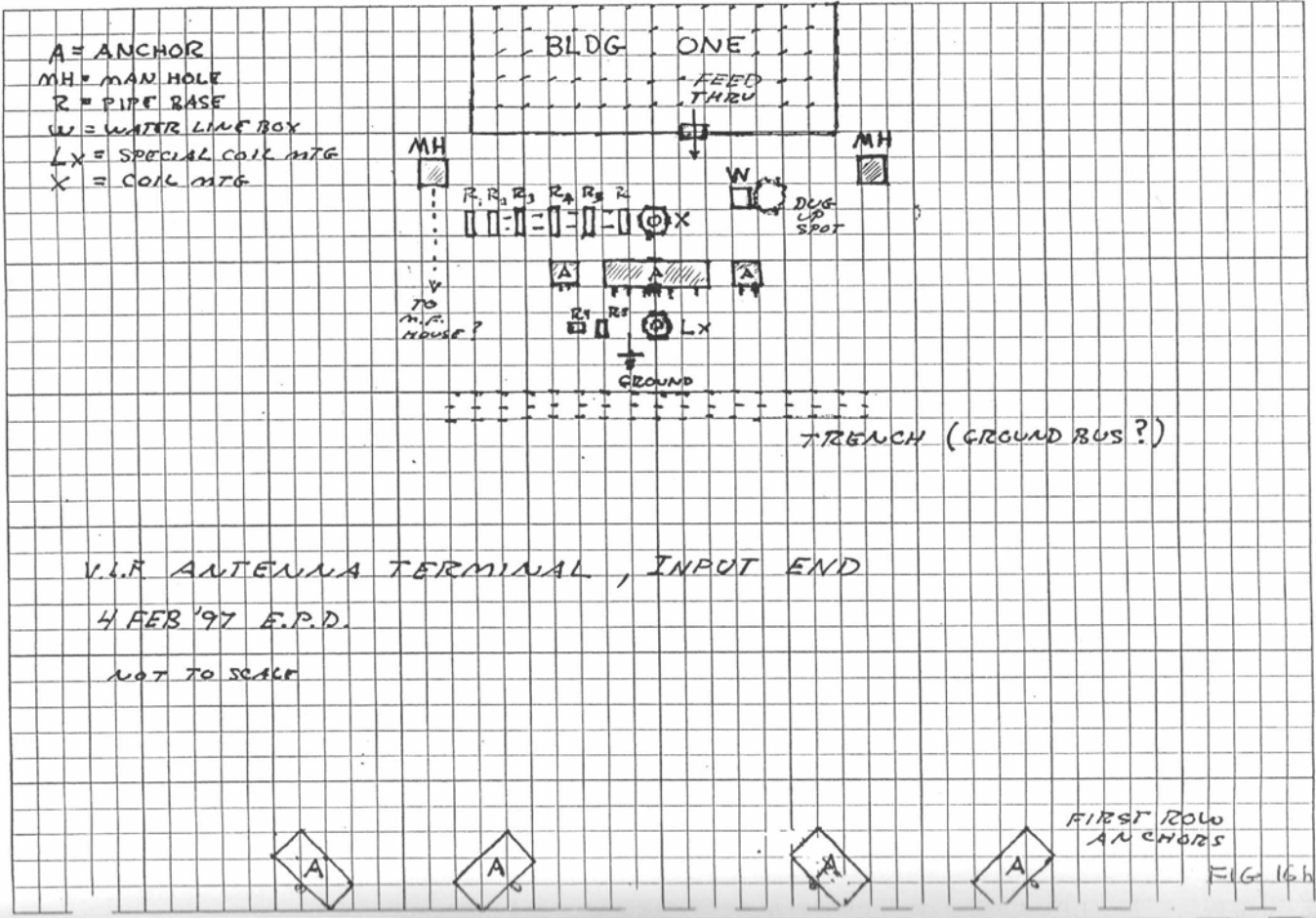

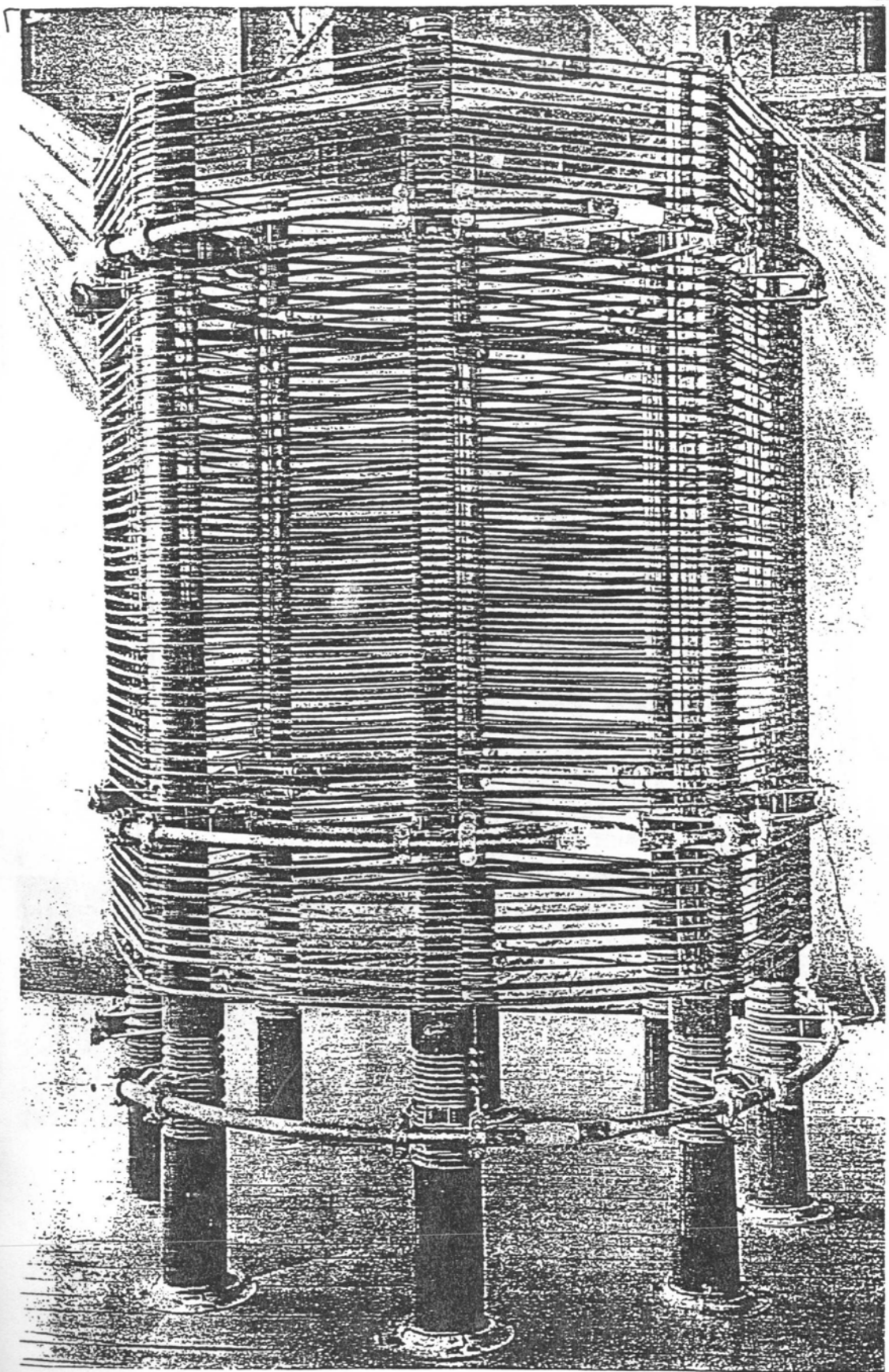

SERIES  
COIL

FIG. 17.

Tuning Inductance for Multiple Tuned Antenna.



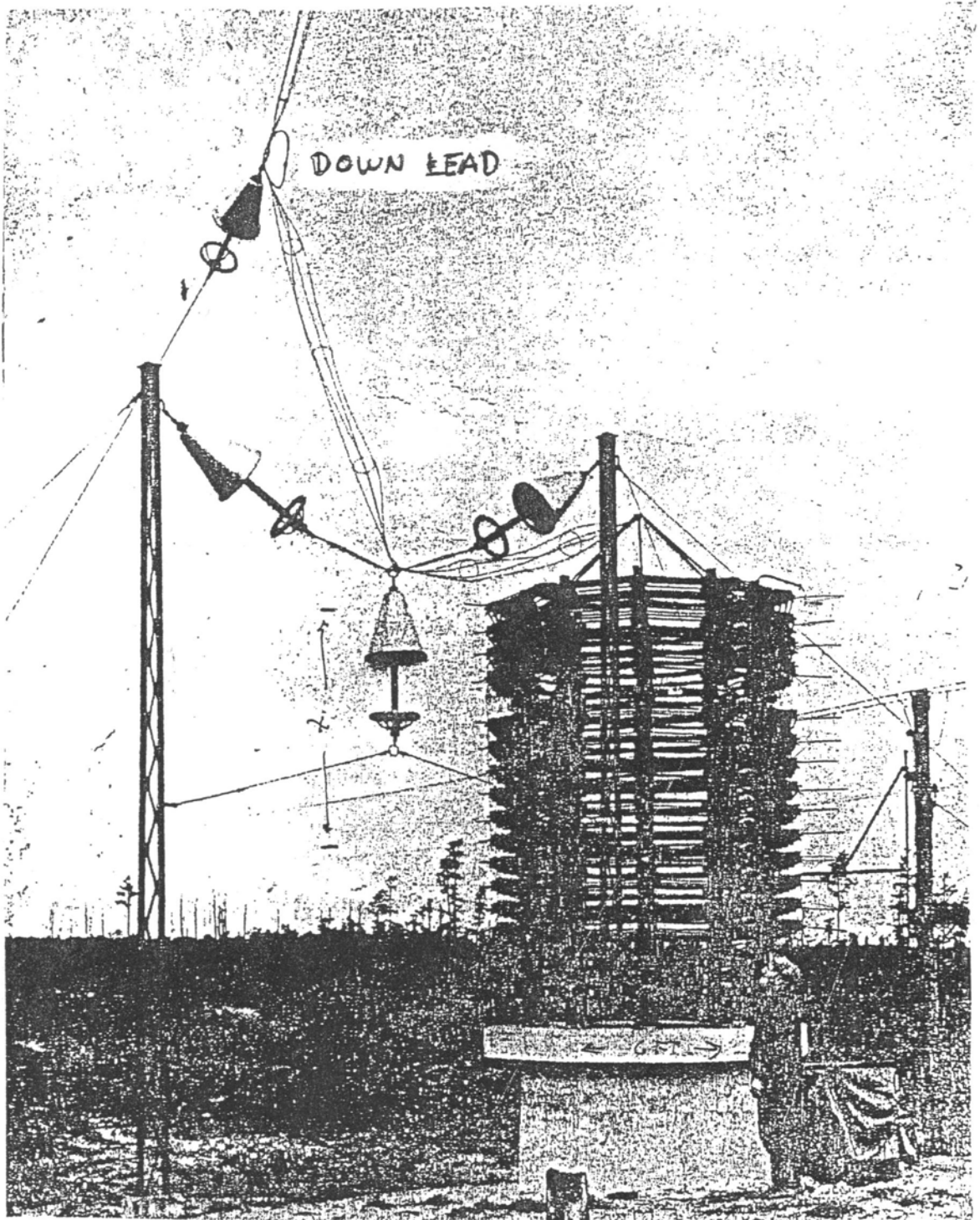

SHUNT COIL

FIG 17

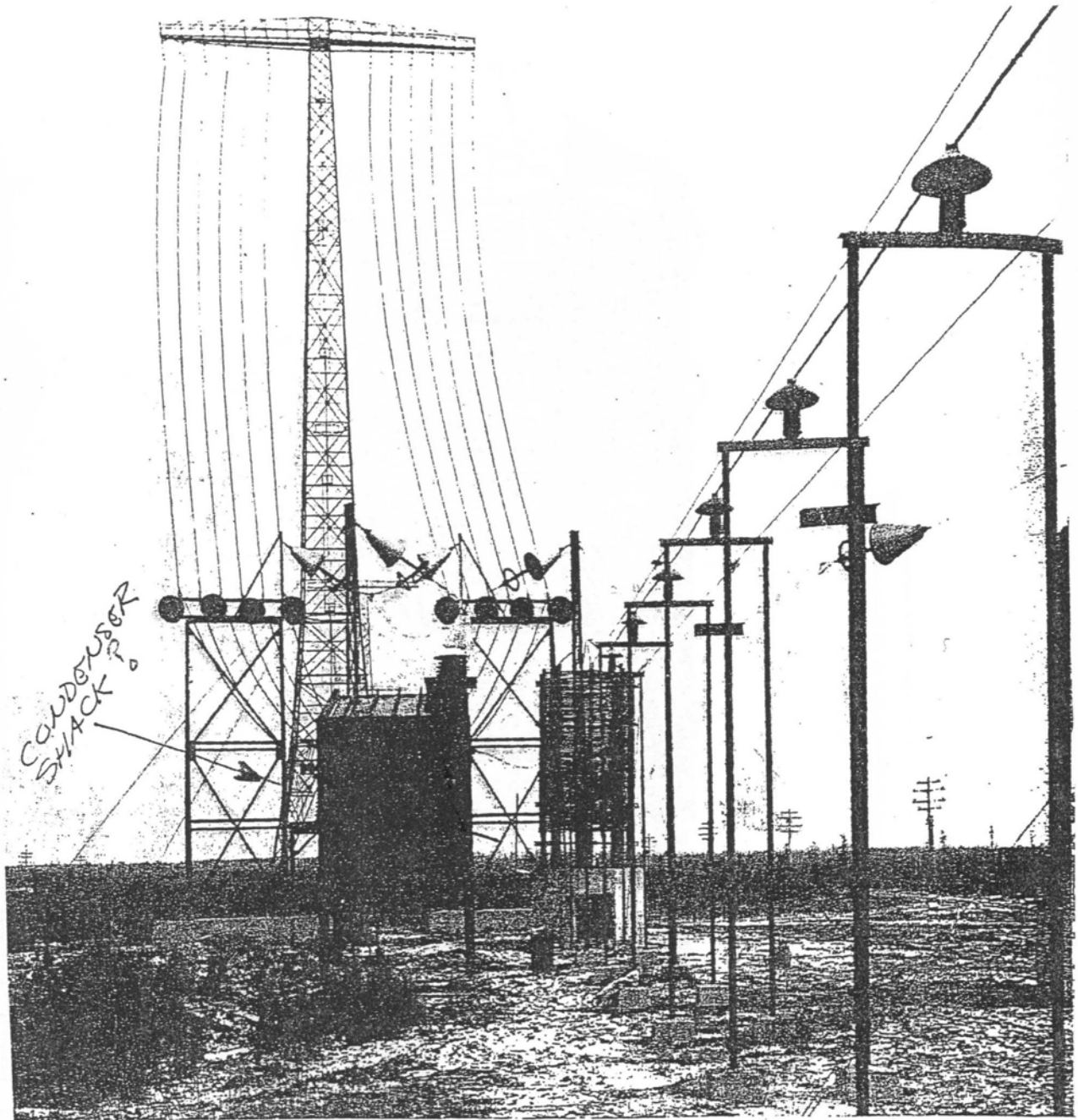

CONDENSER  
SHACK

FIG 18A



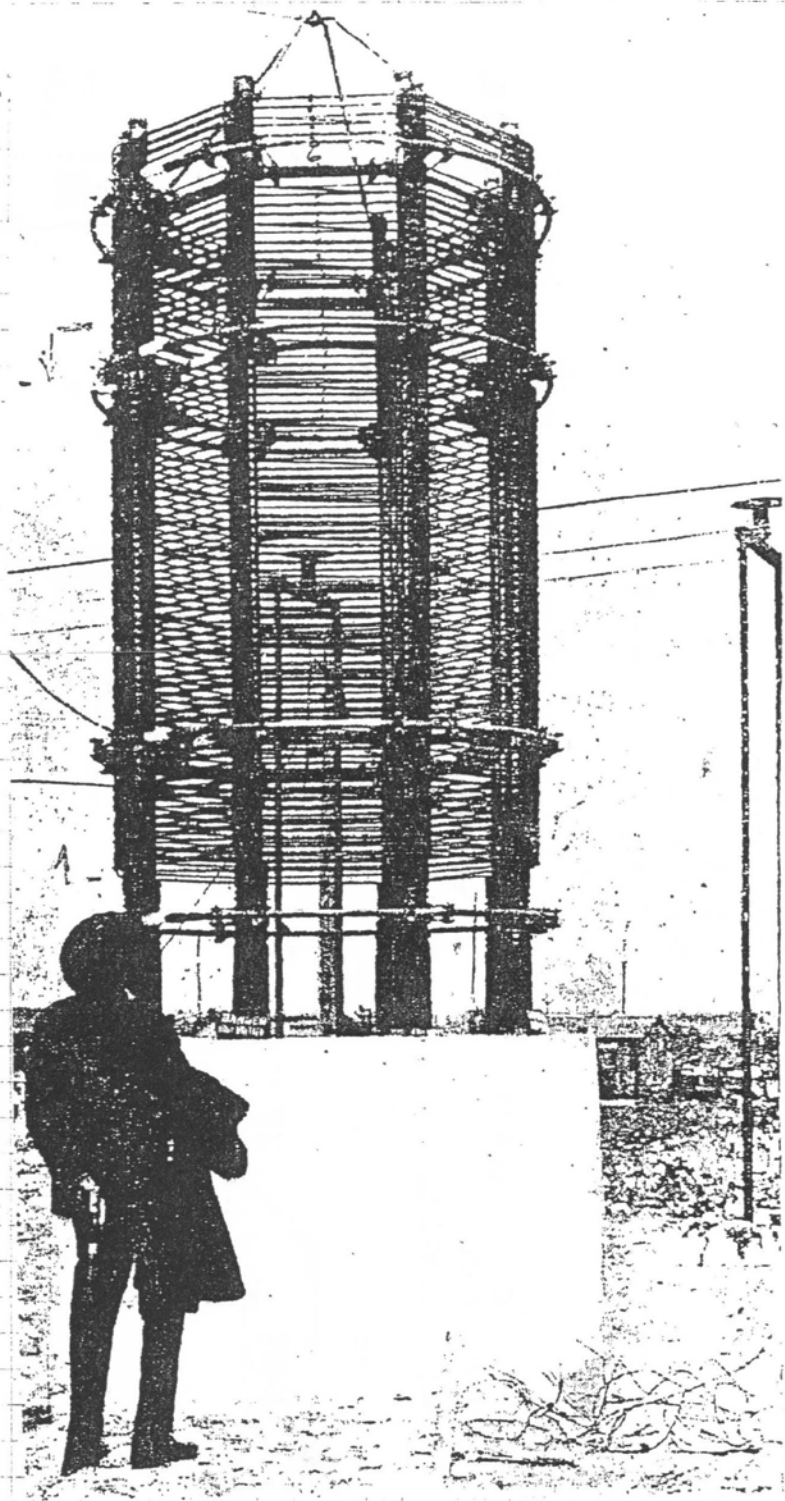

SERIES COIL FIG 18

HH

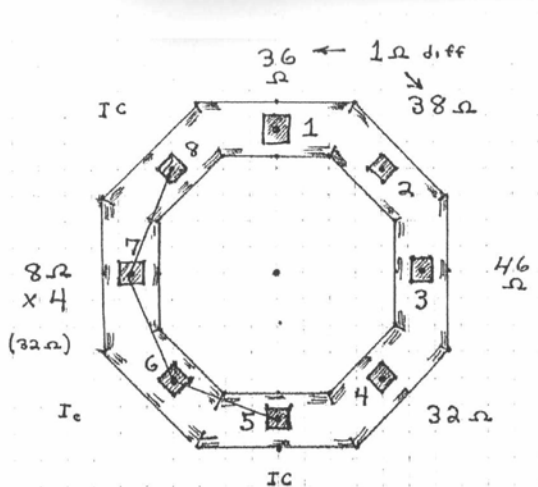

LEFT FIRST SECTION SHUNT COIL BASE

THIS SECTION BASE NOW CONNECTED IN TANDEM FOR 5 OHM TOTAL CONDUCTIVITY IN PREPARATION FOR TESLA EXP.

↑  
BLDG ONE

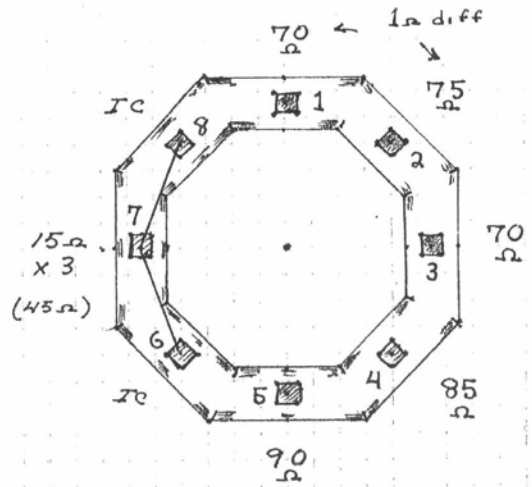

RIGHT FIRST SECTION SHUNT COIL BASE

↓  
TOWER HOUSE

COIL MOUNT STUD CONDUCTIVITY TO CENTRAL STATION GROUND



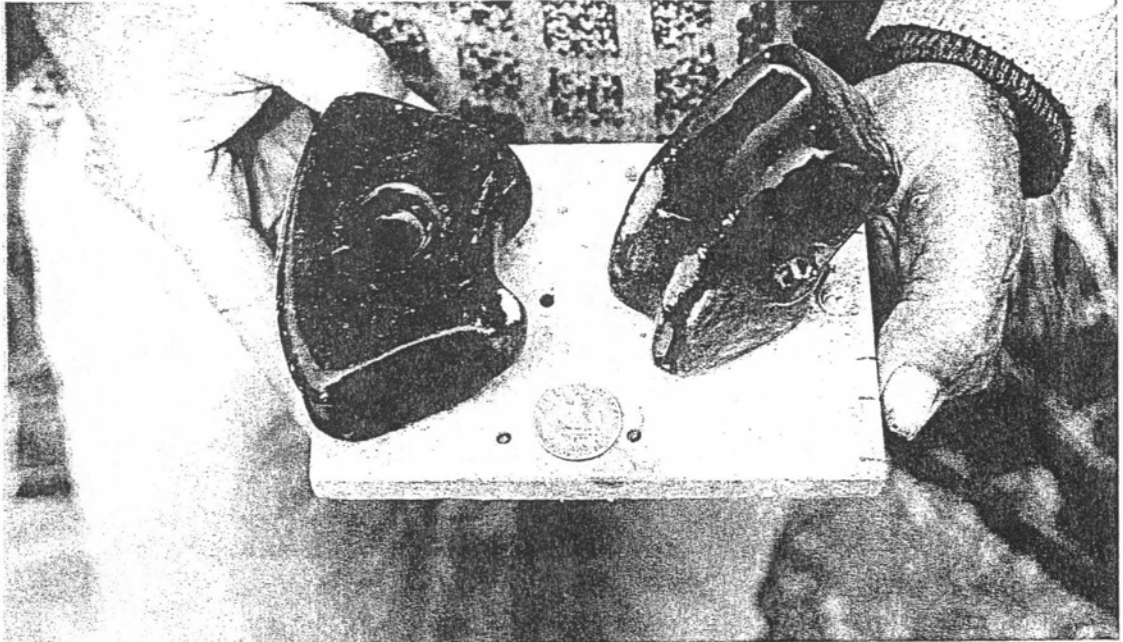

PTB/ Fig. 18B: series coil sectional insulators

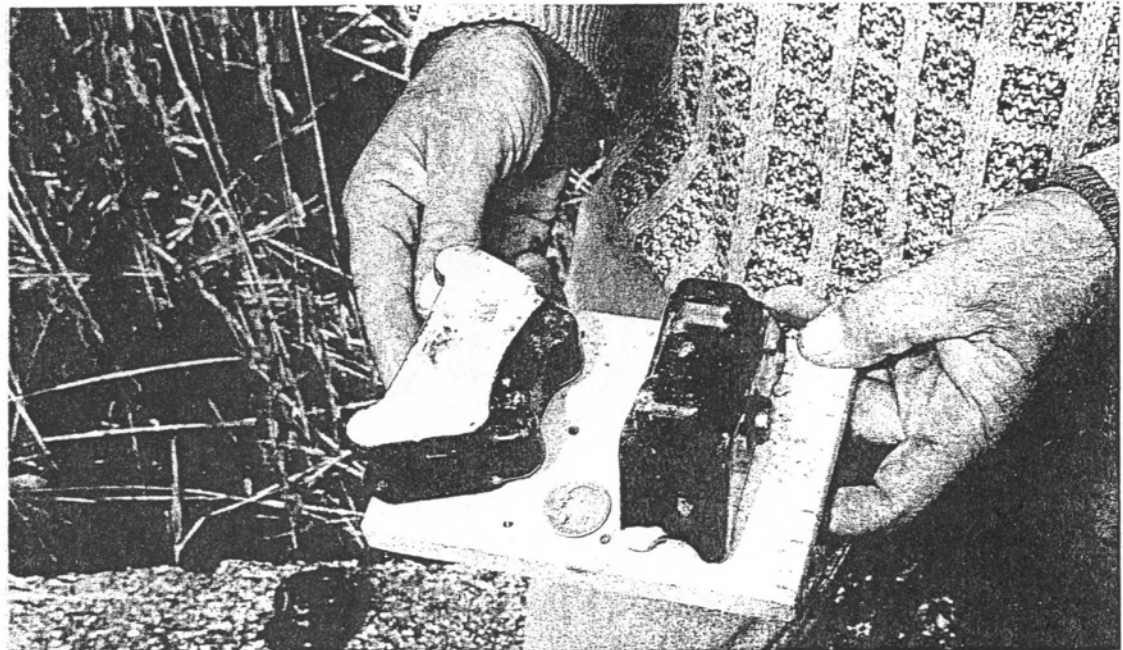

PTB/ Fig. 18A: series coil sectional insulators  
low capacitance



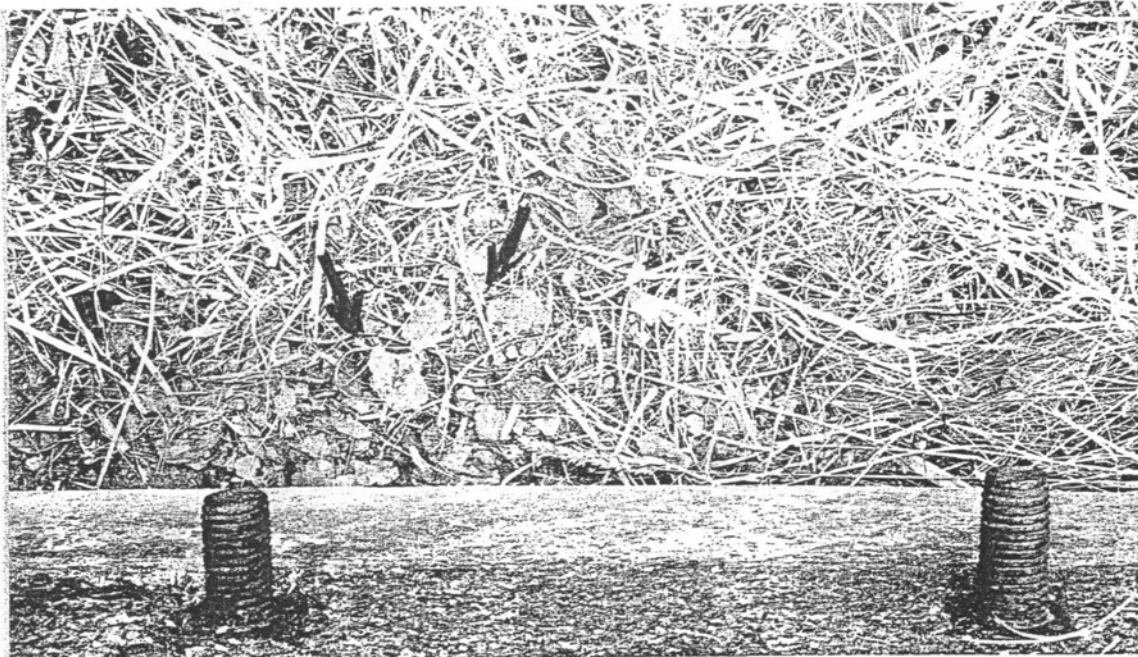

PTB/fig.16A: mica breakage at input section



PTB/fig.16A: coil mounting base



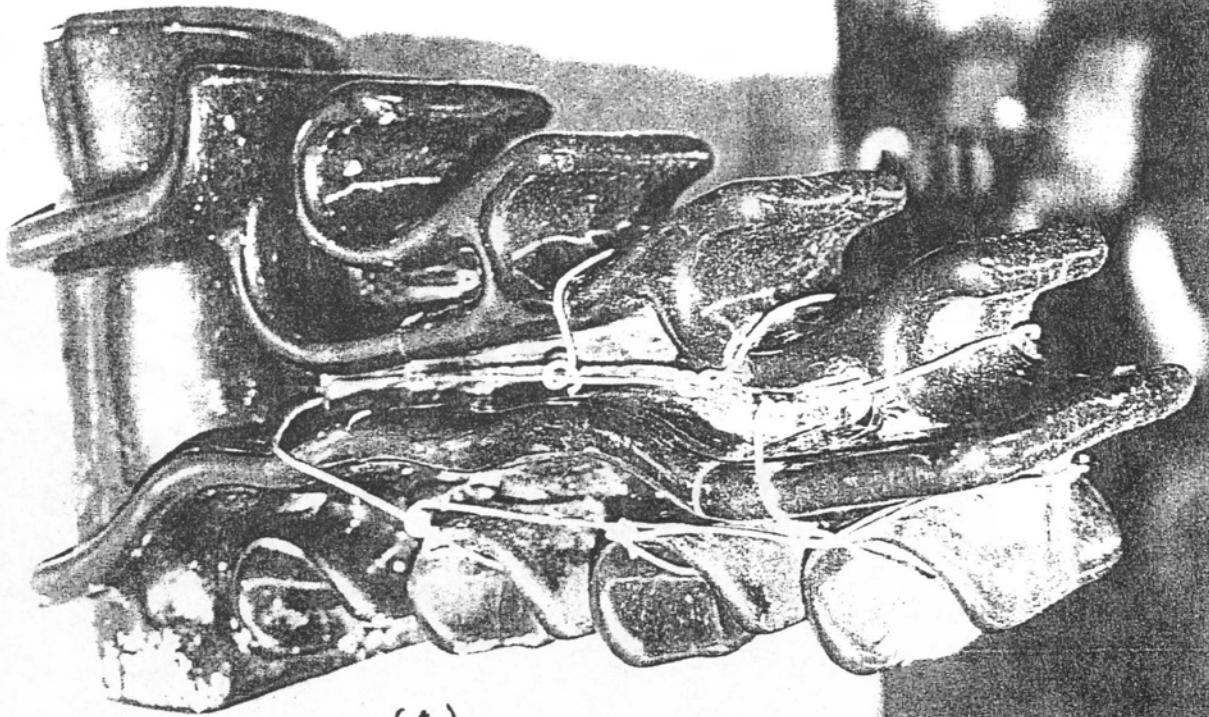

(1)

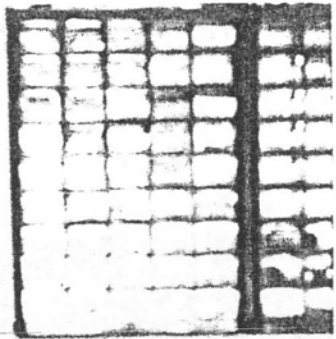

SHUNT  
COIL  
INSULATOR

1) AS MOUNTED

2) TOP VIEW

3) SIDE VIEW

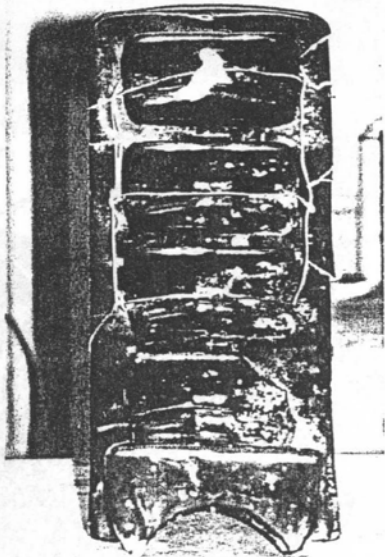

(2)

FIG 22

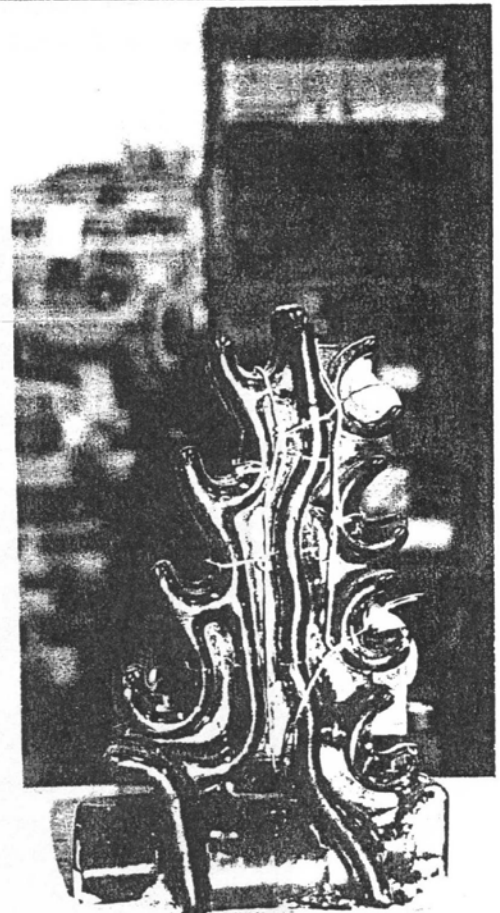

(3)



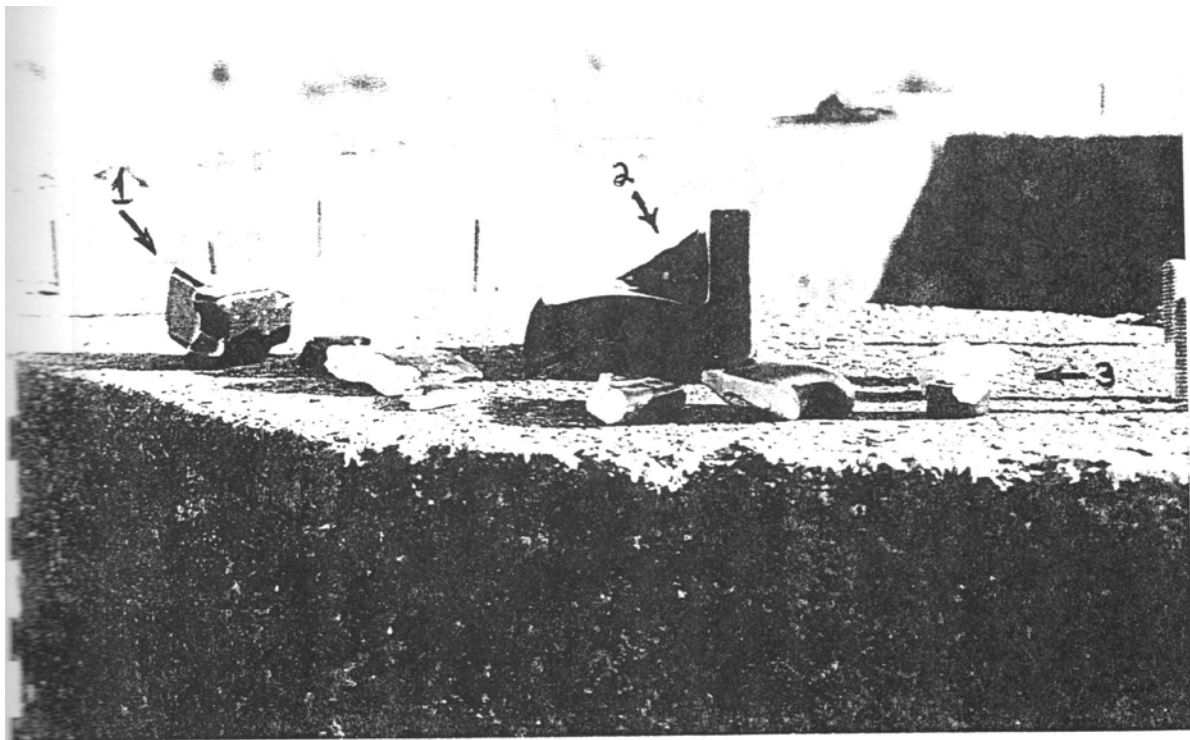

INPUT  
SECTION  
BREAKAGE



1) SERIES COIL

2) SHUNT COIL

3) CONDENSER



END  
SECTION  
BREAKAGE

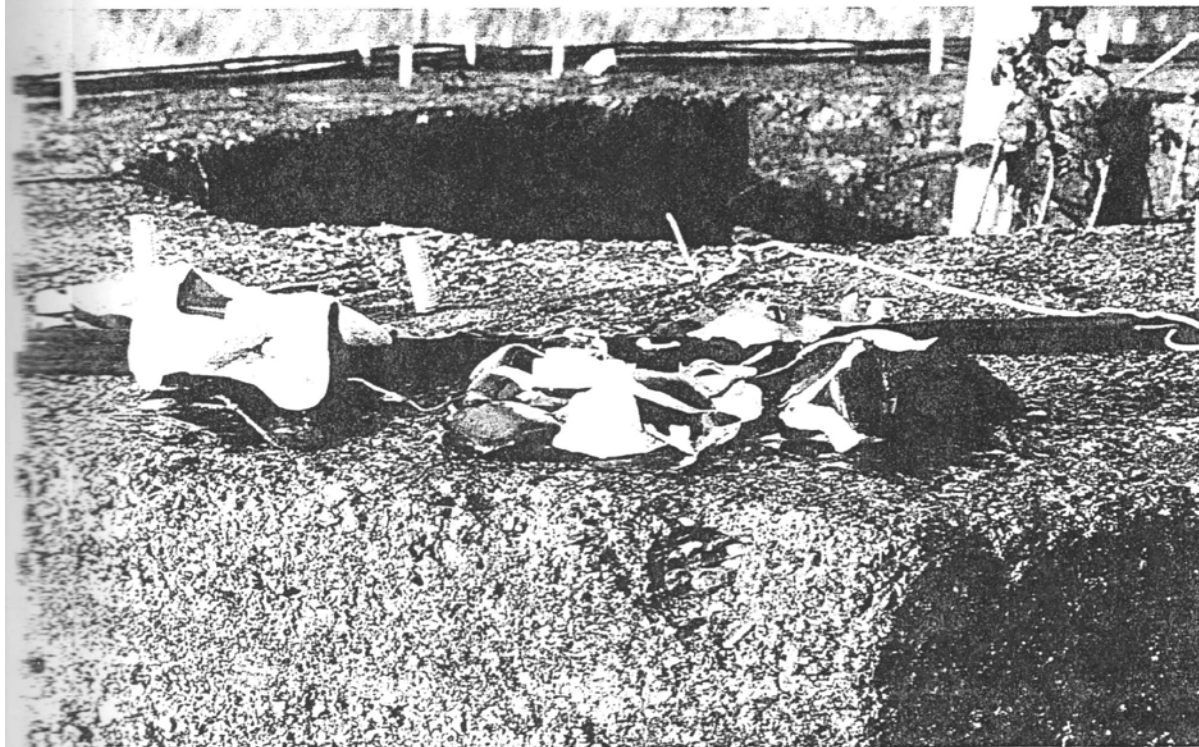

CONDENSER BREAKAGE



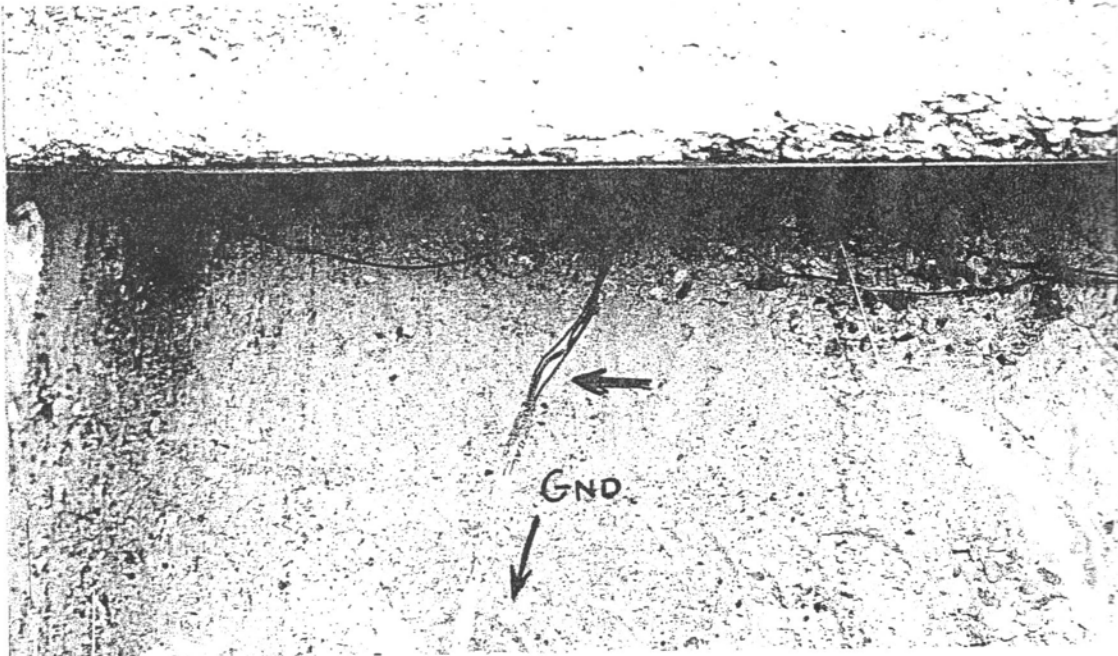

PTB/ Fig. 21: #8 wires to ground

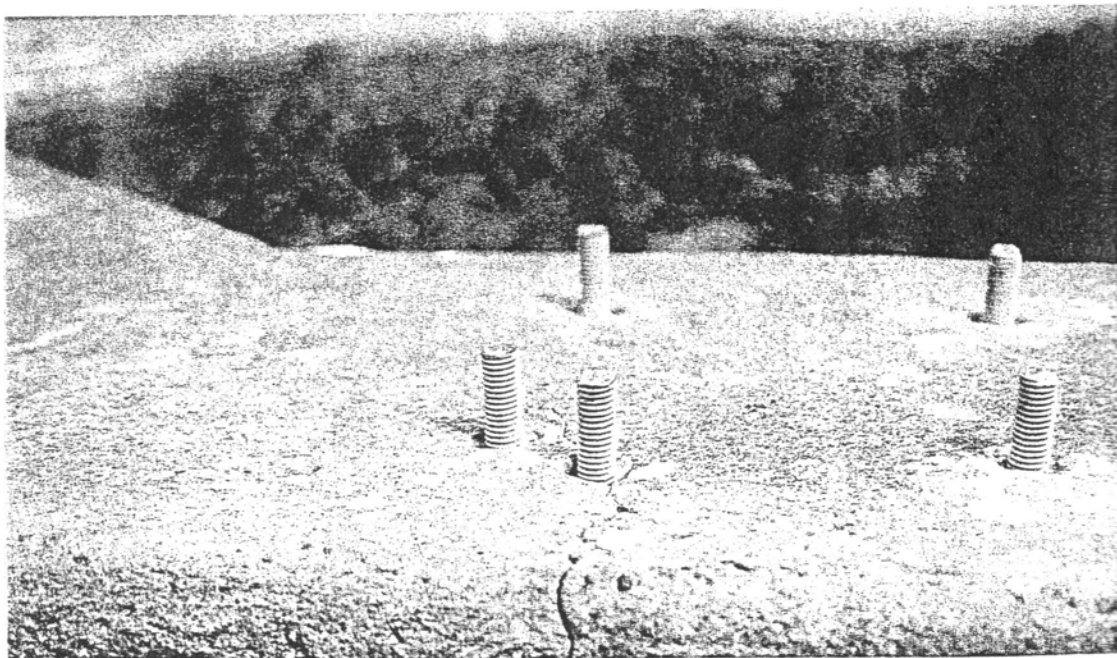

PTB/ Fig. 20: bronze studs



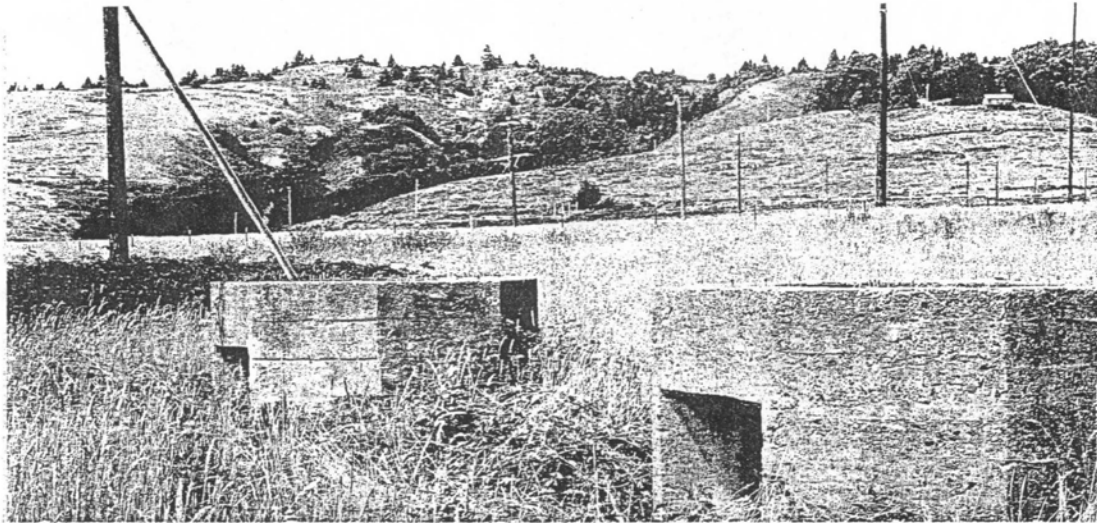

PTB/ Fig. 22 : Second section



PTB/ Fig UNKNOWN coal shack Foundation



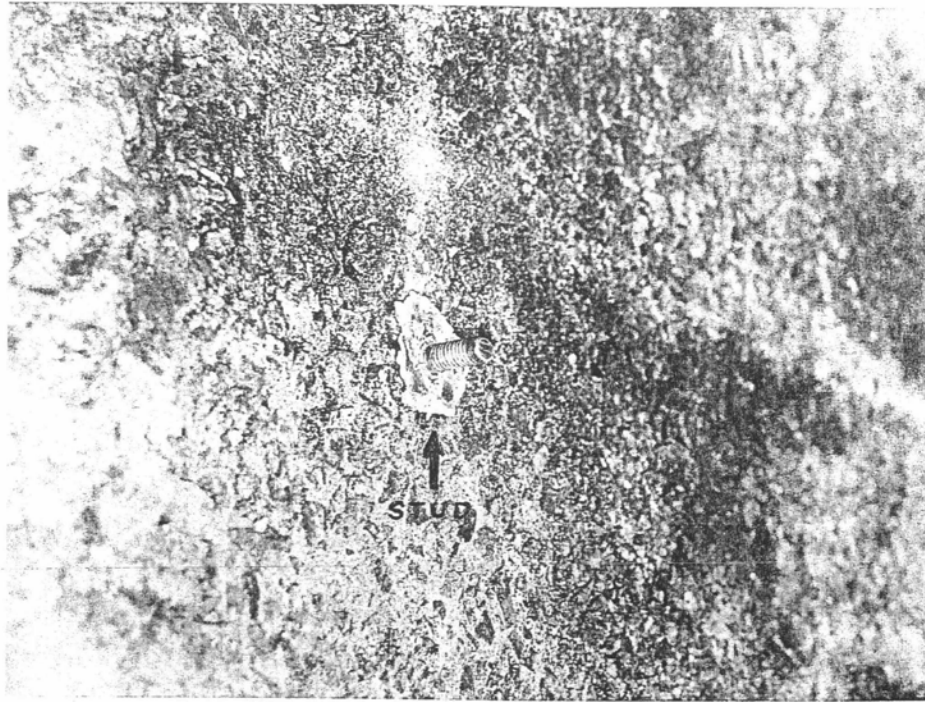
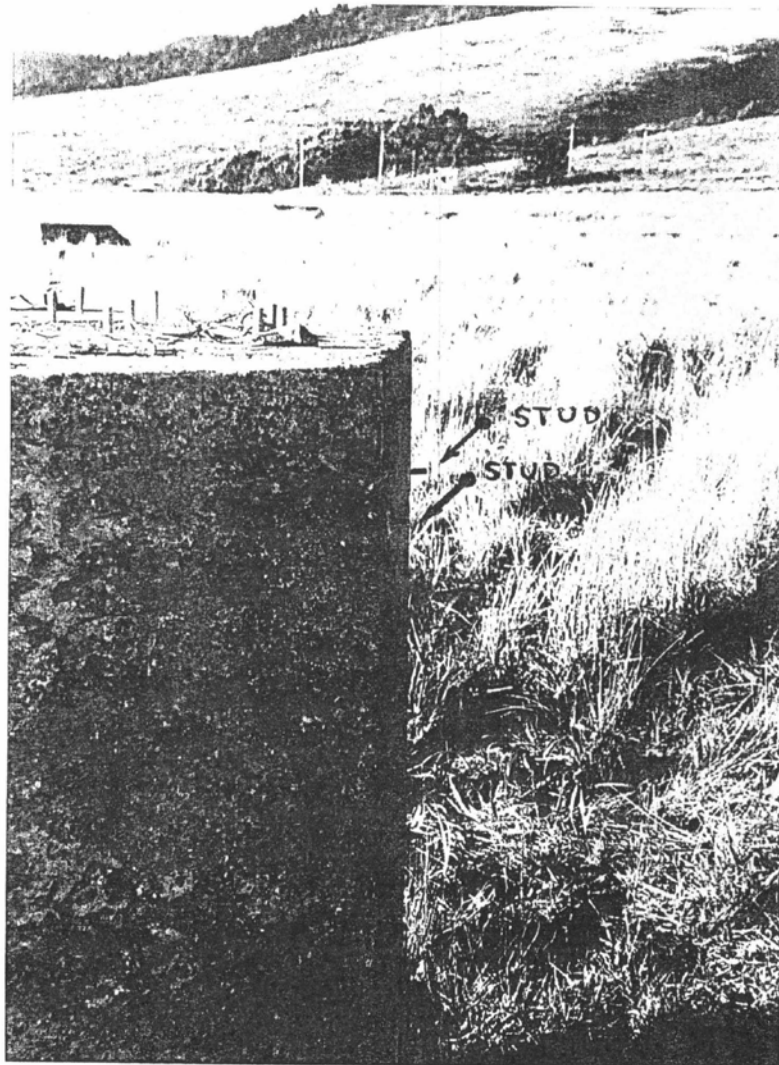
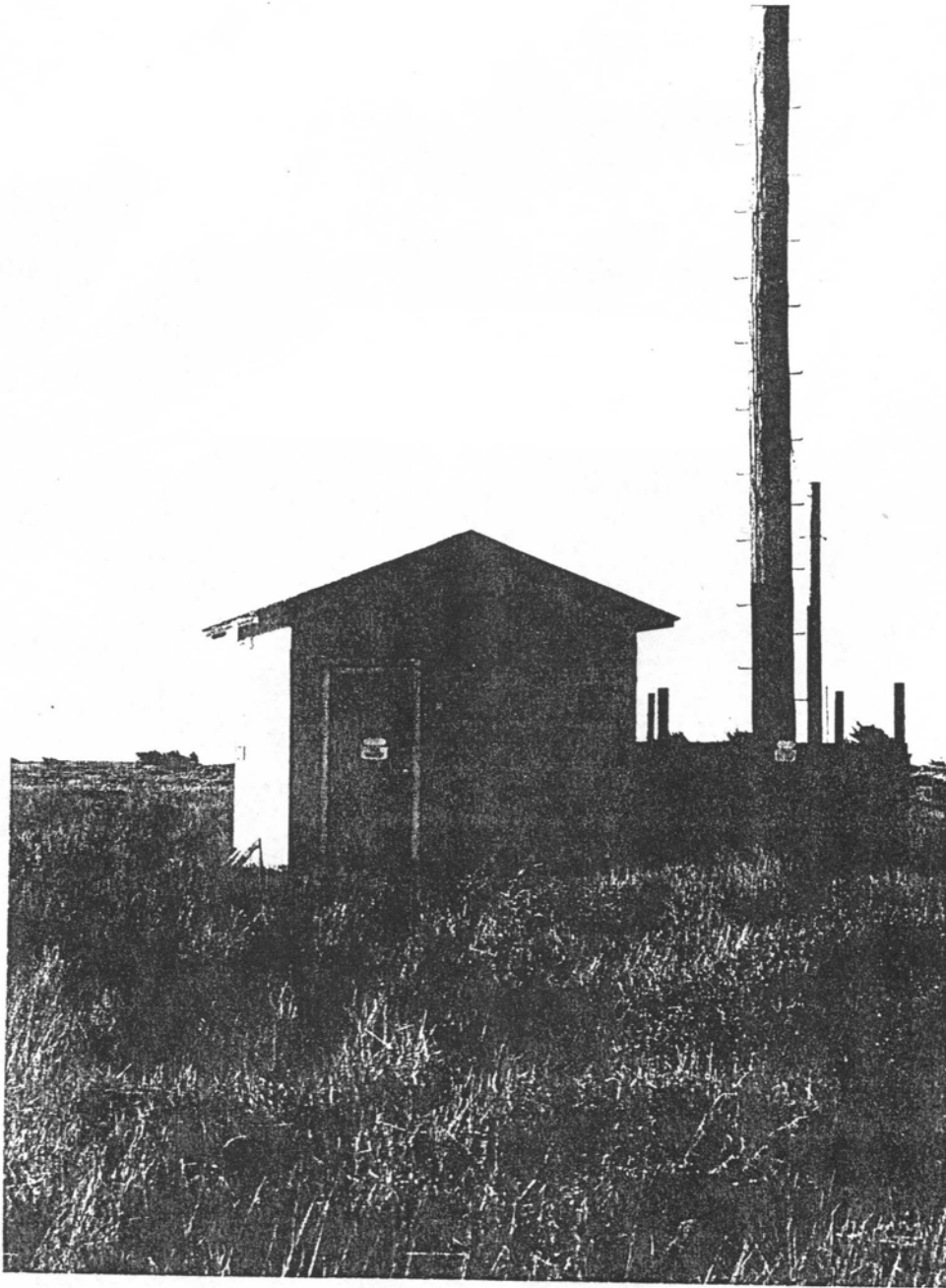

FIG 22 A SERIES COIL OUTPUT POINT





MEDIUM FREQUENCY  
COIL SHACK (BL-10)  
(KDGOSX)



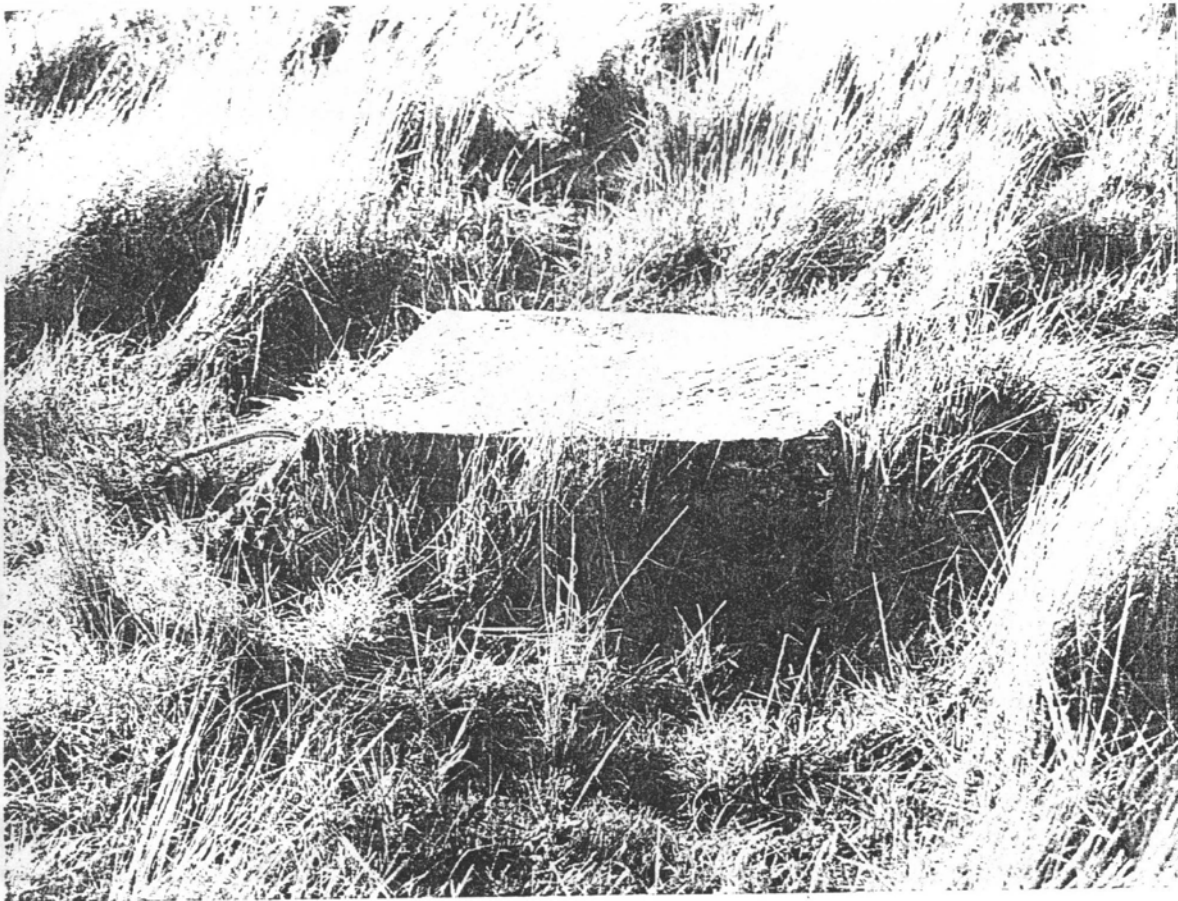

FIG  
27



FIG  
28



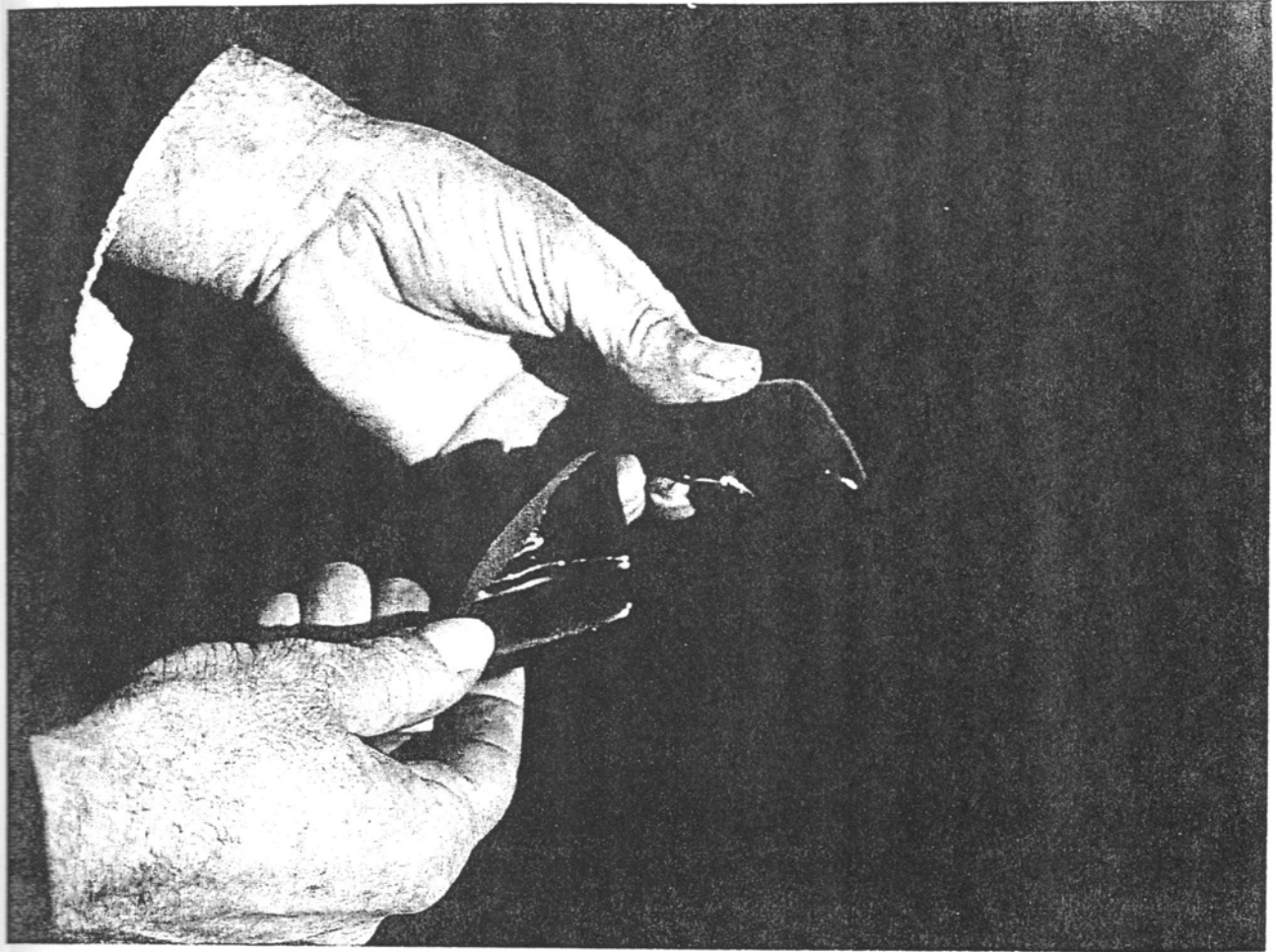
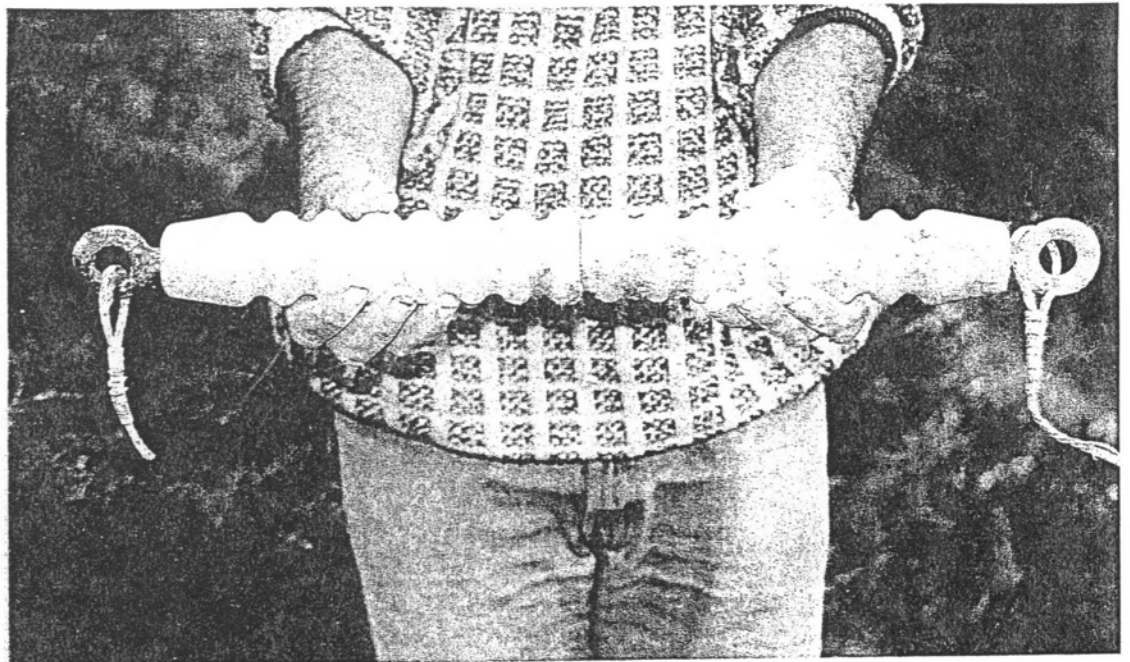

FIG 20A





PTB/fig. 37 E : First KPH insulator 126 KC



PTB/fig. 37 D : unknown shack Foundation  
Series coil insulators  
stacked as in use



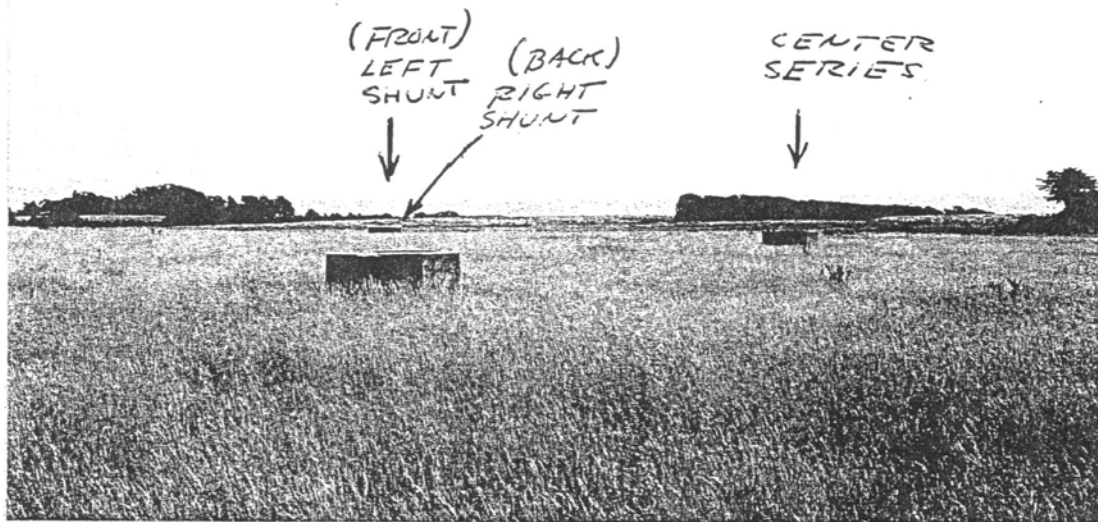

PTB/fig. 25: third section (END SECTION)

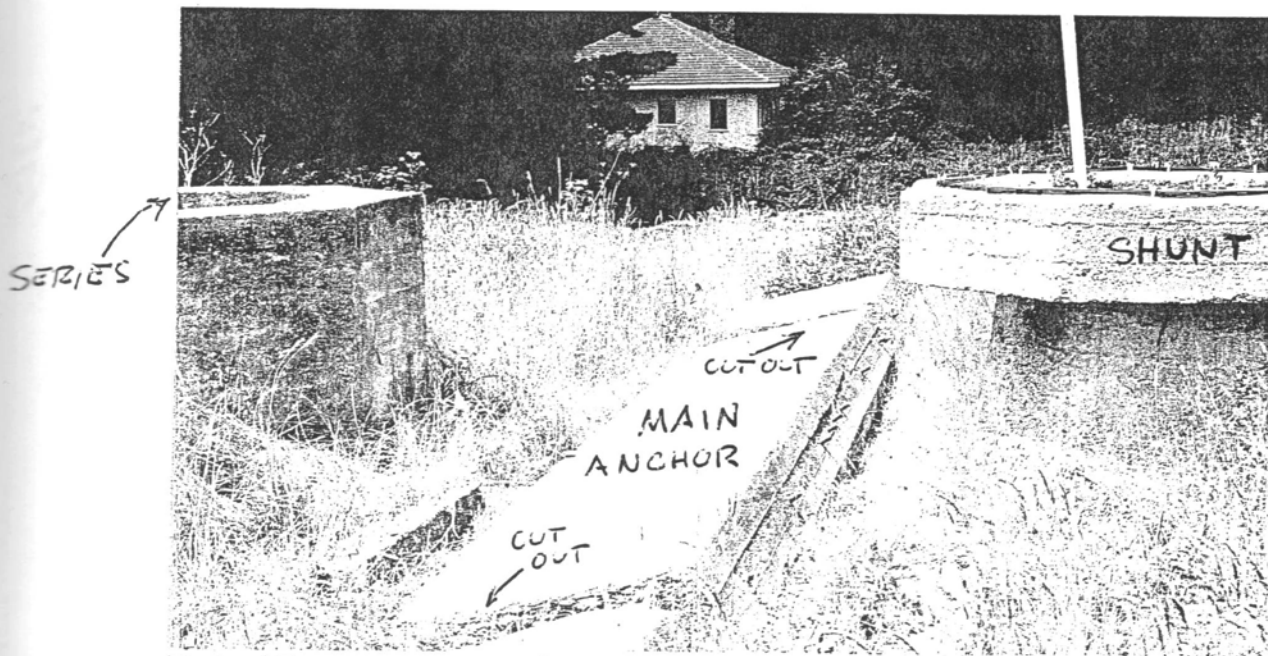

PTB/fig. 29: input section



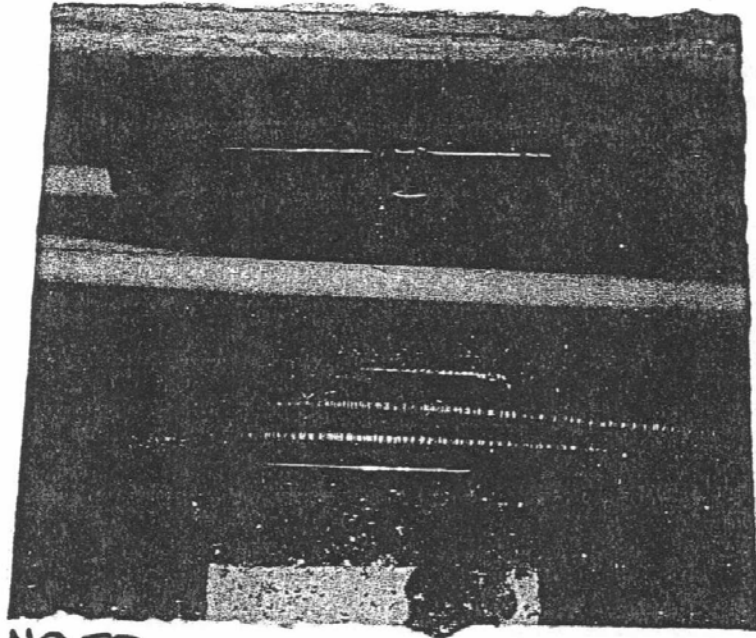

NO ID

UNDER GROUND  
12KV POWER CABLES

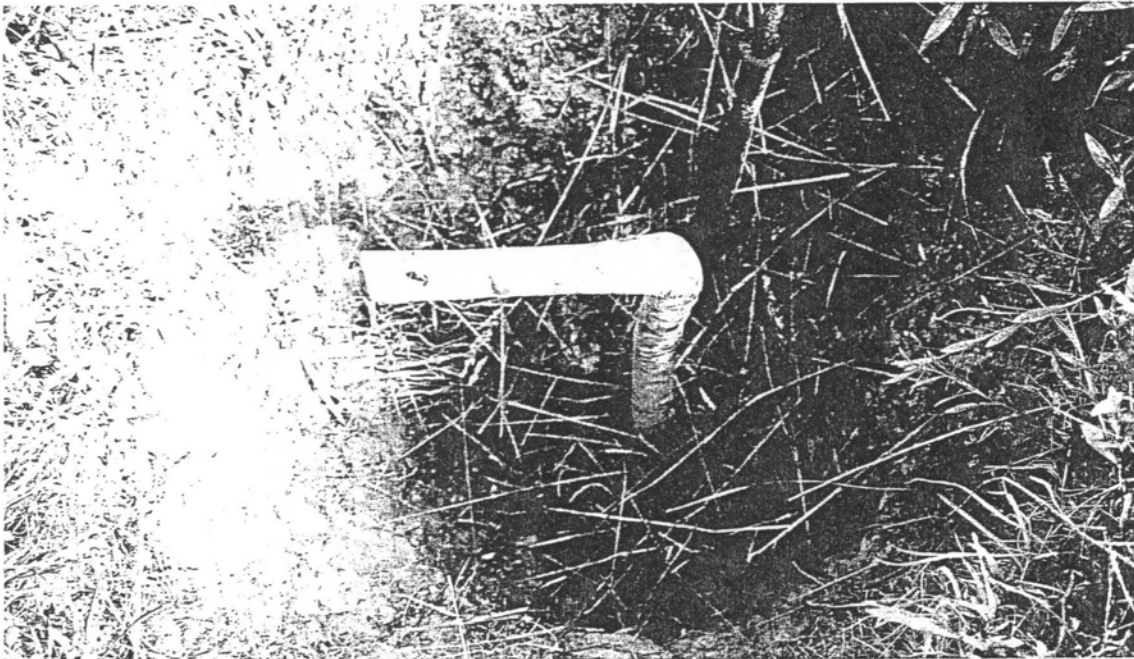

PTB/fig.32A: ground stud 1 inch copper



PTB/Fig. 32: #4 ground wires

THIS IS CONNECTING POINT  
TO GREAT UNDERGROUND  
NETWORK



INPUT END

CONDENSER RACK

PTB/ Fig. 33A: pipe frame bases



MAIN ANCHOR MODIFIED

PTB/ Fig. 35: Slot cut out

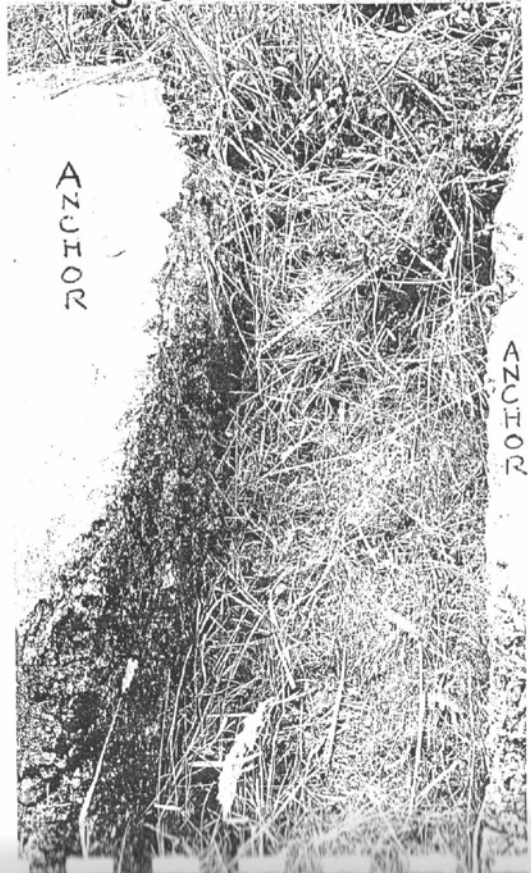



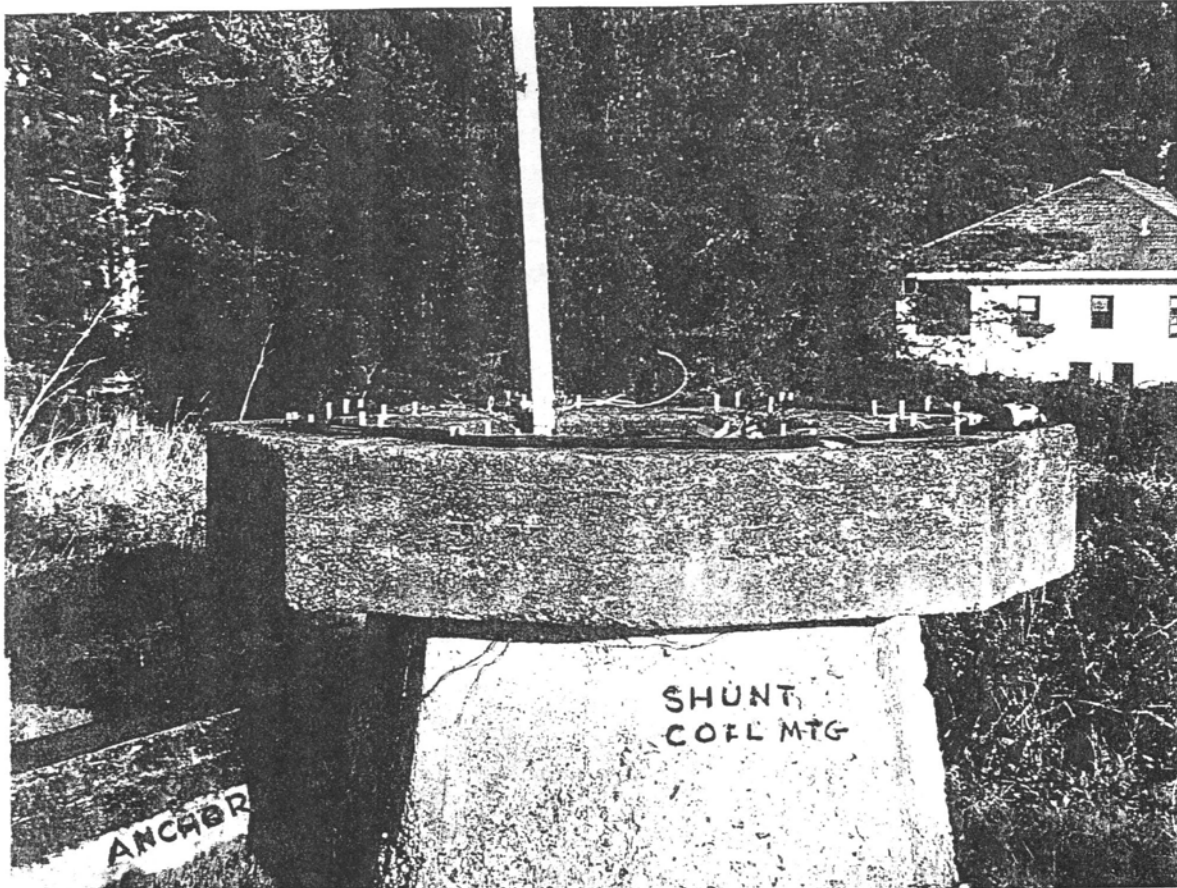

INPUT SECTION

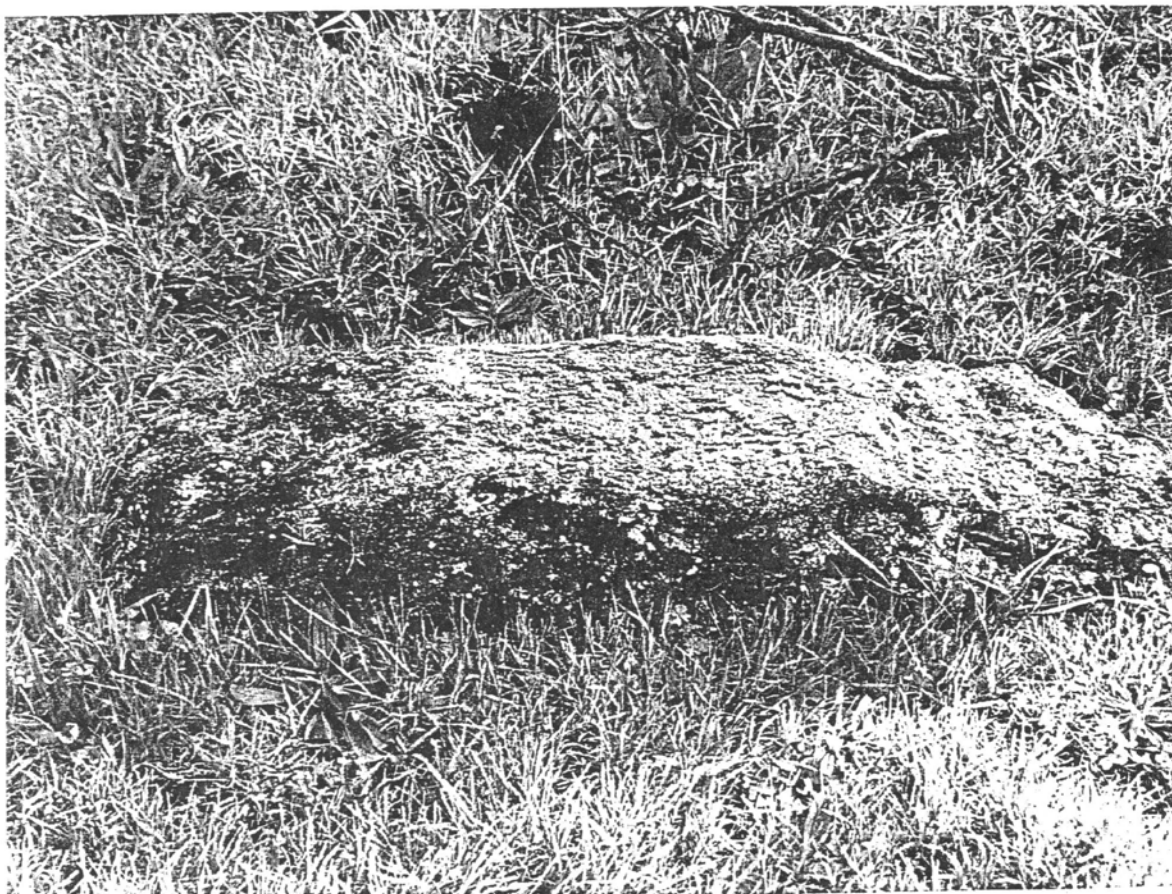

DIBE BASE INPUT. 1914



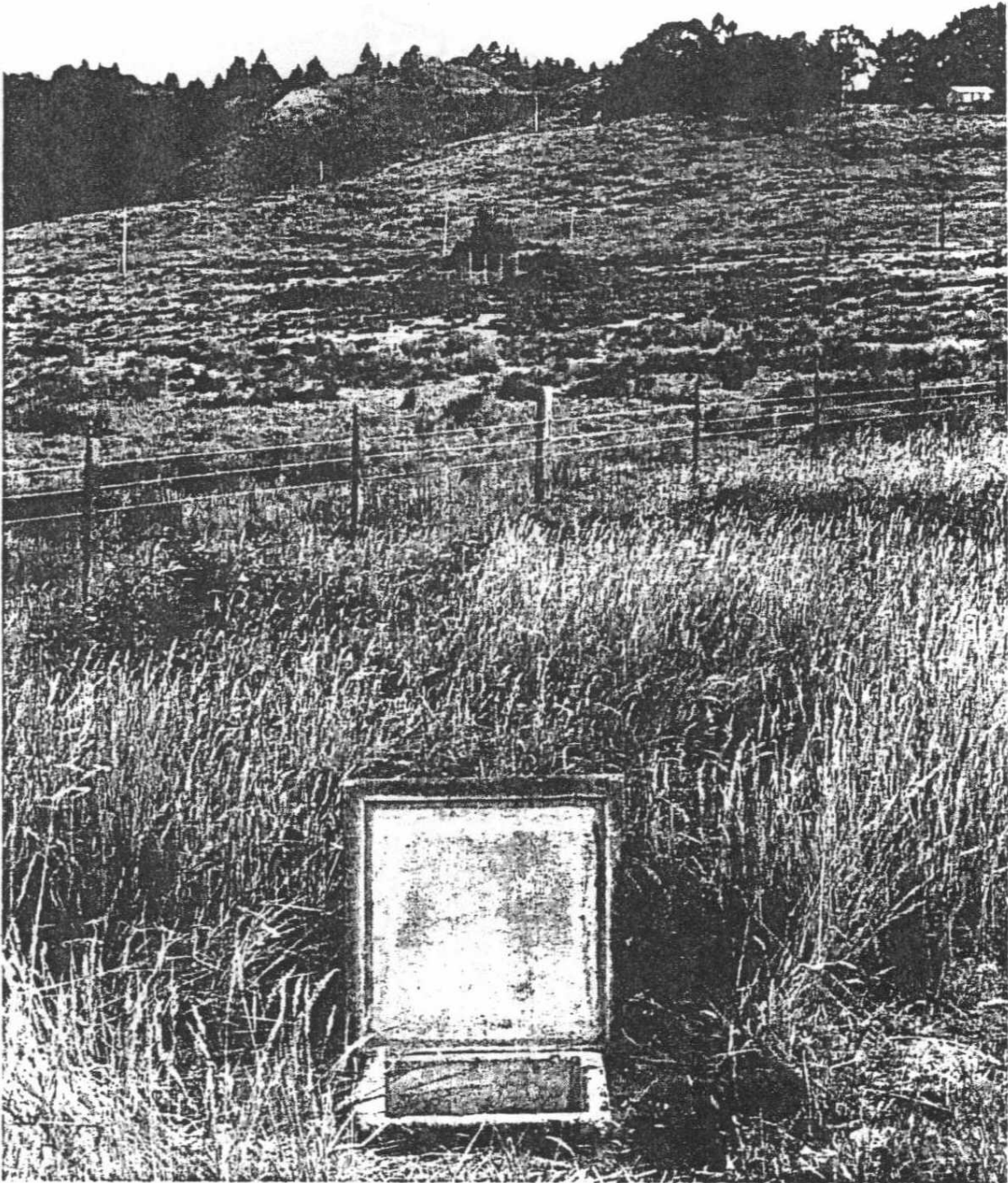

12 KV  
MANHOLE



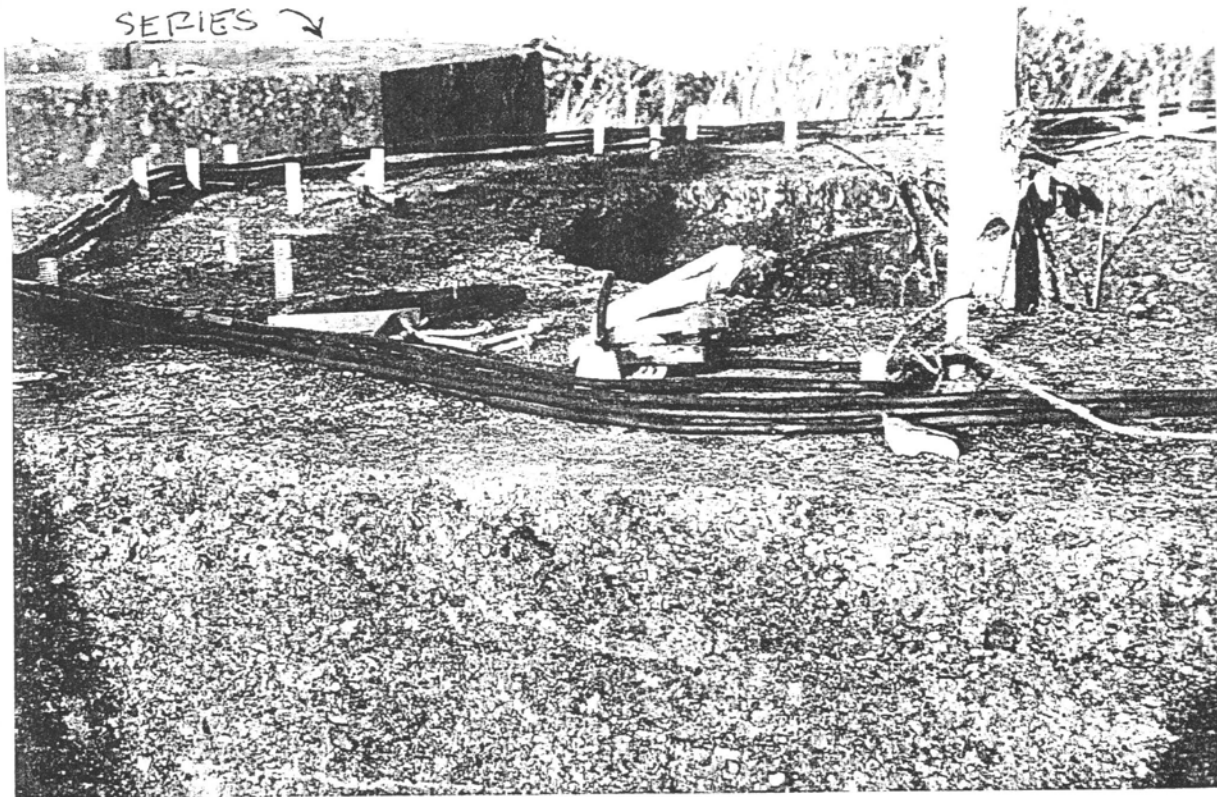

INPUT SECTION, SERIES MTG IN BACK

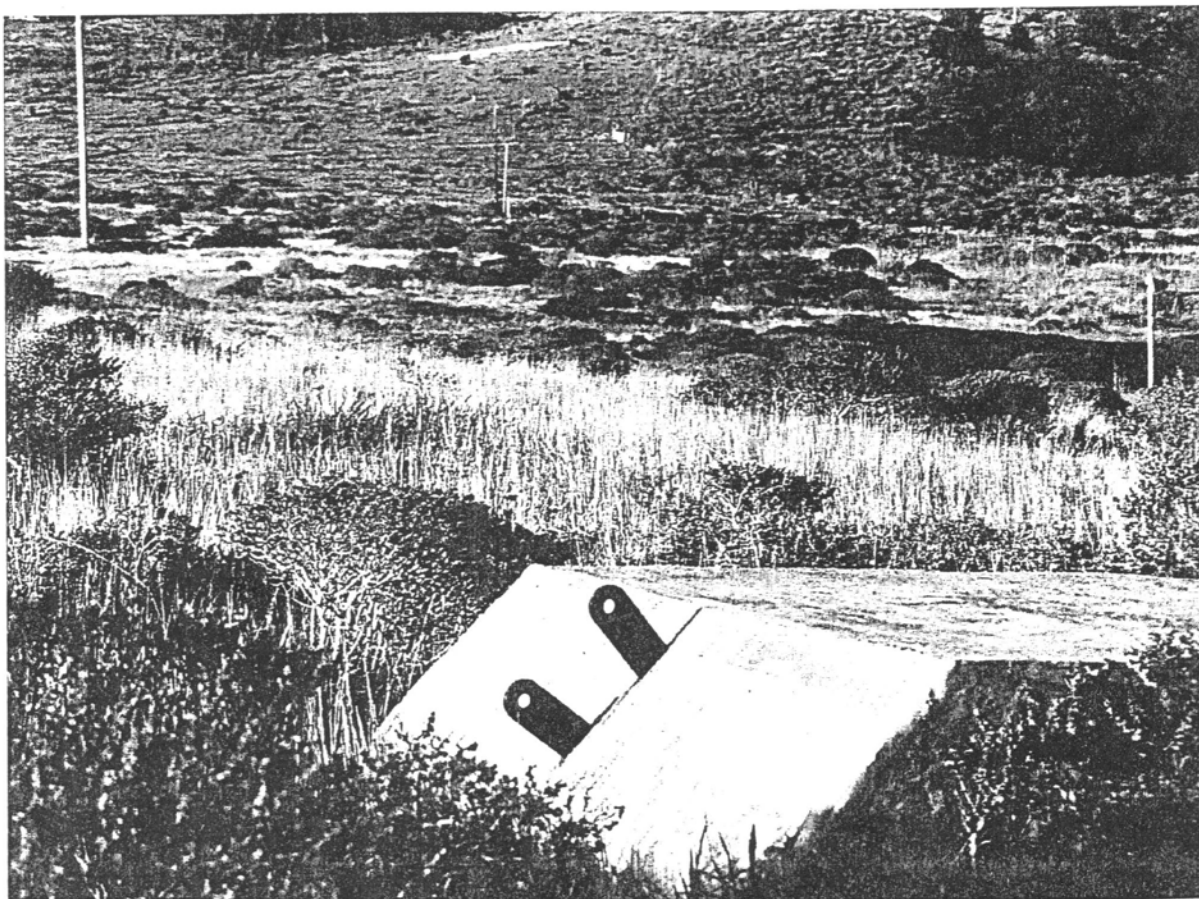
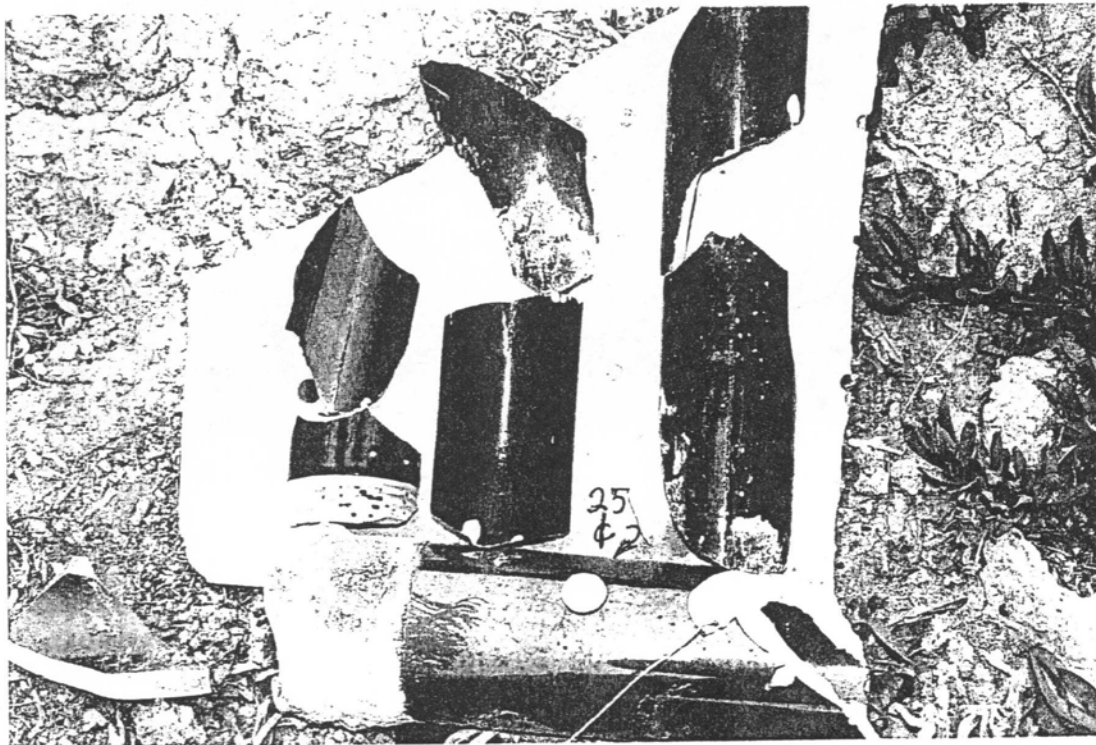

FIG 34 NAVY ANCHOR 1940



passersby take a little at a time. Some important items were under the protective custody of M.C.I. Corporation in building 2A. All may be lost by now.

*ALEXANDERSON BREAKAGE*



*BREAKAGE SITE*

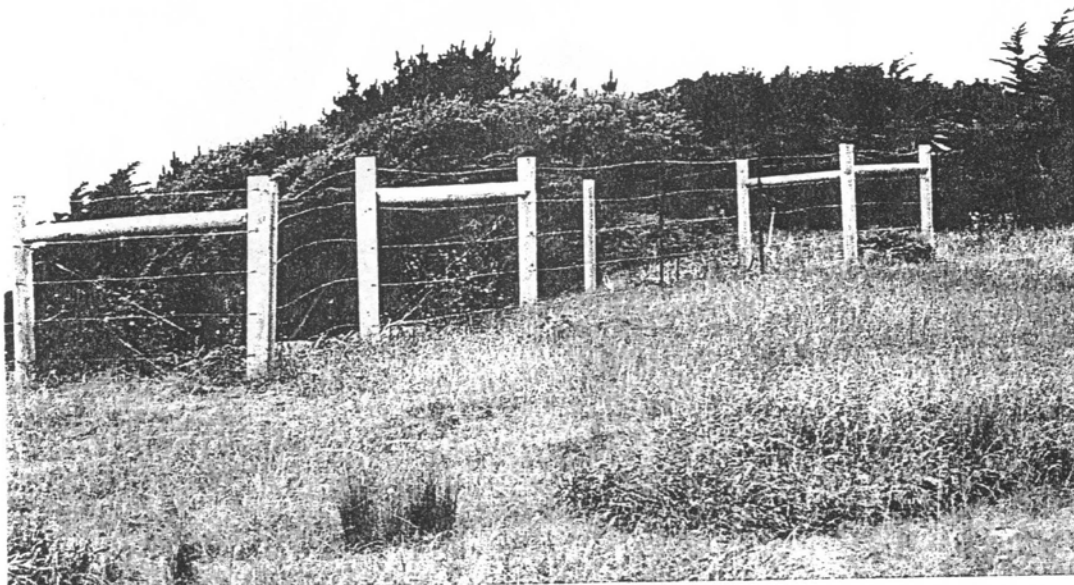

CENTRAL  
DUMP



MARCONI  
DUMP





MARCONI  
COIL  
BREAKAGE  
(G.S.W.A.)



BREAKAGE  
SITE

# *PART THREE*

## Alexanderson Aerial Electric Dimensions

Section 1)	Aerial Electric Constants . . . .	Page 291
Section 2)	Supporting Illustrations . . . .	Page 295
Section 3)	Experimental Scale Model . . . .	Page 306

## **Preface**

In the study of the history of the Bolinas electrostatic wireless, the Alexanderson system is of important interest to the theoretical electrical engineer. Since the Alexanderson principle still may play an important role in radio antenna development, a detailed analysis is given for the electrical operating characteristics and the physical layout of the Alexanderson aerial-ground structure and associated compensator networks. While lacking in exactness with regard to the actual Bolinas aerial, it functions in the same manner, and can be considered a "re-invention" of the system. Analog and scale models are developed for analytical study and historic representation.



## Alexanderson Aerial Electric Constants

l)

A) The electrostatic capacity of the Bolinas array can be divided into two distinct categories:

1) That part of the electrostatic field confined between the elevated capacity and the ground plane:

$$C_c = 1.5 \times 10^{-8} \quad \text{farad} \quad 0.015 \text{ uFd}$$

2) That part of the electrostatic field which extends from the elevated capacity to space:

$$C_s = 3.5 \times 10^{-9} \quad \text{farad} \quad 3500 \text{ pFd.}$$

And therefore a total electrostatic capacity of:

$$C_o = 1.9 \times 10^{-8} \quad \text{farad}$$

With a ratio of:

$$C_s : C_c = 0.35.$$

And a transmission efficiency of:

$$C_s : C_o = 19 \text{ percent.}$$

B) The electrostatic potential is given as:

$$E_o = 100 \quad \text{kilovolts.}$$

With an angular velocity of:

$$1.2 \times 10^5 \quad \text{radians per second.}$$

Energy is supplied to this potential at a rate of:

$$P = 200 \quad \text{kilowatts.}$$

C) For a peak potential of 100 kilovolts, the two electrostatic fields are:

1) The confined field:

$$\Psi = 1.8 \times 10^{10} \quad \text{lines of force}$$

$$W = 32 \quad \text{watt-second}$$

2) And the transmitted field:

$$\Psi = 4.2 \times 10^9 \quad \text{lines of force}$$

$$W = 7 \quad \text{watt-second}$$

D) For potential variation of  $1.2 \times 10^5$  radians per second, the power flow of the two electrostatic fields are:

1) Confined power flow:

$$P_c = 17 \times 10^6 \quad \text{volt-amperes}$$

$$X_c = 6 \times 10^2 \quad \text{sec. per farad (ohm)}$$

2) And the transmitted power flow:

$$P_s = 4.8 \times 10^6 \quad \text{volt-amperes}$$

$$X_s = 2 \times 10^3 \quad \text{sec. per farad (ohm)}$$

E) The total electric current transmitted into the earth is hence given:

$$I_o = 48 \quad \text{amperes}$$

With a transmission loss of 200 kilowatts and a corresponding electromotive force of:

$$E_o = 4200 \quad \text{volts}$$

F) For the entire array the total power flow is:



$$P = 21 \times 10^6 \quad \text{volt-amperes}$$

And for a dissipation rate of 200 kilowatts, the power multiplication factor is thus given:

$$\varphi = 100 \times \quad \text{dimensionless}$$

II) The entire array is divided into three distinct section elements: element 1 and element 2, and a third terminal element

A) The mid-section elements are of the following electrical dimensions:

1) Electrostatic capacity to space:

$$\begin{array}{lll} C_s = 1.4 \times 10^{-9} & \text{farad} & 1400 \text{ pFd} \\ P_s = 1.7 \times 10^4 & \text{volt-amperes} & \\ I_s = 17 & \text{amperes} & \\ X_s = 6 \times 10^3 & \text{sec. per farad} & 6K_{\Omega} \end{array}$$

2) Electrostatic capacity to ground:

$$\begin{array}{lll} C_c = 4.9 \times 10^{-9} & \text{farad} & 4900 \text{ pFd} \\ P_c = 5.6 \times 10^6 & \text{volt-amperes} & \\ I_c = 56 & \text{amperes} & \\ X_c = 1.8 \times 10^3 & \text{sec. per farad} & 1.8K_{\Omega} \end{array}$$

3) Electromagnetic inductance:

$$\begin{array}{ll} L = 1.3 \times 10^{-4} & \text{Henry} \\ X_L = 16 & \text{Henry/sec. (OHM)} \end{array}$$

4) The electro-motive force developed by the electromagnetic induction of the element half-section  $L/2$  is given by the relation:

$$E_L / I_T = X \quad E = 550 \quad \text{volts}$$

And therefore, the power flow of this induction:

$$E_L \times I_T = \quad P = 40 \times 10^3 \quad \text{volt-amperes}$$

And thus the ratio of magnetic to electrostatic power flow is:

$$P_L : P_O = 40:7300 = 1.5 \text{ percent}$$

B) Having derived the electromagnetic and the electrostatic coefficients of the elemental sections, the electromagnetic propagation coefficients are thus:

$Z_c$  = transmission impedance of confined electromagnetic wave

$$Z_c = 173 \text{ ohm}$$

$Z_s$  = transmission impedance of un-confined electromagnetic wave

$$Z_s = 316 \text{ ohm}$$

And likewise:

$V_o$  = transmission velocity of confined propagation

$$V_o = 3 \times 10^{10} \text{ cm./sec.}$$

$V_s$  = transmission velocity of un-confined propagation

$$V_s = 5.6 \times 10^{10} \text{ cm./sec.}$$



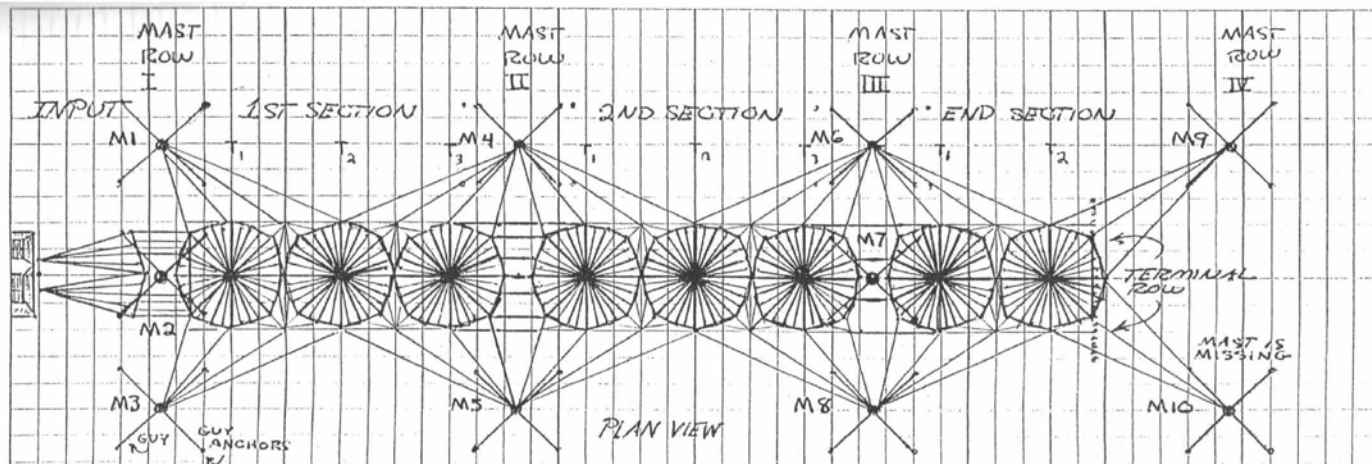

BLUE, BRONZE  
BLACK, IRON

US NAVY 19 KILO CYCLE ANTENNA  
ALEXANDERSON ARRAY (RCA) BOLINAS (1919)

FIG 1A

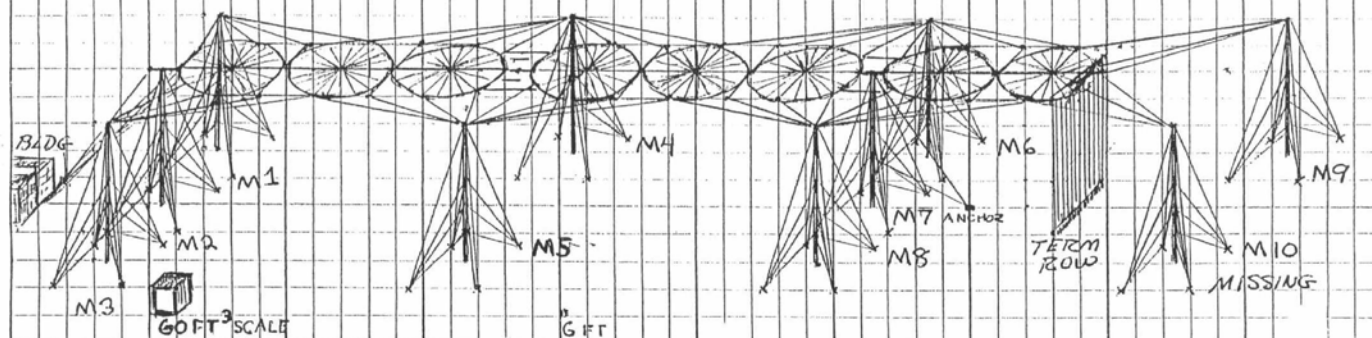

- ALEXANDERSON -  
ELEMENTARY DIAGRAM

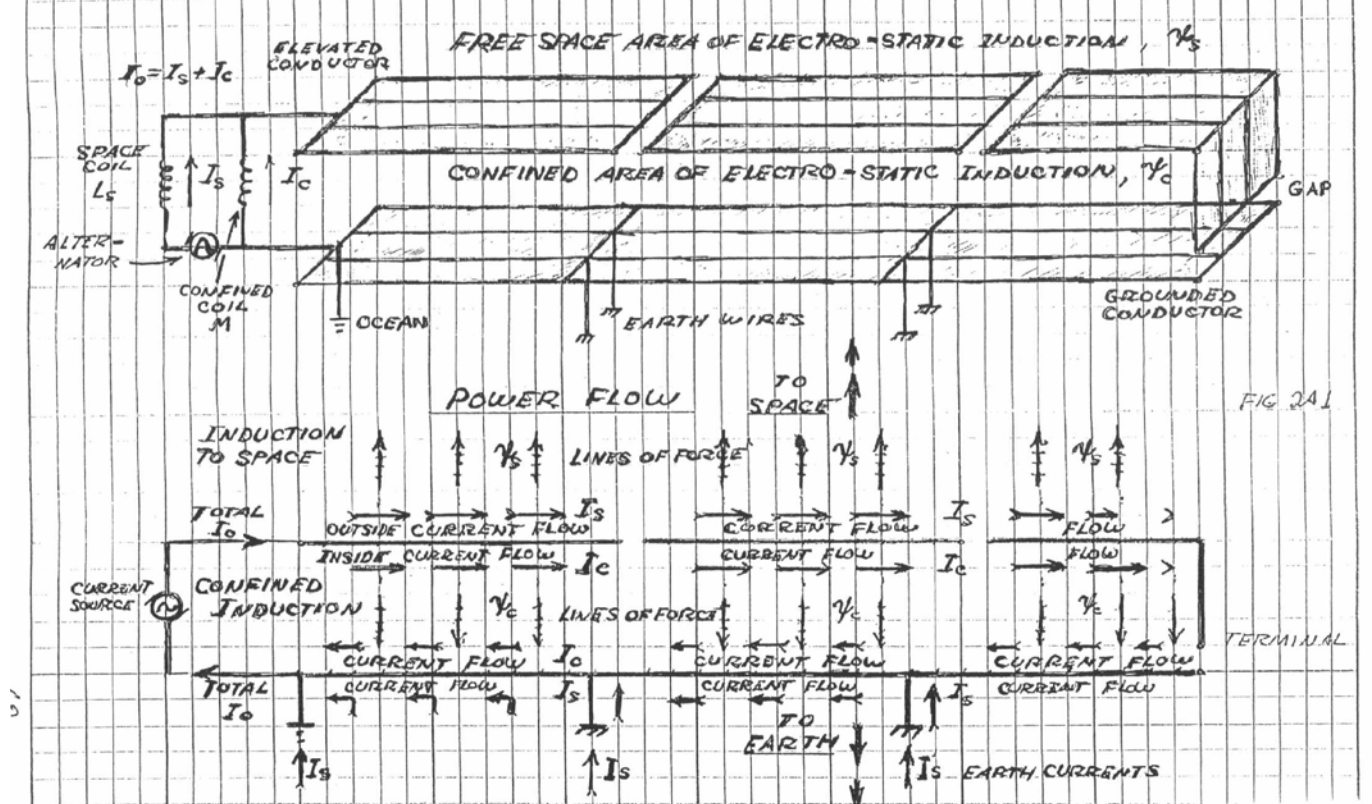

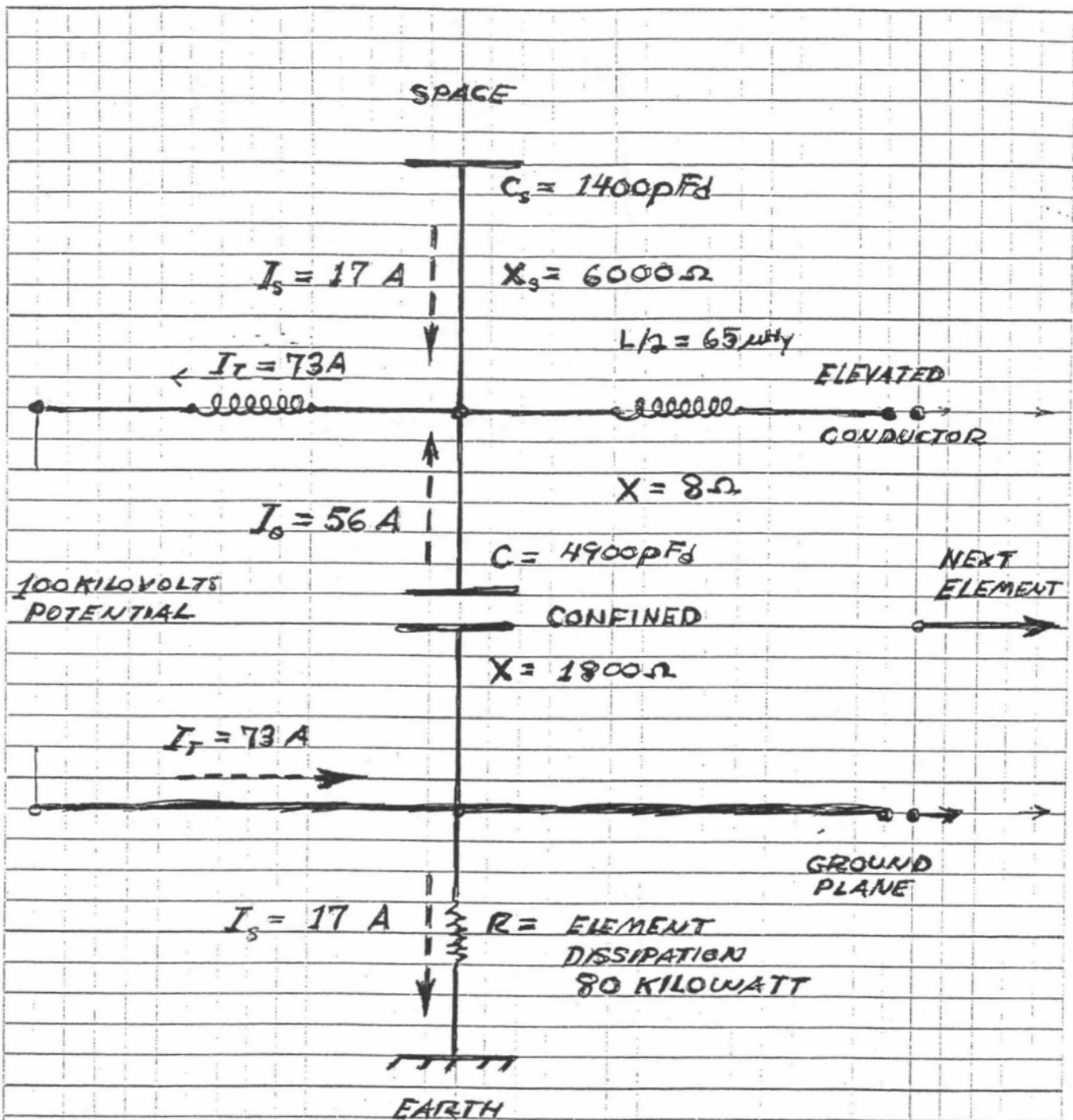

EQUIVALENT CIRCUIT  
OF ELEMENTAL  
SECTION OF BOLINAS  
ALEXANDERSON ARRAY



COMPLETE ANALOG CIRCUIT OF ALEXANDERSON NETWORK (ANY SCALE)

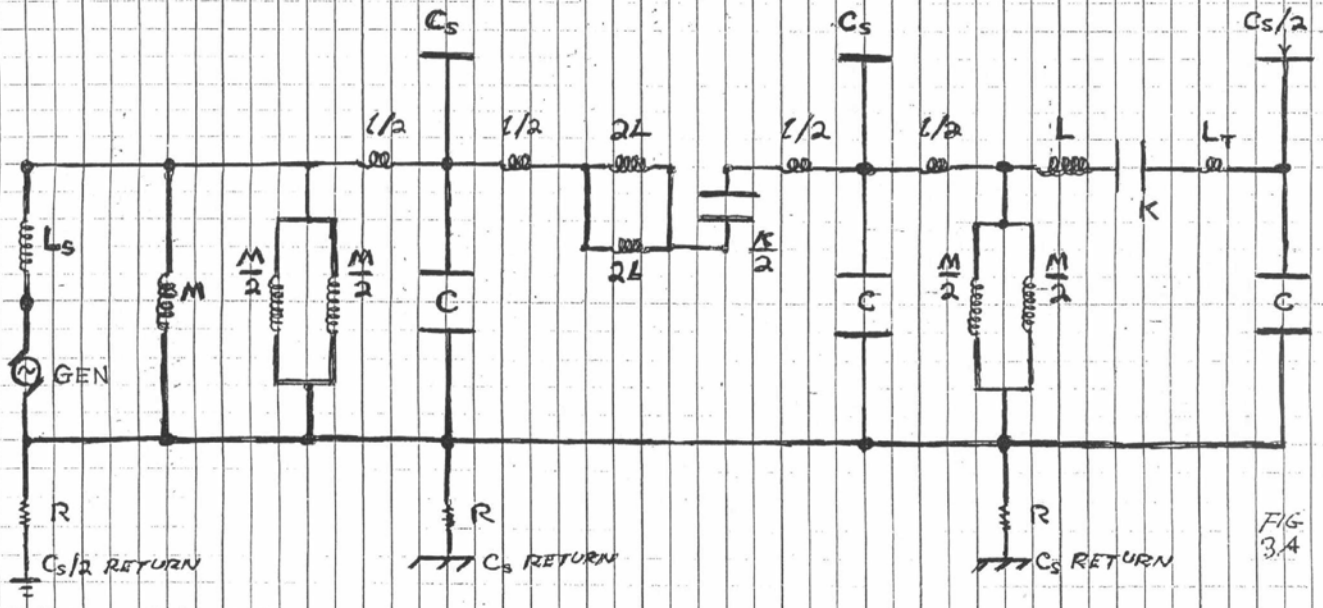
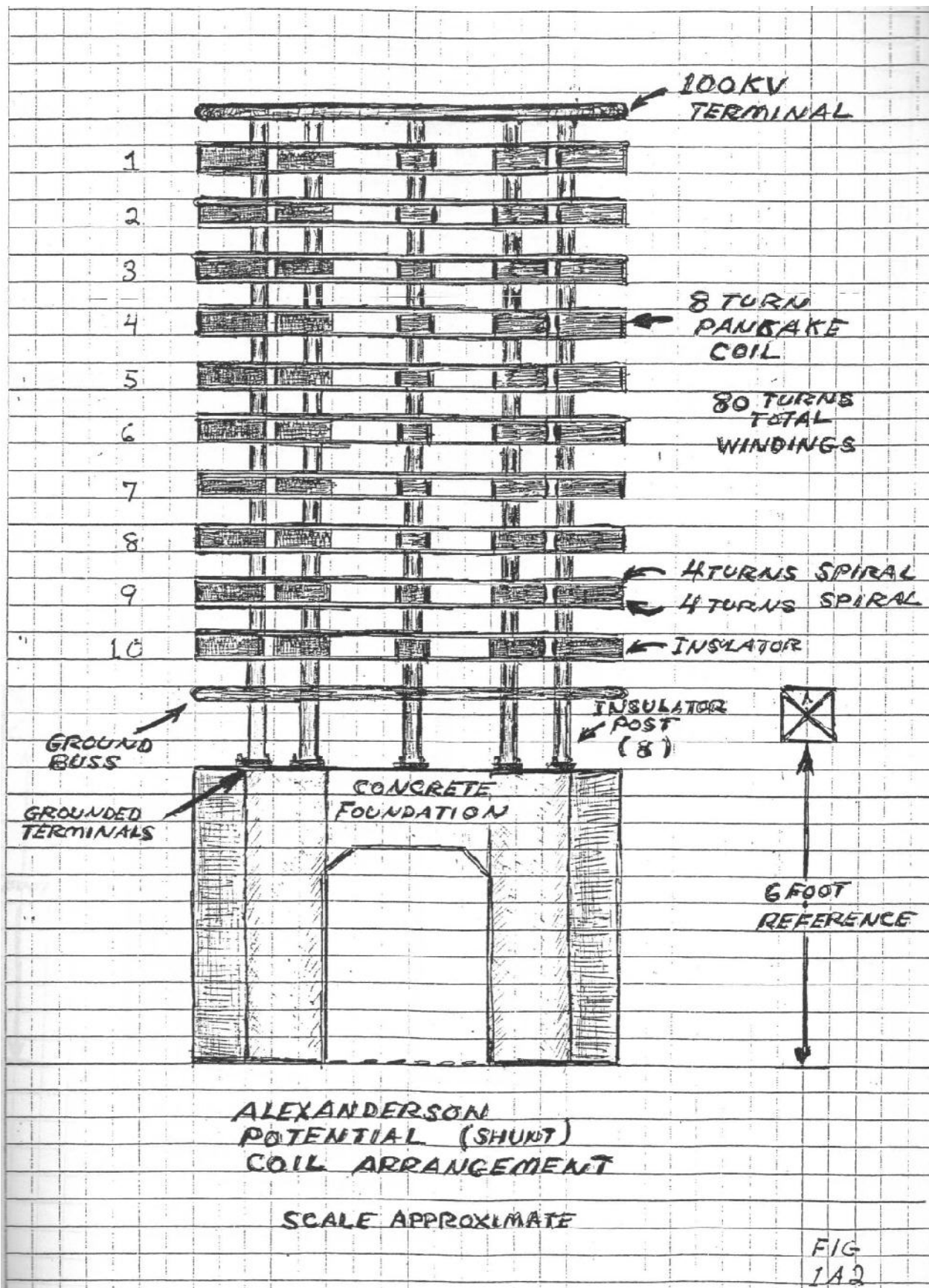
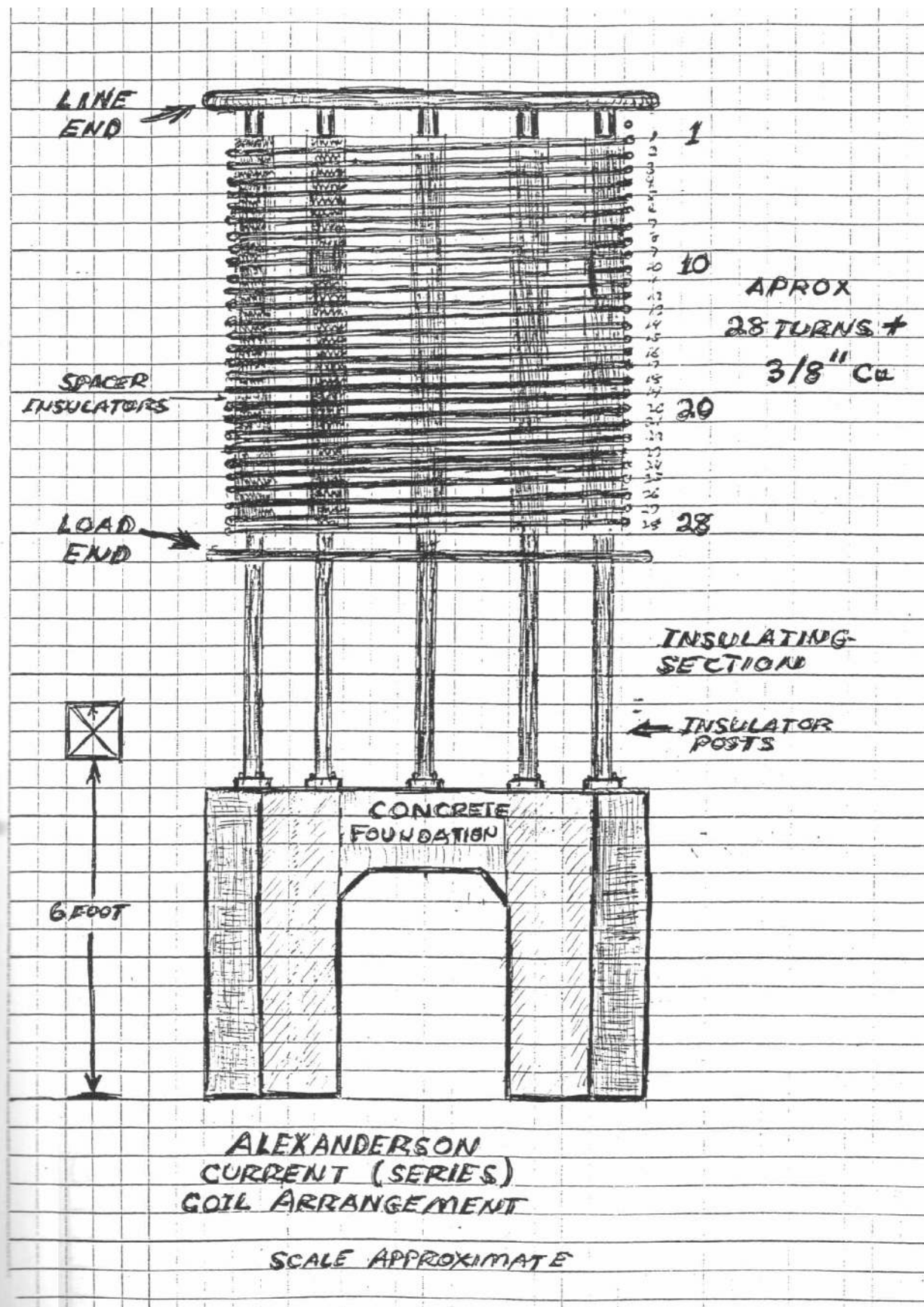

FIG 3.4

BLDG	FIRST ROW	SEC. ROW	THIRD ROW	END
$M = 1800\ \Omega$	$l = 16\ \Omega$	$C_s = 6000\ \Omega$	$G = 114\ \Omega$ LOAD, ALTERNATER	
$L = 480\ \Omega$	$C = 1800\ \Omega$	$C_s/2 = 12\ K\ \Omega$	$\omega = 2\ \pi\ F$	
$L_s = 2400\ \Omega$	$K = 480\ \Omega$	$R = 210\ \Omega$	$F =$ ANY SCALE FREQUENCY	







ARCH TYPICAL WIRELESS SYSTEMS

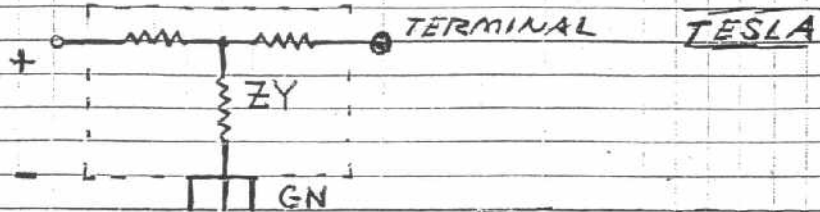
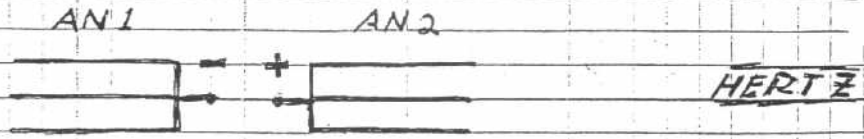

GN, GROUND WIRES  
AN, ANTENNA WIRES  
ZY, TRANSFORMER  
+-, INPUT

DERIVATIVE SYSTEMS

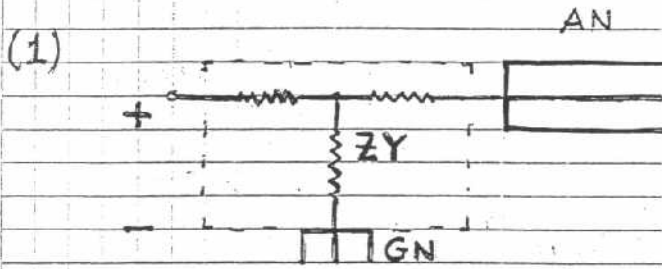

MARCONI

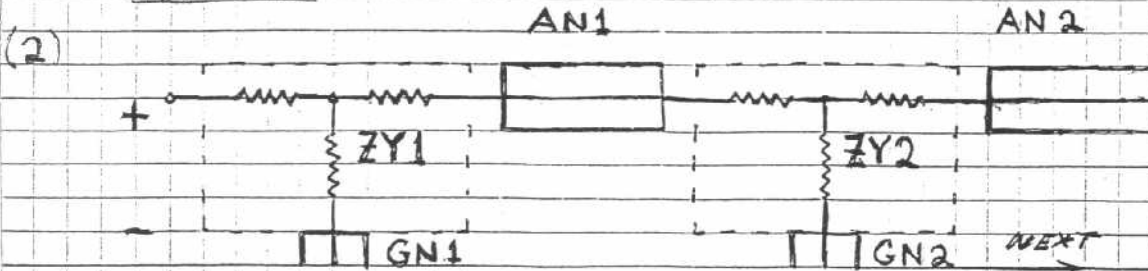

ALEXANDERSON

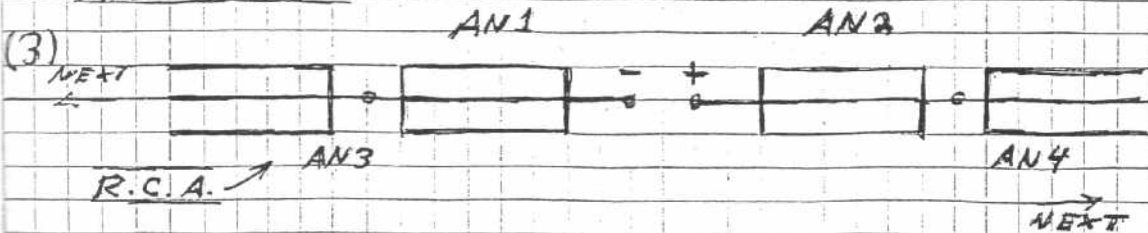

R.C.A.



# ELECTRO-MAGNETIC RADIO ANTENNAE

← ONE HALF WAVELENGTH →

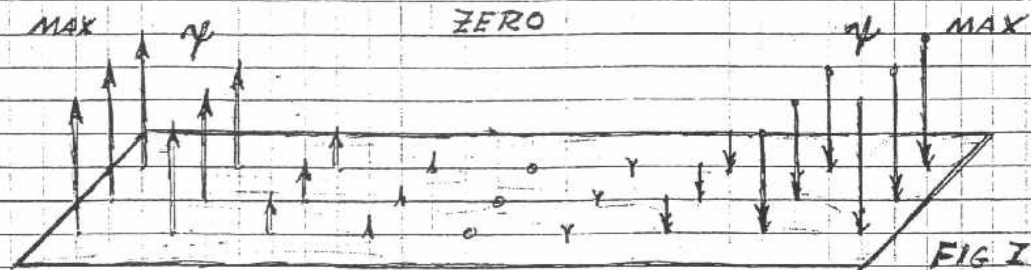

ELECTRO-STATIC  
(DIELECTRIC)  
INDUCTION

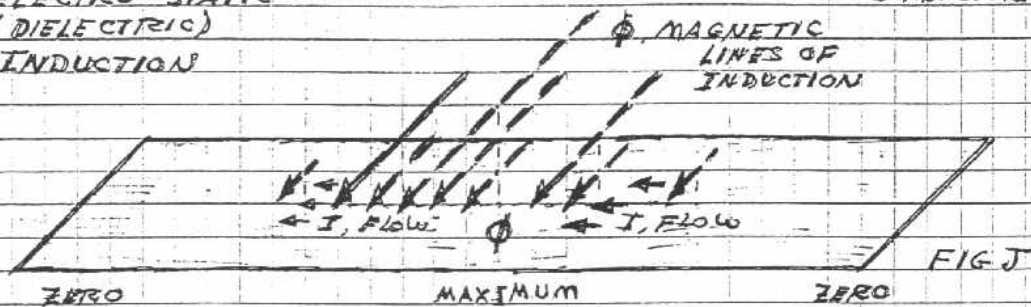

MAGNETIC  
INDUCTION

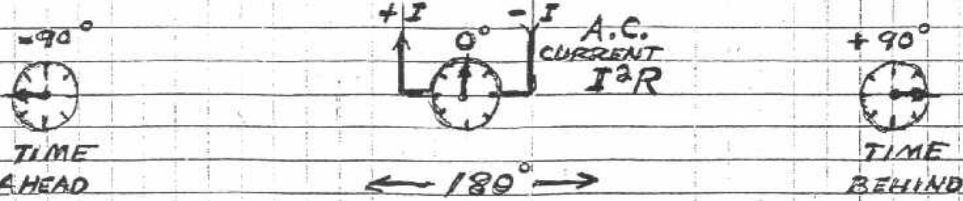
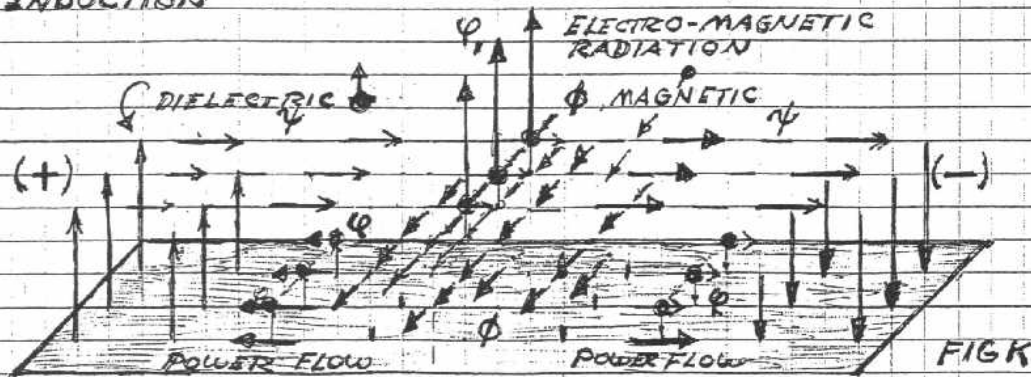

ELECTRO-MAGNETIC RESULTANT  
RADIATION & POWER FLOW

ψ DIELECTRIC  
Φ MAGNETIC  
Ψ ELECTRO-  
MAGNETIC

# ELECTRO-STATIC ANTENNAE (NO WAVELENGTH)

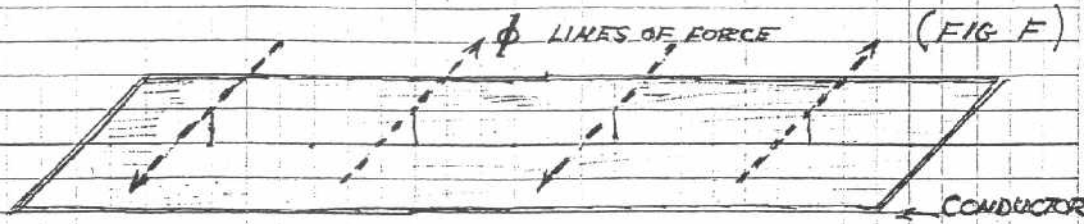

$\phi$   
MAGNETIC

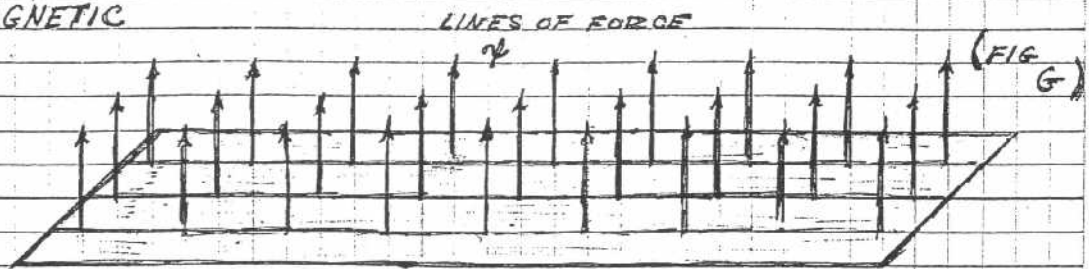

$\psi$   
DIELECTRIC

## ELECTRO-STATIC TRANSMISSION

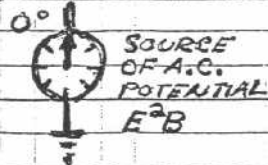
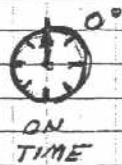
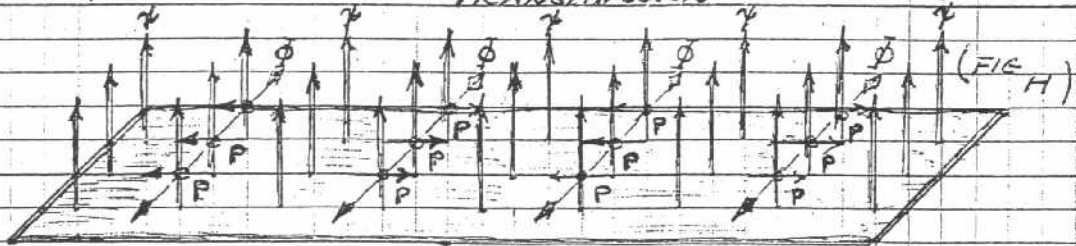

COMPOSITE  
ELECTRIC FIELD  
& POWER FLOW



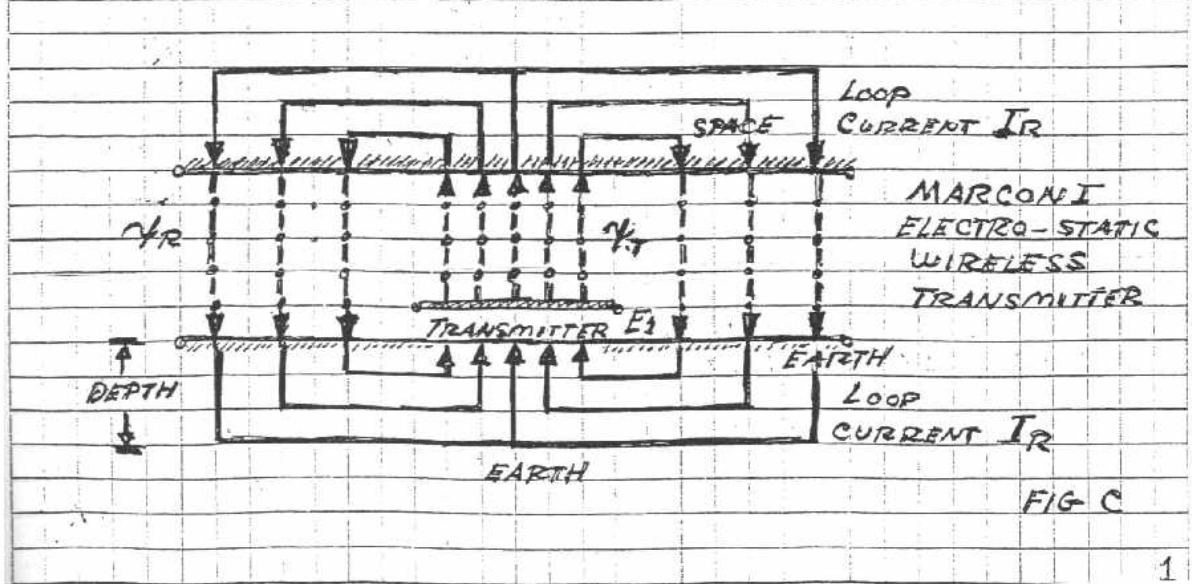
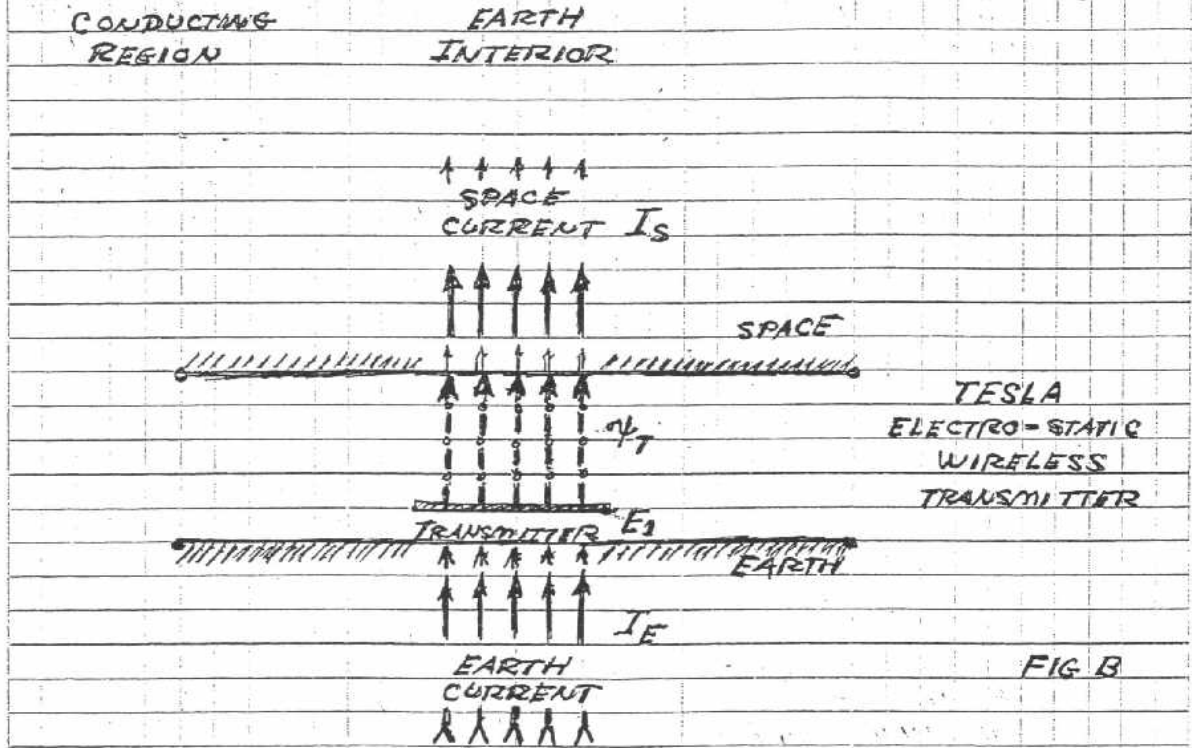
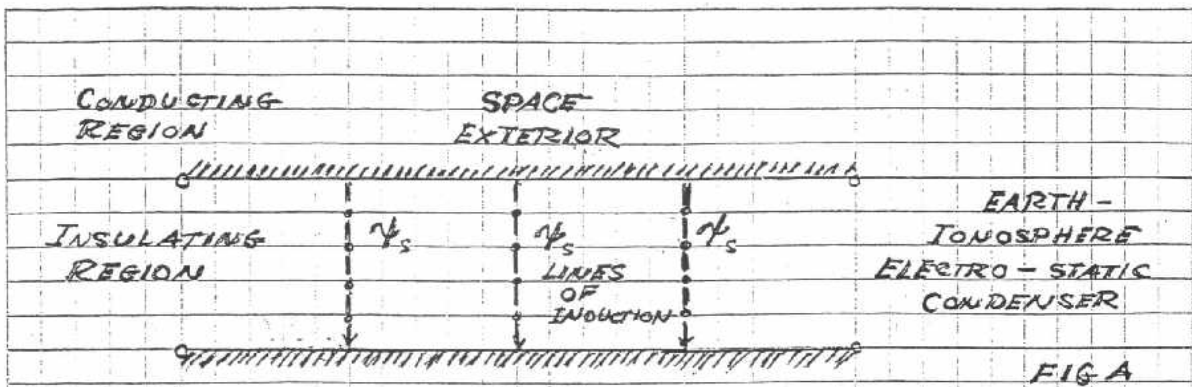

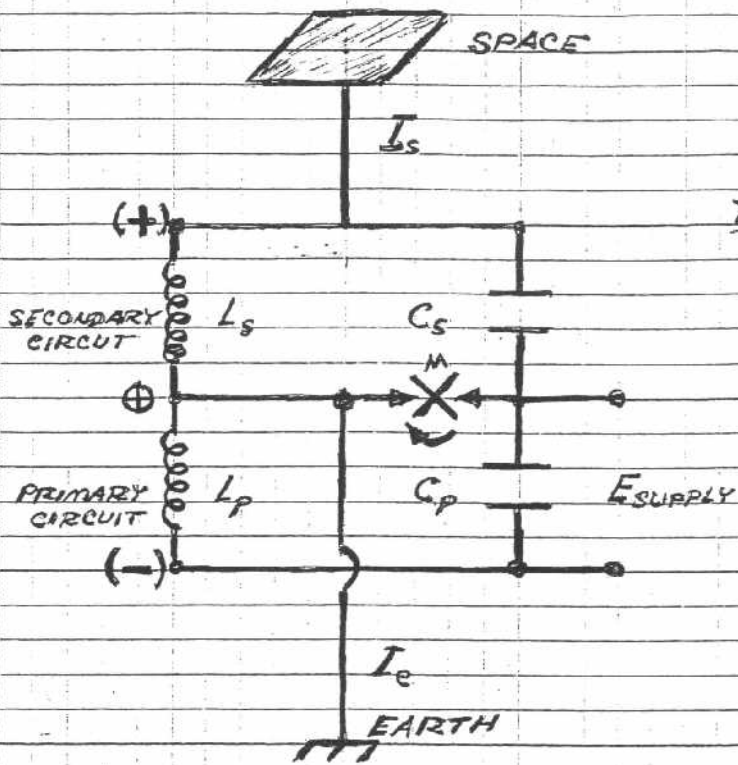

FIG D

TESLA SYSTEM

SPACE CURRENT  
LEADS GROUND  
CURRENT BY 90°

$$a I_e = -j I_s$$

$$a = |I_s \circ I_e|$$

$$a \neq 1$$

FIG E

MARCONI SYSTEM

SPACE CURRENT  
EQUAL TO  
GROUND CURRENT

$$I_e = -I_s$$

$$a = 1$$

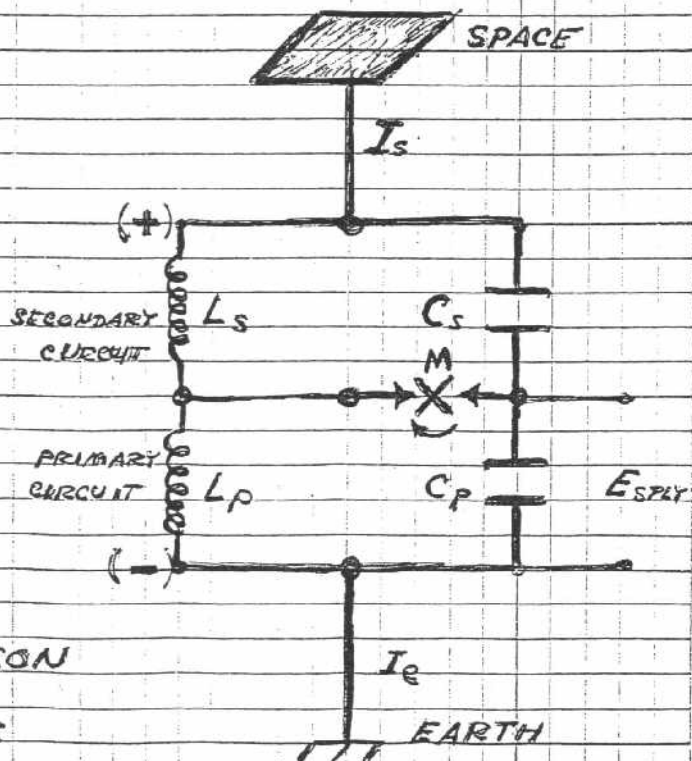

SYMBOLIC COMPARASON  
OF ELECTRO-STATIC  
WIRELESS SYSTEMS

TESLA VS MARCONI

- L, COIL
- C, CONDENSER
- M, CHOPPER (BREAK)



**SCHEMATIC REPRESENTATION OF BOLINAS NETWORK**

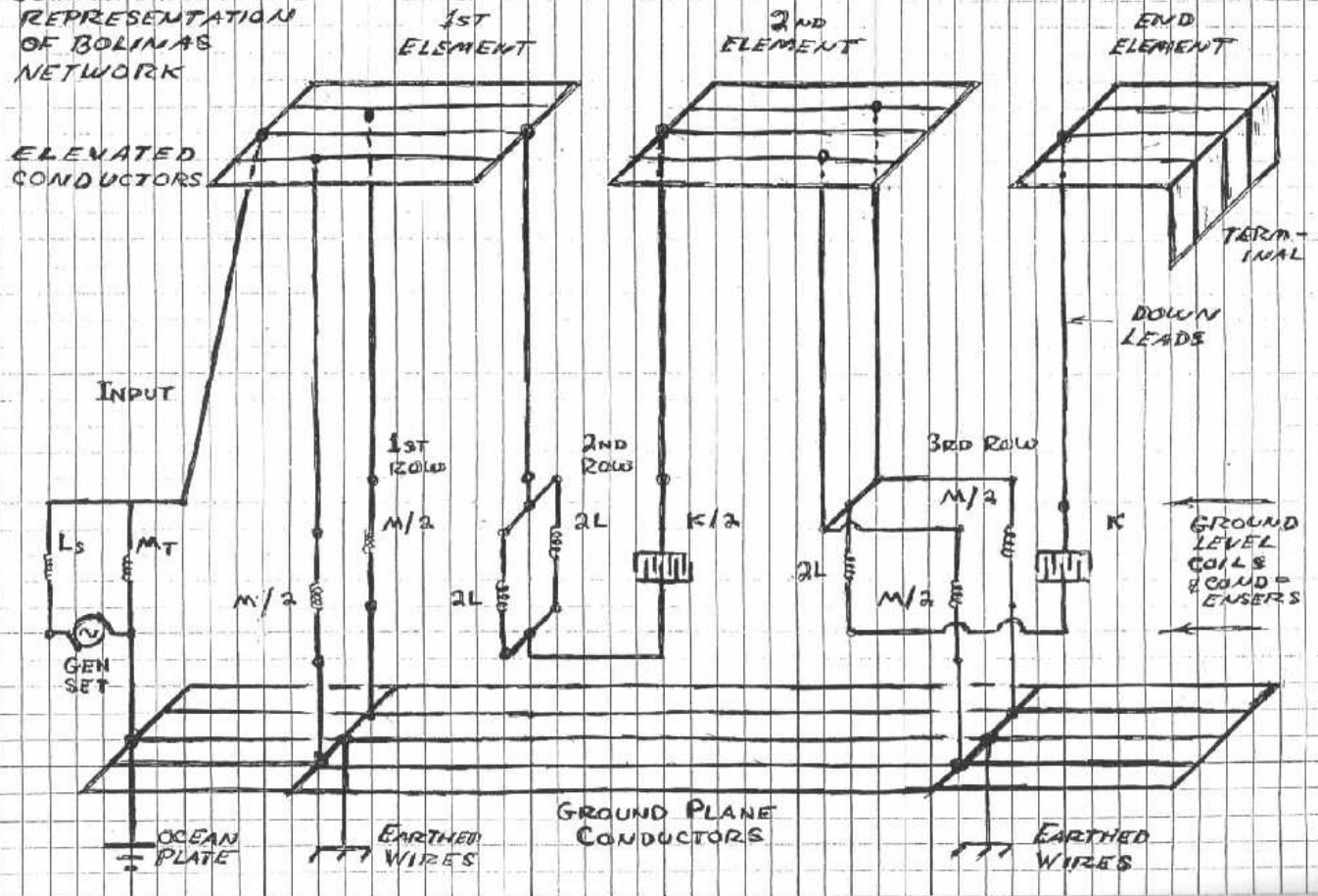

XIII

FIRST EXPERIMENTAL SCALE MODEL OF ALEXANDERSON ANTENNA NETWORK

a) SCALE  $\alpha = 0.01$ , POWER  
 $\alpha^{1/2} = 0.10$ , E.M.F. & CURRENT

LENGTH 2700 FT  $\alpha = 27$  FT

EACH ELEMENT 720 FT  $\alpha = 7.2$  FT  $l_1 = 86$  INCH

WIDTH 240 FT  $\alpha = 2.4$  FT  $w = 28$  INCH

HEIGHT 300 FT  $\alpha = 3.0$  FT  $h = 36$  INCH

FREQ 19 Kc/SEC  $\alpha = 1900$  Kc

COIL HEIGHT 8 FT  $\alpha^{1/2} = 10$  INCH  $l_c = 10$  INCH

COIL DIAM. 6 FT  $\alpha^{1/2} = 7$  INCH  $d = 7$  INCH

$M = 15$  mHy,  $1800 \Omega = 150 \mu$ Hy,  $1800 \Omega$

$\frac{1}{2}M = 30$  mHy,  $3600 \Omega = 300 \mu$ Hy,  $3600 \Omega$

$L_s = 20$  mHy,  $2400 \Omega = 200 \mu$ Hy,  $2400 \Omega$

$L = 4$  mHy,  $480 \Omega = 40 \mu$ Hy,  $480 \Omega$

$K = 0.018 \mu$ Fd,  $480 \Omega = 180$  pFd,  $480 \Omega$

$\omega = 1.2 \times 10^5$  RAD/SEC  $1.2 \times 10^7$  RAD/SEC



1900 Kc/SEC (1:100 SCALE MODEL)  $Q = 0.01$  RATIO  
 MODEL NETWORK, COIL SCALE  $\rightarrow NCL = 0.10$  RATIO  
 (12 FOOT POLES, 6 FOOT CROSS ARMS)

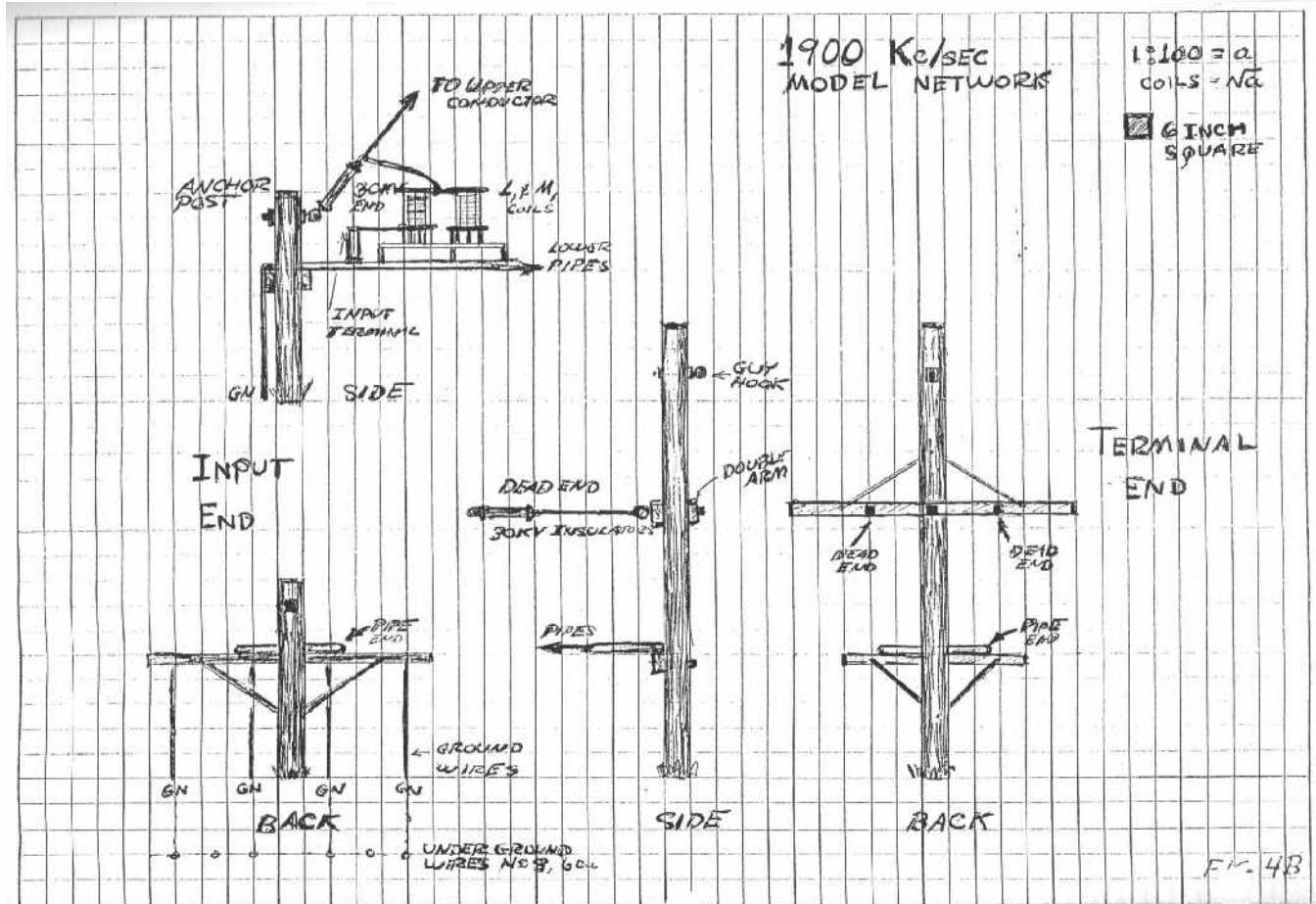
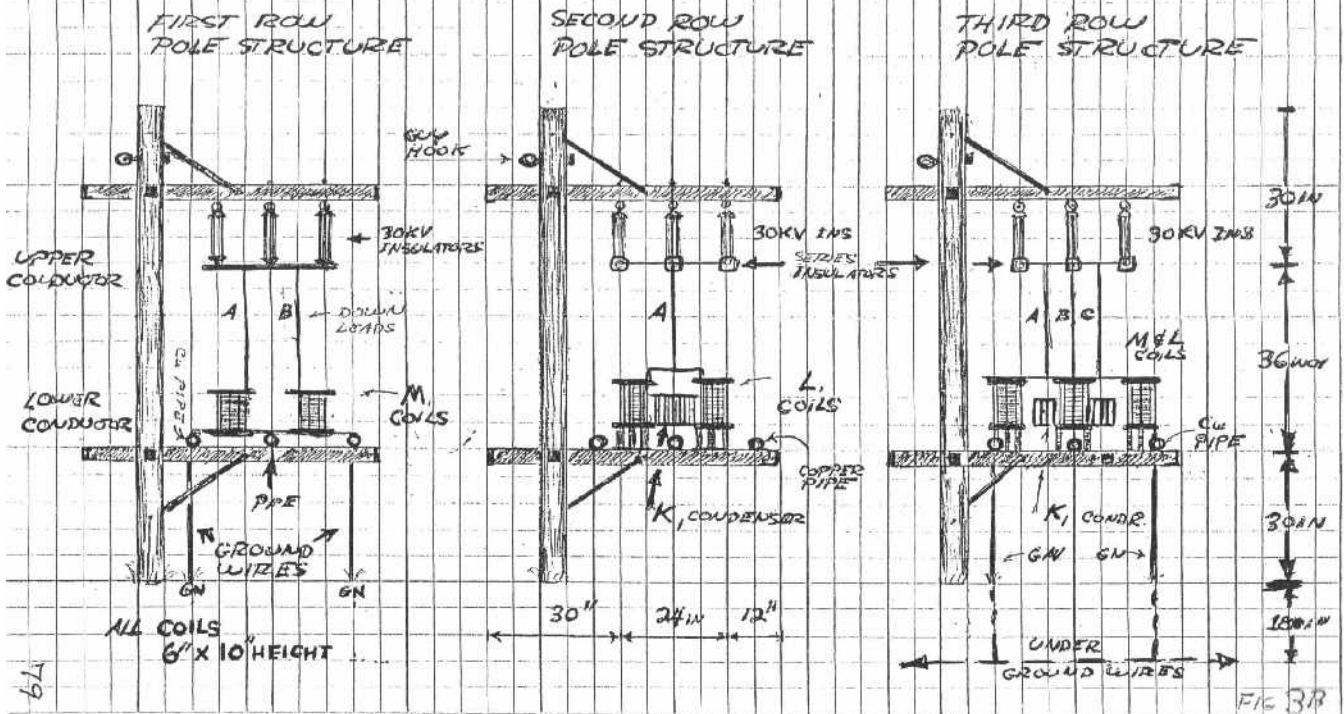



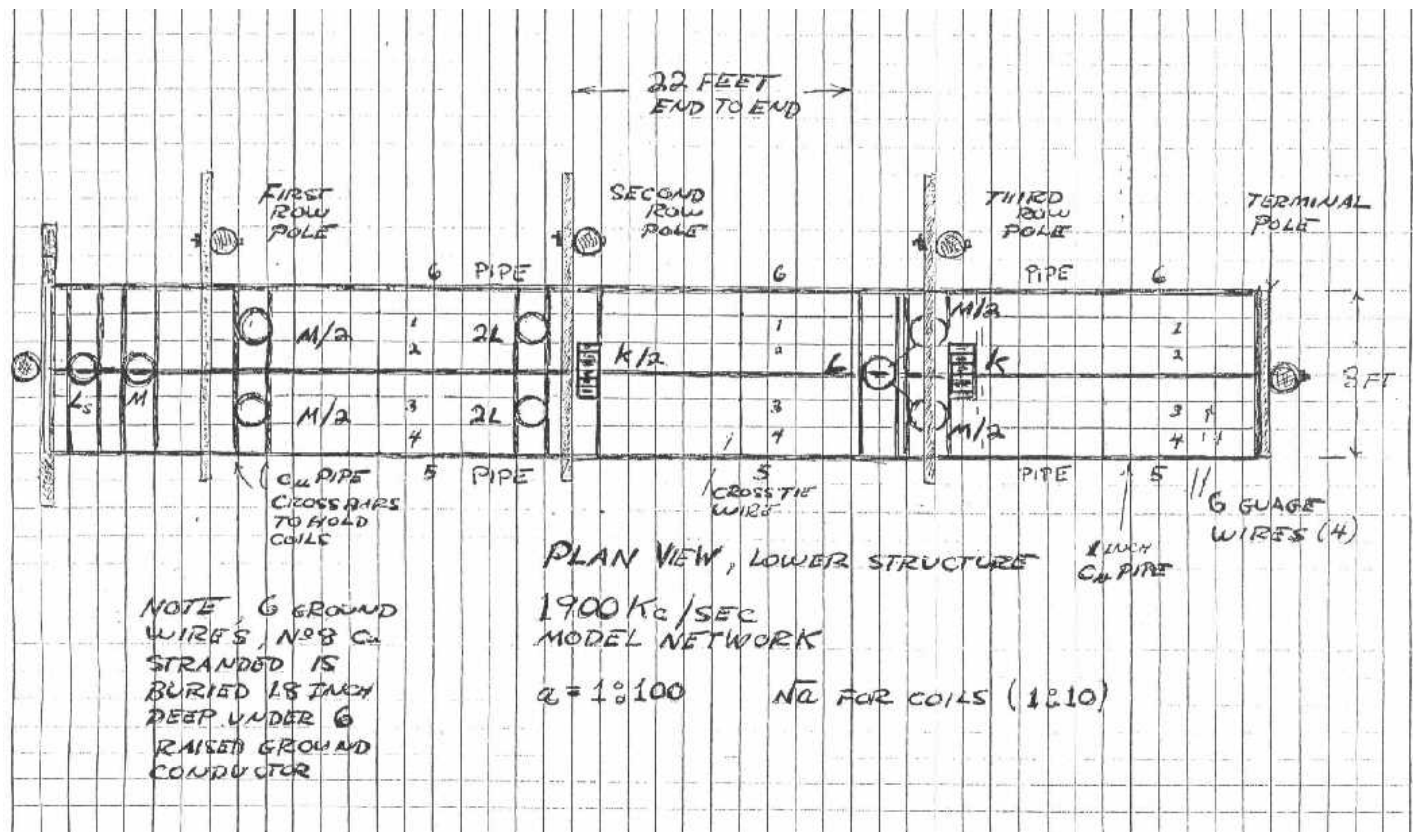
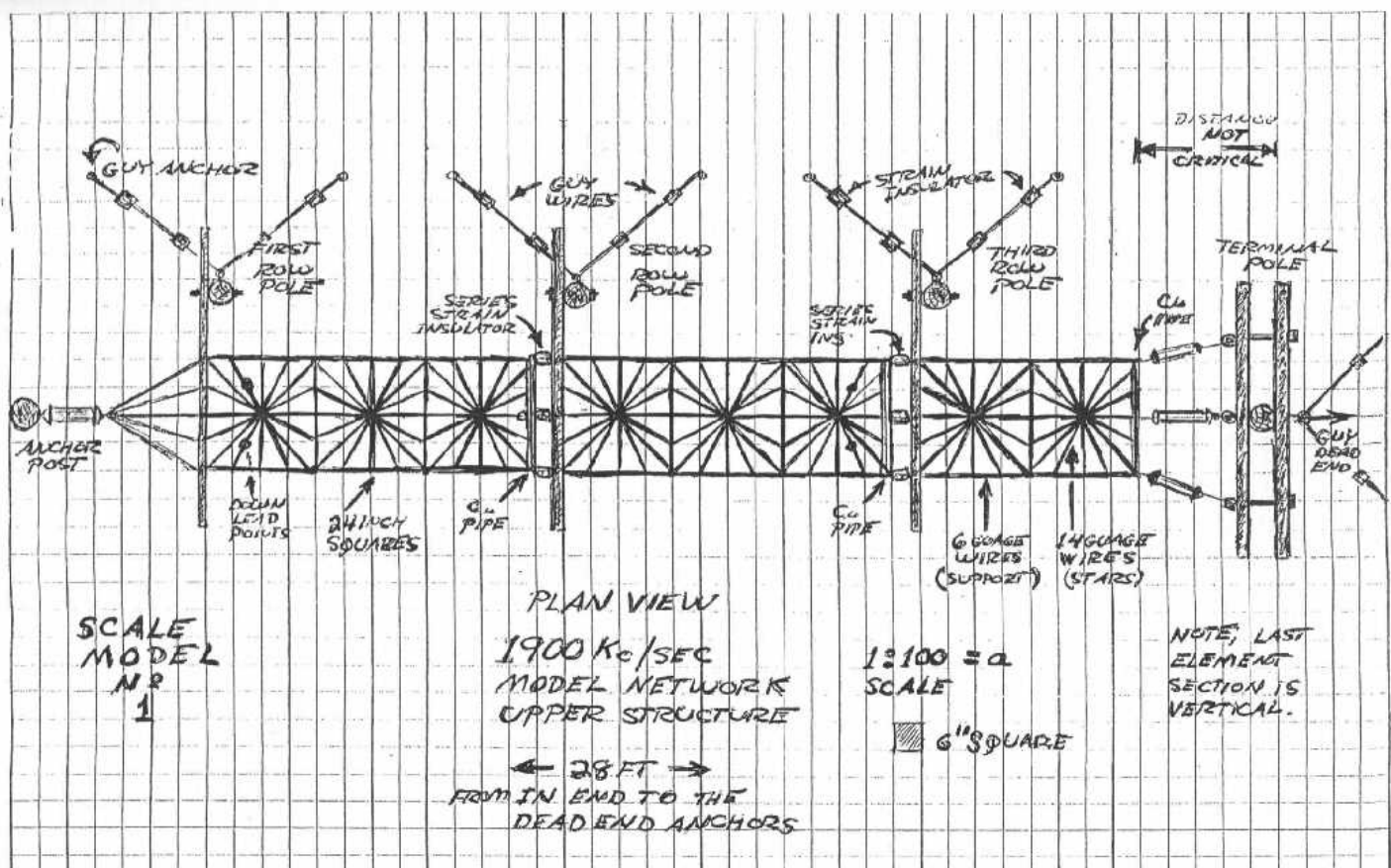



# *APPENDICES*

APPENDIX I	Experimental Networks . . .	Page 310
APPENDIX II	Complex Electric Theory . . .	Page 321
APPENDIX III	Historic Patents . . . . .	Page 340
	Tesla . . . . . US Patent #1,119,732 . . .	Page 341
	Marconi . . . . . US Patent #586,193 . . .	Page 346
	Alexanderson . . . . . US Patent #1,360,167 . . .	Page 358
	Heising . . . . . US Patent #1,562,961 . . .	Page 370

## APPENDIX I

### EXPERIMENTAL ANALOG COMPUTING NETWORKS FOR THE STUDY OF COMPLEX ELECTRIC WAVES<sup>o</sup>

#### 1) TRANSVERSE ELECTRO-MAGNETIC PROPAGATION ON SECTION OF T.E.M. TRANSMISSION LINE

FIG (1) LOW PASS FILTER TYPE CHARACTERISTICS, PHASE LAG CONDITION, CAUSE BEFORE EFFECT

FIG (3) HARMONIC RESONANT SERIES, ODD ORDER QUARTER WAVE MULTIPLES, FORWARD SLOPE

#### 2) LONGITUDINAL MAGNETO-DIELECTRIC PROPAGATION ON SECTION OF L.M.D. TRANSMISSION LINE

FIG (1) HIGH PASS FILTER TYPE CHARACTERISTICS, PHASE LEAD CONDITION, EFFECT BEFORE CAUSE

FIG (2) HARMONIC RESONANT SERIES, ODD ORDER QUARTER WAVE MULTIPLES, CONTRARY SLOPE

#### 3) COMPLEX PROPAGATION ON SECTION OF SHUNT CONCA TENATED TRANSMISSION LINE. OSCILLATION TRANSFORMER ANALOG (TESLA TRANSFORMER)

FIG (4) HIGH PASS FILTER TYPE CHARACTERISTICS, PHASE LEAD CONDITION, EFFECT BEFORE CAUSE

FIG (5) EN-HARMONIC RESONANT SERIES, ODD ORDER QUARTER WAVE MULTIPLES, SLOPING CONTRARY SLOPE

FIG (6) TRANSMISSION LINE RESPONSE TO DISRUPTIVE DISCHARGE, CONTINUOUSLY LAGGING PHASE LAG, OR DOWNWARD FREQUENCY SHIFT.



4) COMPLEX PROPAGATION ON SECTION OF SERIES  
CONCA TENATED TRANSMISSION LINE, ALEXANDERSON  
AERIAL ANALOG.

FIG (7) TRANSMISSION LINE RESPONSE TO DISRUPTIVE  
DISCHARGE, DISCONTINUOUSLY LAGGING PHASE  
LAG, OR DISCONTINUOUS DOWNWARD FREQUENCY  
SHIFT.

FIG (8) BAND-PASS FILTER TYPE CHARACTERISTIC,  
PHASE LAG-LEAD CONDITION, INTERCHANGE  
OF CAUSE AND EFFECT WITH EFFECT AND CAUSE,  
SIDE BAND MODULATION CHARACTERISTIC &  
SCALAR PASSBAND.

FIG (9) COMPOUND EN-HARMONIC SERIES, ODD ORDER  
QUARTER WAVE MULTIPLES, FORWARD & CONTRARY  
SLOPES WITH FREQUENCY & AMPLITUDE MODULATION  
SIDE BANDS.

5) EQUIVALENT CIRCUIT OF COMPENSATED TRANSFER  
TRANSMISSION, ALEXANDERSON TYPE

FIG (10) DOUBLE SIDEBAND / DUAL SLOPE ODD ORDER  
QUARTER WAVE RESONANT.

6) OBSERVATIONS, SIMPLE LINES

a) TRANSVERSE STRUCTURES EXHIBIT HARMONIC  
MULTIPLES IN RESONANT LINES (WIRES)

b) LONGITUDINAL STRUCTURES EXHIBIT HARMONIC  
DIVISIONS IN RESONANT LINES (STACKS)

c) TRANSVERSE DIMENSIONS, FORWARD FORWARD  
TIME, SPATIAL PROPAGATION

d) LONGITUDINAL DIMENSIONS, REVERSE TIME  
COUNTER, SPATIAL PROPAGATION

## 7) OBSERVATIONS, CONCA TENATED (COMPLEX) LINES

- a) SHUNT (TESLA TRANSFORMER) HARMONICS SIMILAR TO LONGITUDINAL LINE & SAME FOR HIGH PASS CHARACTER
- b) TRANSIENT FLOWS SMOOTHLY, STARTS WITH INSTANTANEOUS D.C. LEVEL, CLEAN DOWNWARD SWEEP OF OSCILLATORY FREQUENCY
- c) SERIES (ALEXANDERSON AERIAL) HARMONICS IN TWO GROUPS, ONE SIMILAR TO TRANSVERSE AND A SECOND SIMILAR TO LONGITUDINAL. NO D.C. START, SLOW OSCILLATORY BUILDUP. FACTORS FIGHTING EACH OTHER AND TRANSIENT ENDS AS NOISE
- d) DISTINCT FLAT PASS BAND REGION, STRONG MODULATOR LIKE CHARACTERISTICS INDICATING NON-LINEAR TRANSFORMATION.
- e) SERIES CONCA TENATED NETWORK APPEARS TO REQUIRE MORE CRITICAL BALANCING IN ORDER TO BE HARMONIOUS. SHUNT CONCA TENATED NETWORK A MORE NATURAL, OR HARMONIOUS RESPONSE.

## 8) CONCLUSIONS

- a) CAREFULL ENGINEERING OF CONCA TENATED ANALOG NETWORKS GIVE APPEARANCE OF ACTING AS MODULATORS, OR NON LINEAR TRANSMISSION STRUCTURES, THESE STRUCTURES CONSISTING OF LINEAR ELEMENTS, L, C, M, K.
- b) LIKEWISE, PROPERLY ENGINEERED NETWORK IS CAPABLE OF CREATING COMPLEX MUSICAL TONES FOR SYNTHESIZER USE.
- c) UNDERSTANDING GAINED FROM NETWORK STUDY MAY LEAD TO MORE ADVANCED KNOWLEDGE OF TRANSFORMER & WAVEGUIDE STRUCTURES IN THE TRANSMISSION & DISTORTION OF ELECTRIC WAVES.



ELEMENTAL  
TRANSVERSE TRANSMISSION  
NETWORK  
dl

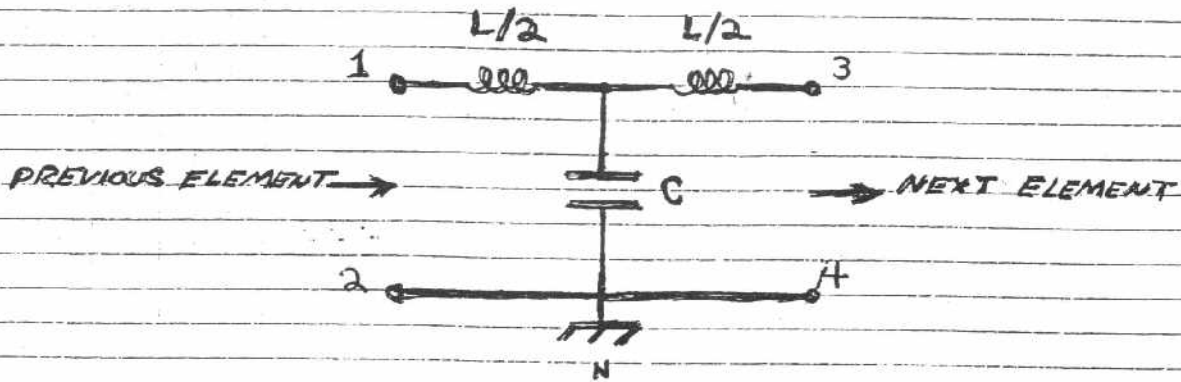

$$L = 40 \text{ mH} \quad C = 0.68 \text{ } \mu\text{F}$$

$$Z_c = 240 \Omega$$

$$Y_c = 0.04 \text{ S}$$

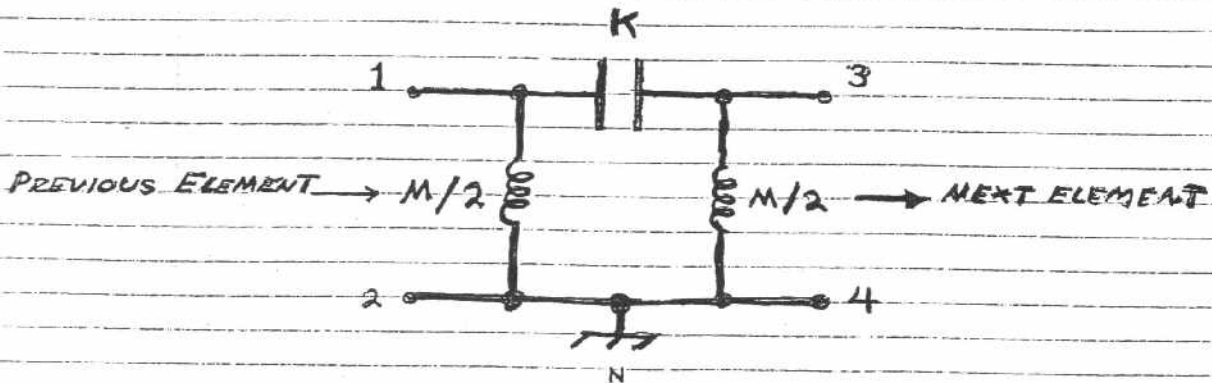

$$M = \frac{1}{40 \text{ mH}} \quad K = \frac{1}{0.68 \text{ } \mu\text{F}}$$

ELEMENTAL  
LONGITUDINAL TRANSMISSION  
NETWORK  
dl

**ELEMENTAL SERIES  
CONCATENATED TRANSMISSION  
NETWORK dl**

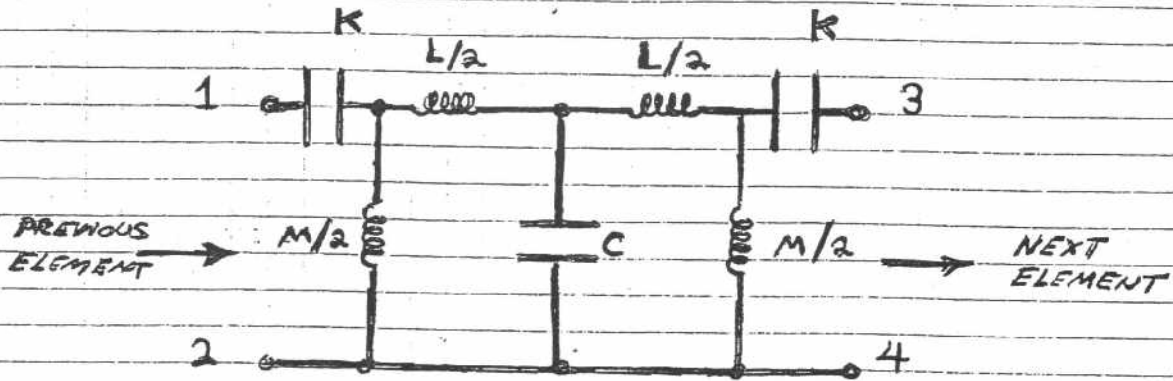

$$C = 1/K = 0.68 \mu\text{Fd}$$

$$L = 1/M = 40 \text{ mHy}$$

**ELEMENTAL SHUNT  
CONCATENATED TRANSMISSION  
NETWORK dl**

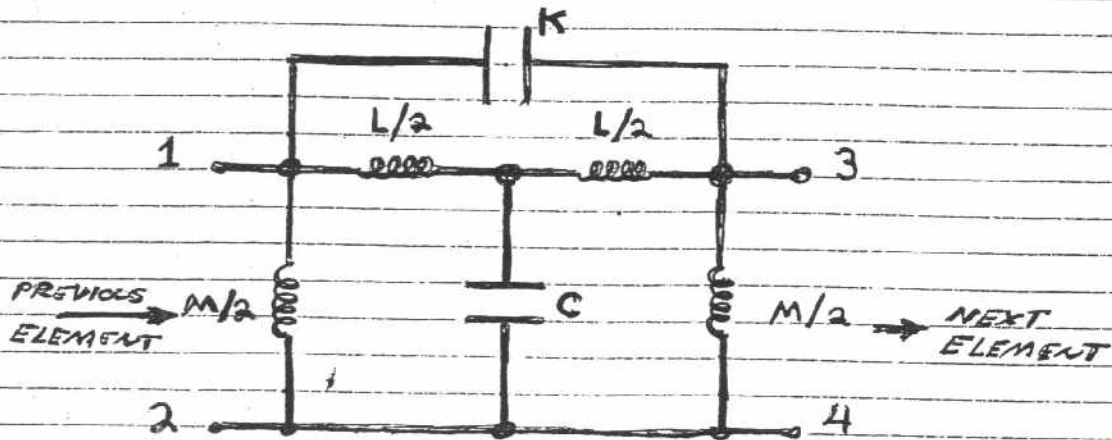

$$C = 1/K = 0.68 \mu\text{Fd}$$

$$L = 1/M = 40 \text{ mHy}$$



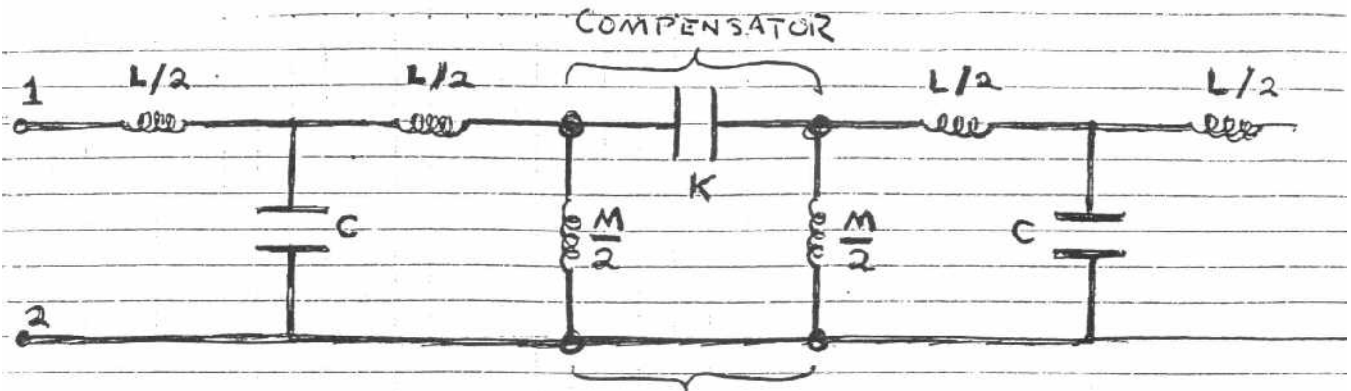

PARTIAL COMPENSATED TRANSVERSE TRANSMISSION NETWORK

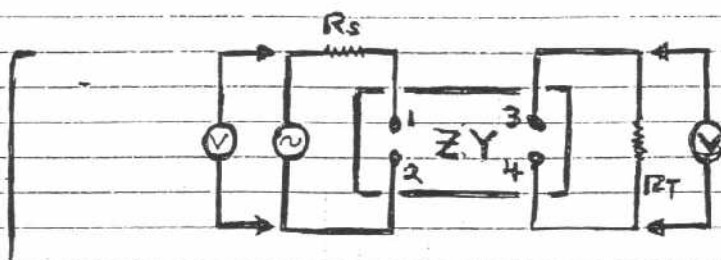

NETWORK TEST SET UP FOR MEASUREMENT

TERMINATED TRANSMISSION NETWORK,  $R_s = R_T = Z_0$

$$\frac{Z}{Y} = Z_0^2$$

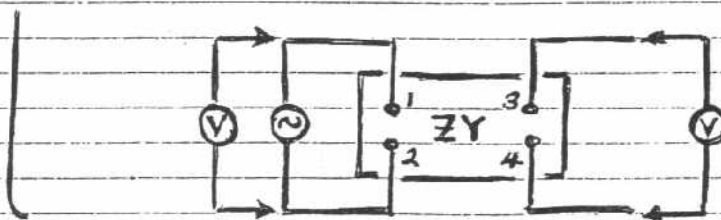

RESONANT TRANSMISSION NETWORK  $R_s < Z_0 < R_T$

$$R_T = \infty$$

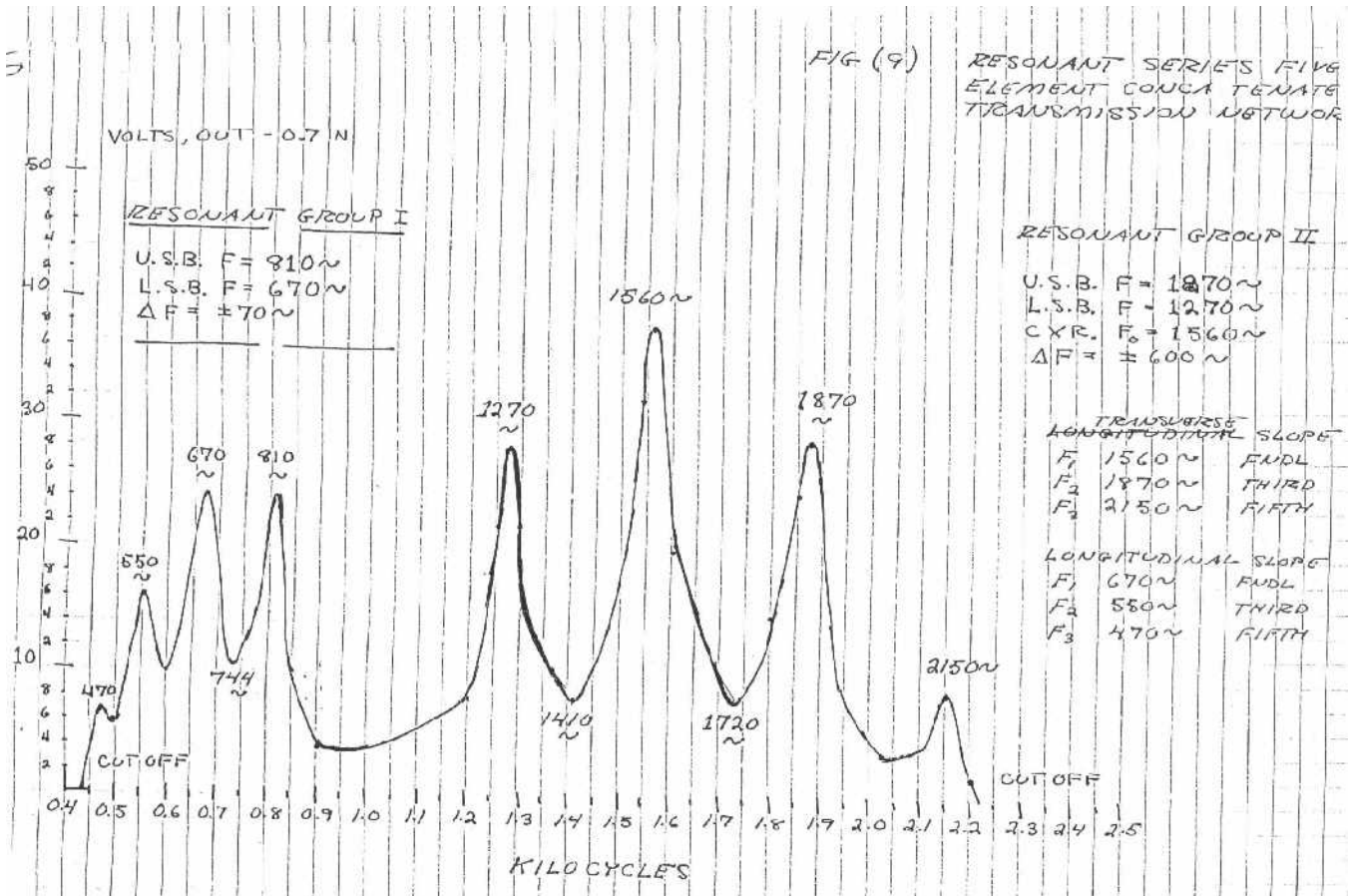
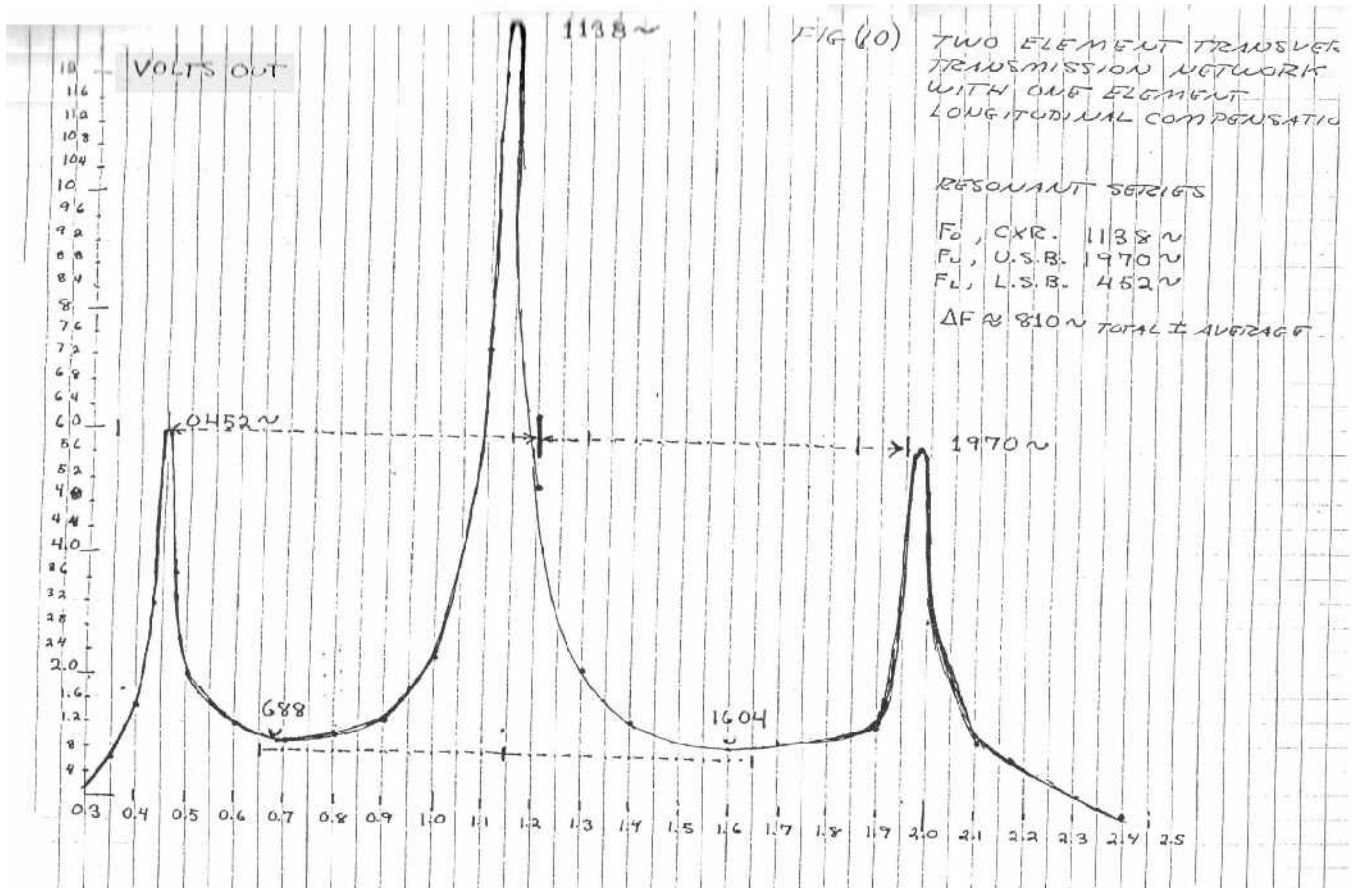



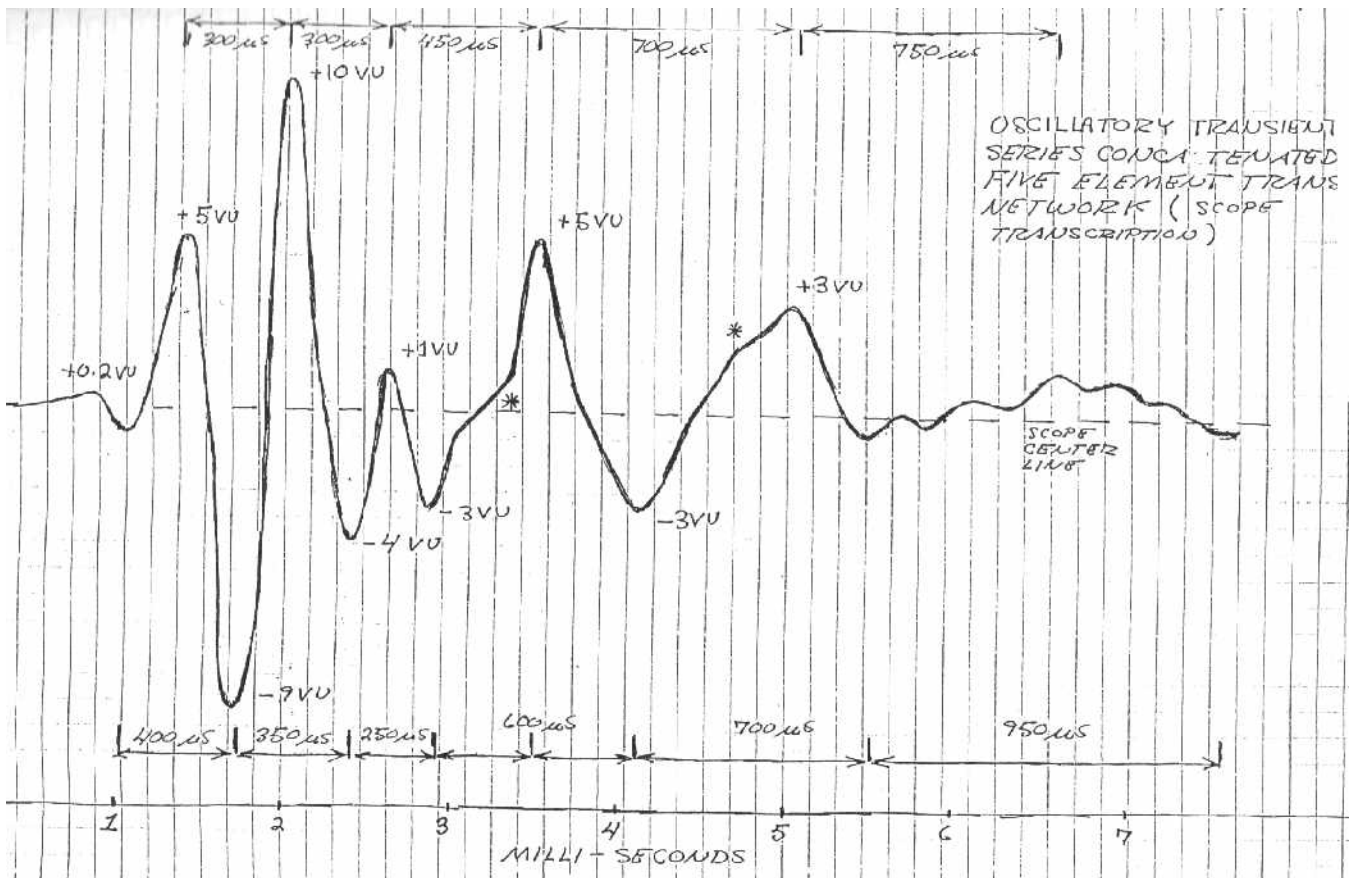
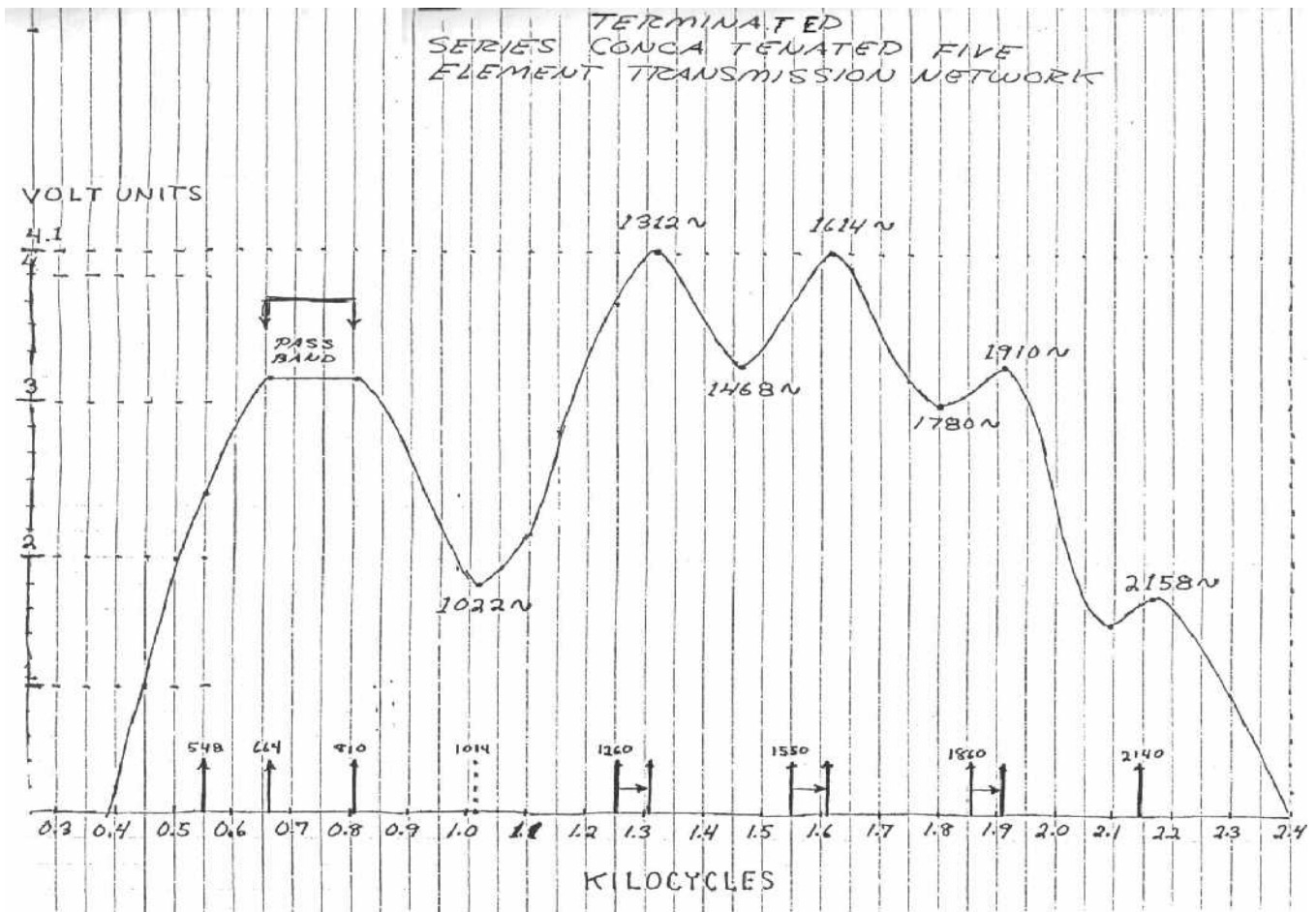

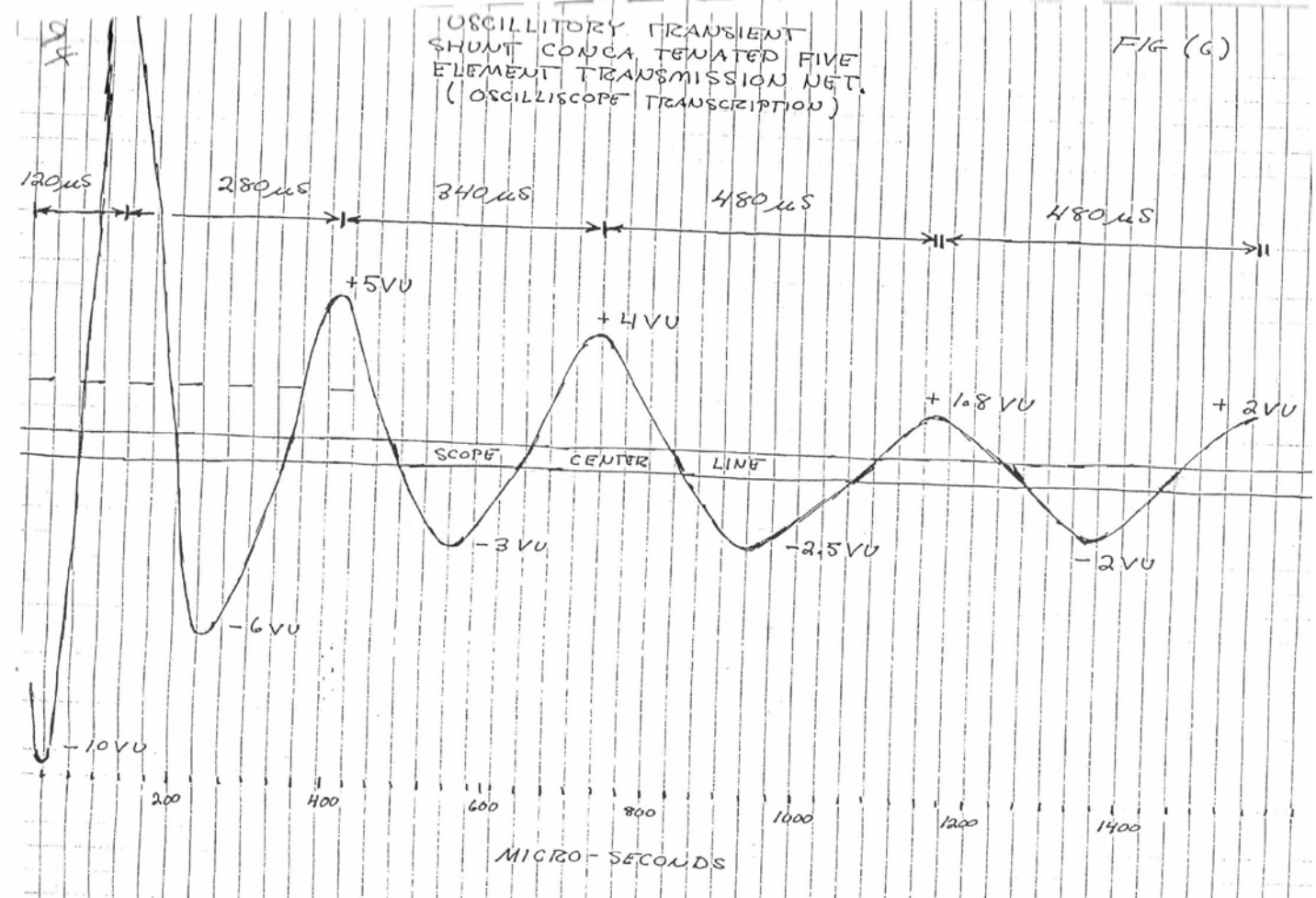
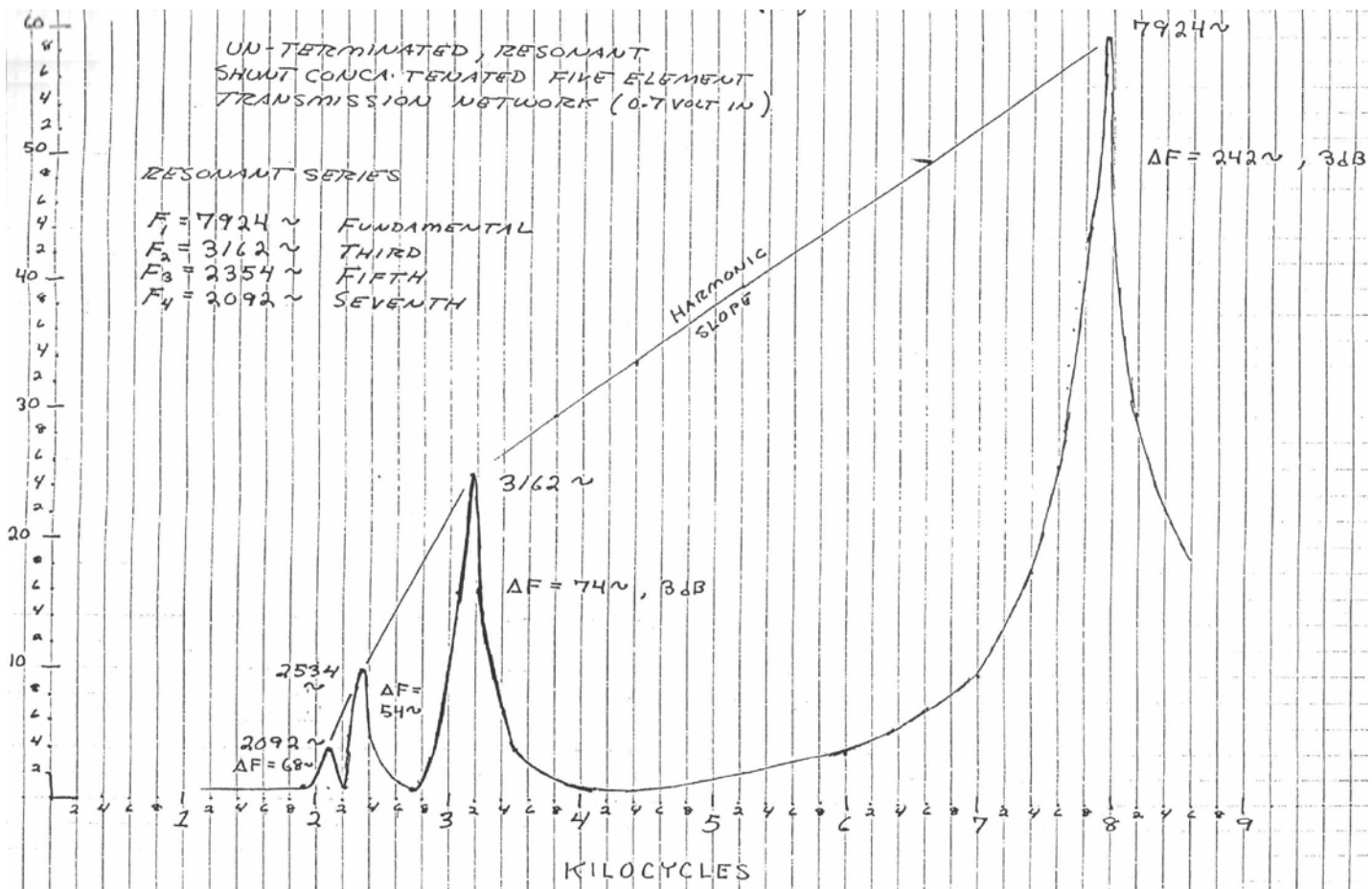



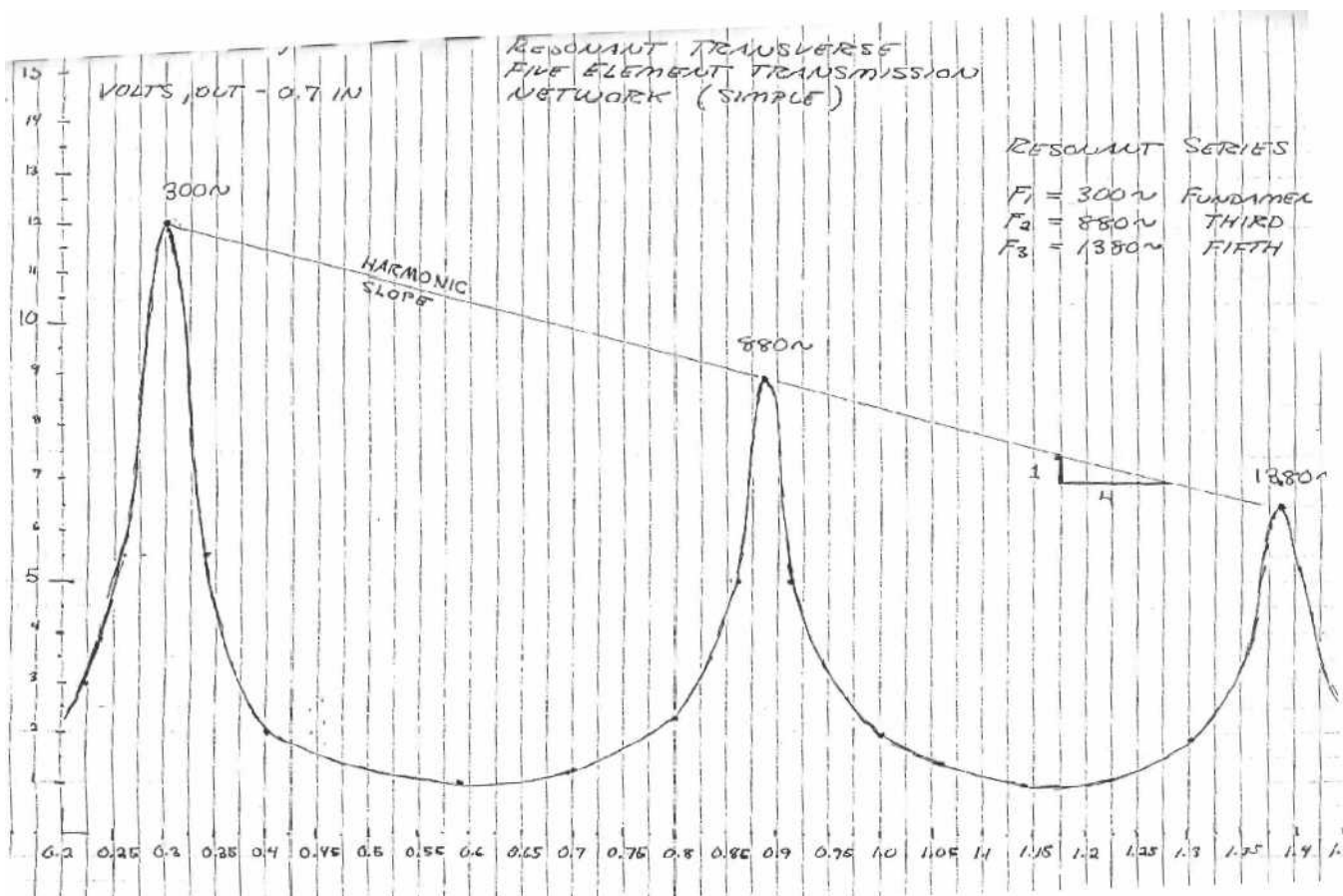
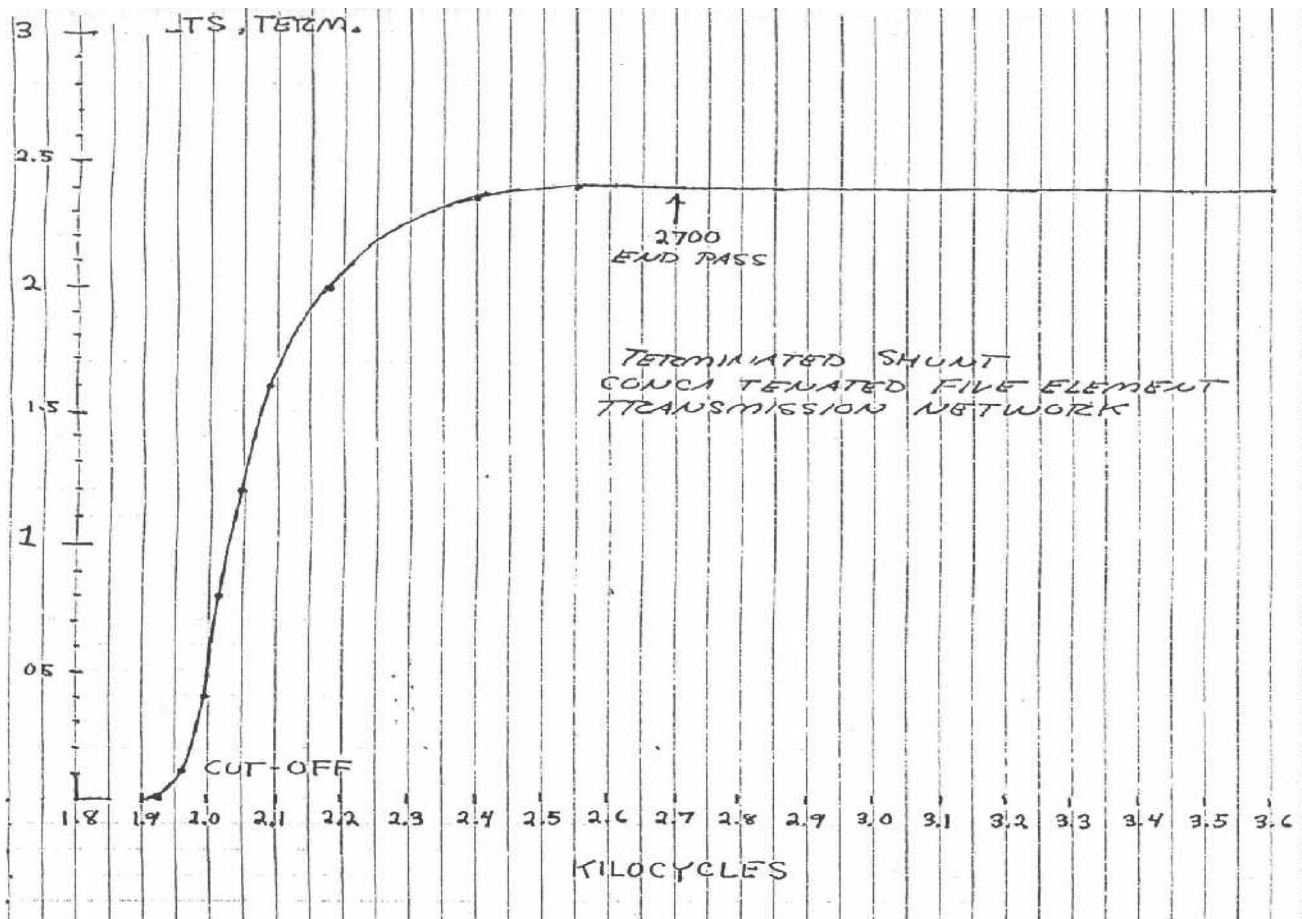

NO. 50 SIMPLE FIVE ELEMENT TRANSMISSION NETWORKS

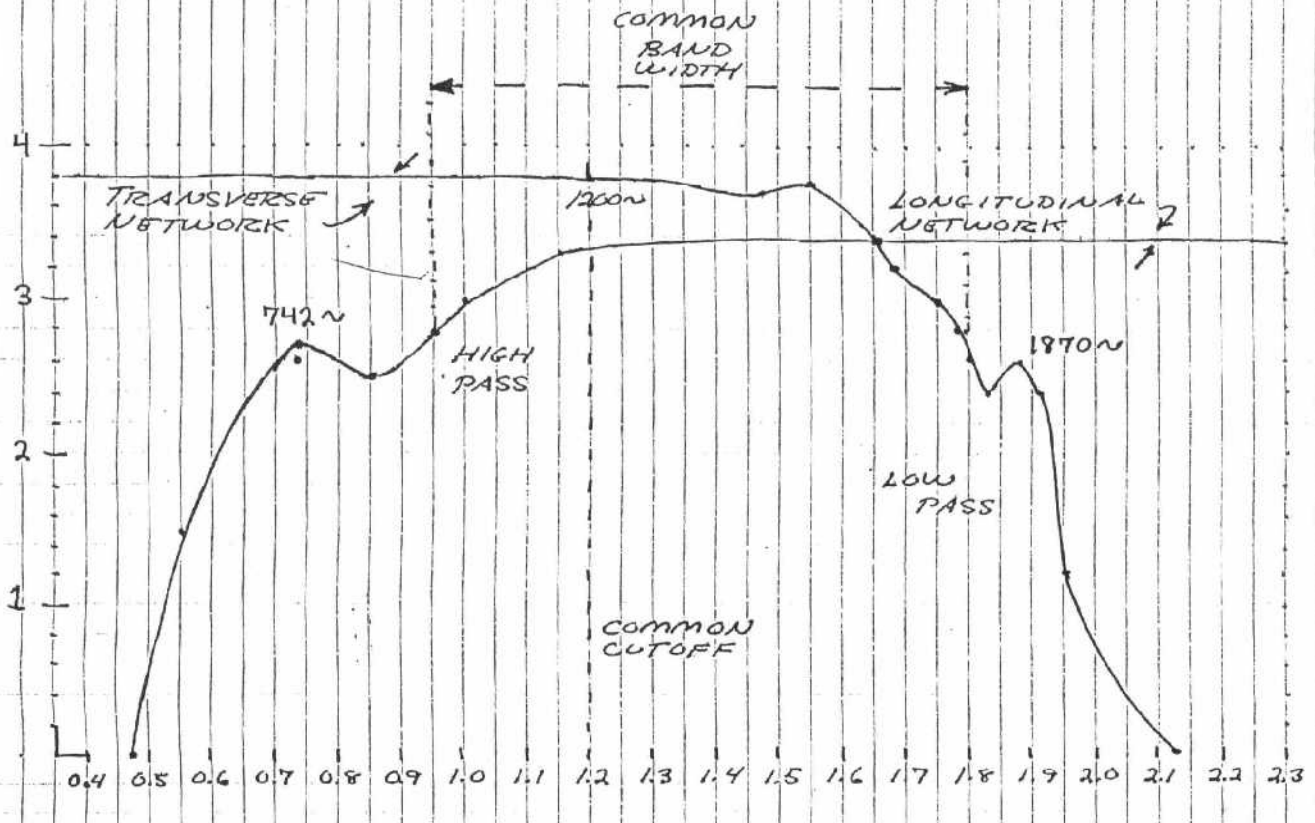



## APPENDIX II

IN THE INVESTIGATION OF THE ELECTRIC PHENOMENA THAT OCCUR IN RECURRENT ANTENNA STRUCTURES, HIGH FREQUENCY OSCILLATION TRANSFORMERS, OR ELECTRIC WAVE FILTERS, THESE ARE DEALT WITH AS LUMPED CONSTANT NETWORKS, THAT IS, AS SYSTEMS OF DISCRETE COILS & CONDENSERS, ANALYSIS IS FROM THE STANDPOINT OF ELECTRO-MAGNETIC CIRCUIT THEORY, BUT IN REALITY THE ELECTRIC CONSTANTS ARE OF A DISTRIBUTED FORM AND THE PHENOMENA IS IN THE FORM OF TRAVELLING WAVES, WHILE THE USE OF TRAVELLING WAVE THEORY IS COMMONPLACE IN THE STUDY OF ELECTRO-MAGNETIC TRANSMISSION LINES IT HAS NOT BEEN DEVELOPED FOR MORE COMPLEX STRUCTURES. THE WRITINGS OF THE PRINCIPLE GENERAL ELECTRIC SCIENTISTS, C.P. STEINMETZ AND L.V. BEWELY, HAVE LAYED IMPORTANT GROUNDWORK BUT FALL SHORT IN ESTABLISHING PRACTICAL FORMULAE. SO FAR NO ONE HAS TAKEN STEPS TO FINALISE THE EFFORTS OF THESE PIONEERS OF ELECTRICAL THEORY. IT IS THE AIM OF THIS PAPER TO INITIATE THE CONTINUATION OF THIS STUDY AND TO DEVELOP A BASIC TRANSMISSION THEORY CONSISTANT WITH THE FOUNDATION LAYED BY OLIVER HEAVISIDE & ARTHUR KENNELY. THRU THIS STUDY NEW CONCEPTS IN RADIO THEORY & PRACTICE AS WELL AS THE GENERATION & REPRODUCTION OF MUSICAL WAVE-FORMS WILL RESULT. THE RECENT STRIVING FOR NEW TYPES OF VACUUM TUBE AUDIO EQUIPMENT AS WELL AS RENEWED INTEREST IN THE WORKS OF EQUIMATIC VICTORIAN PHILOSOPHERS SUCH AS TESLA, & EVEN KEELY HAVE GIVEN IMPETUS FOR ADVANCEMENT.

THE PRINCIPLE OBSTACAL IN THIS STUDY IS THE QUADRUPLE ENERGY STORAGE CHARACTER OF THESE NETWORKS. THIS LEADS TO FOURTH ORDER DIFFERENTIAL EQUATIONS WHICH FIND NO SOLUTION IN OUR LIMITED SYSTEM OF ALGEBRA. A SIMPLE PAIR OF COUPLED TUNED CIRCUITS DEMONSTRATES THIS PROBLEM, AND APPROXIMATION OR CONTRIVANCE MUST BE RESORTED TO FOR ANALYSIS. THRU ANALOGY & SYMBOLIC REPRESENTATION THE ARCHETYPAL TELEGRAPH EQUATION OF HEAVISIDE, & THE ANALOG COMPUTING NETWORKS OF KENNELY CAN BE ADAPTED TO A QUANTIFICATION OF WAVE COMPLEXES. THE FOLLOWING MATHEMATICAL PROPOSITIONS SHOULD IN NO WAY BE CONSTRUED AS FINALISED SOLUTIONS BUT ARE GIVEN AS VISUALIZATION AIDS TO THE STUDY OF THE INVOLVED PROCESSES.



LET THE GENERALIZED ELECTRIC WAVE PROPAGATION BE REPRESENTED BY THE FOLLOWING FIGURE;

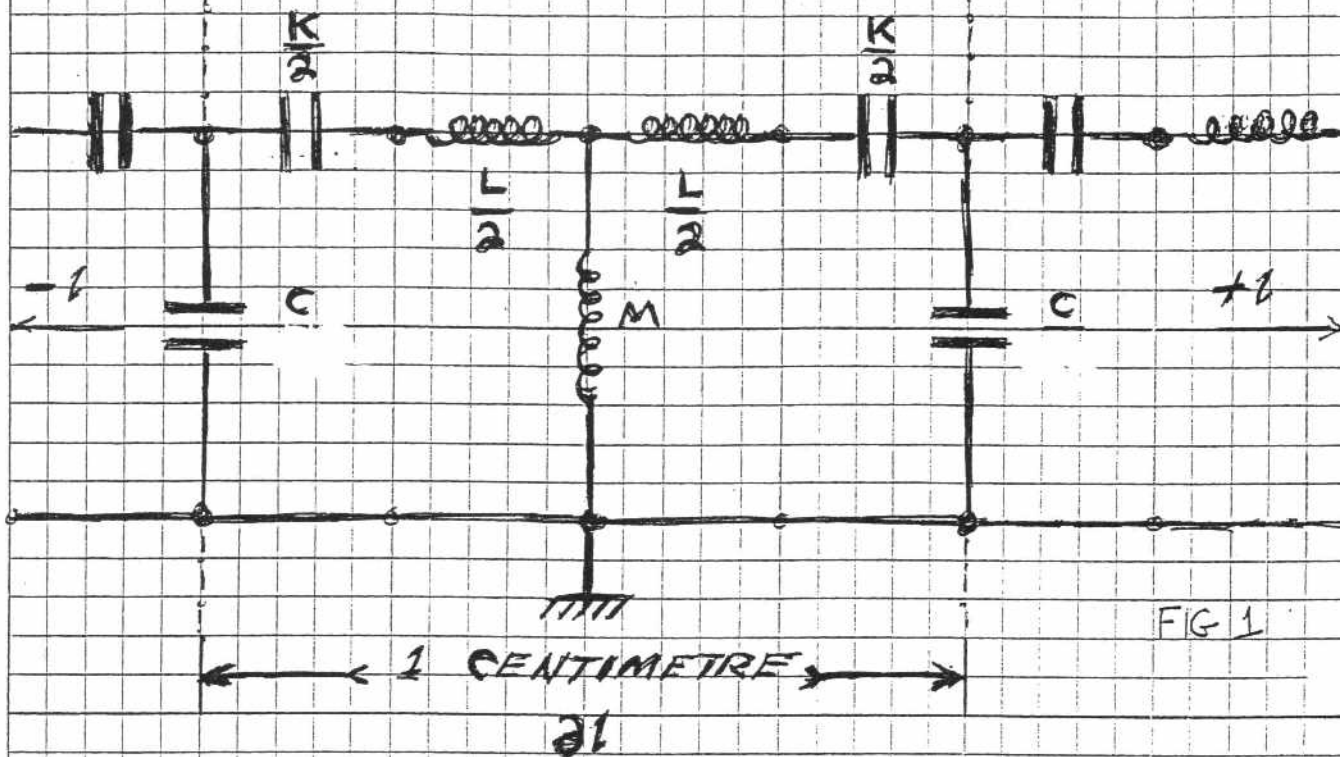

WHERE

**C** IS THE COEFFICIENT OF DIELECTRIC INDUCTION TRANSVERSE TO THE DIRECTION OF PROPAGATION IN FARADS PER CENTIMETRE,

**K** IS THE COEFFICIENT OF DIELECTRIC INDUCTION LONGITUDINAL WITH THE DIRECTION OF PROPAGATION IN PER FARAD CENTIMETRE,

**L** IS THE COEFFICIENT OF MAGNETIC INDUCTION TRANSVERSE TO THE DIRECTION OF PROPAGATION IN HENRYS PER CENTIMETRE,

**M** IS THE COEFFICIENT OF MAGNETIC INDUCTION LONGITUDINAL WITH THE DIRECTION OF PROPAGATION IN PER HENRY CENTIMETRE



THESE COEFFICIENTS ARE DEFINED BY THE ESTABLISHED CONVENTIONAL PHYSICAL DIMENSIONS,

$$C = \frac{e^2}{l^3} \text{ SEC}^2 \text{ PER CM}^3 \quad (1)$$

$$K = \frac{1}{t^2} \text{ CM PER SEC}^2 \quad (2)$$

$$L = l \text{ CM} \quad (3)$$

$$M = \frac{1}{l^3} \text{ PER CM}^3 \quad (4)$$

LET THE SHUNT COEFFICIENTS BE COMBINED BY THE RELATION

$$M + u_1^2 C = \frac{M + 1}{(kw)^2} C \quad (5)$$

AND LET THE SERIES COEFFICIENTS BE COMBINED BY THE RELATION

$$K - u_1^2 L = \frac{K - 1}{(kw)^2} L \quad (6)$$

WHERE THE FACTOR

$$u^2 = (kw)^2 \text{ PER SEC}^2 \quad (7)$$

AND

$$\omega = 2\pi F \text{ PER SEC}$$

$$k^H = -1, \text{ A DIMENSIONLESS UNIT.}$$

$$k^H = -1$$

THE PRODUCT OF EQ (5) & EQ (6) GIVES THE COMPLETE ALGEBRAIC EXPRESSION OF THE ELEMENTAL SECTION IN FIGURE(1)

$$(M + u_1^2 C) (K - u_2^2 L) = \Gamma^4 \quad (8)$$

AND CARRYING THRU THE PRODUCTS GIVES THE RELATION

$$\Gamma^4 = [MK + (u_1^2 u_2^2) LC] + [u_1^2 CK - u_2^2 LM] \quad (9)$$

EQ (9) REPRESENTS THE FOURTH ORDER DIFFERENTIAL EQUATION OF THE COMPLEX PROPAGATION THRU THE ELEMENT, FIG (1).

IT WILL BE SEEN THAT EQ (9) IS DIRECTLY ANALOGOUS WITH THE HEAVISIDE TELEGRAPH EQUATION,

$$\begin{aligned} (R + u_0 L)(G - u_0 C) &= \Gamma^2 \\ &= (RG + u_0^2 LC) + u_0 (LG - RC) \end{aligned} \quad (10)$$

WHERE

R IS THE SERIES RESISTANCE IN OHMS PER CM

AND

G IS THE SHUNT CONDUCTANCE IN PER OHM CM



THE FOUR COMPONENTS OF EQ (9) ARE THUS,

I) MK REPRESENTS THE LONGITUDINAL WAVE OF ELECTRIC INDUCTION, AND BY EQ (2), (4) IT IS DEFINED

$$MK = \frac{1}{l^2 t^2}, \text{ PER CM}^2 \text{ SEC}^2 \quad (11)$$

II) LC REPRESENTS THE TRANSVERSE WAVE OF ELECTRIC INDUCTION, AND BY EQ (1), (3) IT IS DEFINED

$$LC = \frac{t^2}{l^2}, \text{ SEC}^2 \text{ PER CM}^2 \quad (12)$$

III) CK REPRESENTS THE DISTRIBUTION OF DIELECTRIC INDUCTION, AND BY EQ (1), (2) IT IS DEFINED

$$CK = \frac{1}{l^2}, \text{ PER CM}^2 \quad (13)$$

IV) LM REPRESENTS THE DISTRIBUTION OF MAGNETIC INDUCTION, AND BY EQ (3), (4) IT IS DEFINED

$$LM = \frac{1}{l^2}, \text{ PER CM}^2 \quad (14)$$

THE INTERACTION OF THE LONGITUDINAL WAVE (MK) WITH THE TRANSVERSE WAVE (LC) IS REPRESENTED BY THE FACTORS  $\omega_1^2$  &  $\omega_2^2$  WHERE,

$L/K = \omega_1^{-2}$  REPRESENTS THE TIME CONSTANT OF THE SERIES COEFFICIENTS AND BY EQ (2), (3) IT IS DEFINED

$$L/K = \text{PER SEC}^{-2} \quad (15)$$

$C/M = \omega_2^{-2}$  REPRESENTS THE TIME CONSTANT OF THE SHUNT COEFFICIENTS AND BY EQ (1), (4)

$$C/M = \text{PER SEC}^{-2} \quad (16)$$

THE FACTOR (MK) REPRESENTS WAVE PROPAGATION THRU COUNTER SPATIAL DISTANCE, PER CM. OVER TIME PERIOD, SEC.

THE FACTOR (LC) REPRESENTS WAVE PROPAGATION THRU SPATIAL DISTANCE, CM. OVER TIME PERIOD, SEC.

THE FACTOR (CK) DOES NOT PROPAGATE, BUT IS A DISTRIBUTION OVER DISTANCE CM, AND LIKEWISE LM DOES NOT PROPAGATE, BUT IS A DISTRIBUTION OVER DISTANCE CM. THESE FACTORS ARE TIME SCALARS, THAT IS, NO VARIATION EXISTS IN THE DIMENSION OF TIME.

THE FACTOR (L/K) OSCILLATES WITH NO VARIATION OVER DISTANCE CM., AND LIKEWISE (C/M) OSCILLATES WITH NO VARIATION OVER DISTANCE. THESE FACTORS ARE FREQUENCIES, OR TIME FACTORS OF  $\text{SEC}^{-1}$  AND ARE SPACE SCALARS.



IN TERMS OF CIRCUIT ELEMENTS THESE TERMS ARE REPRESENTED BY

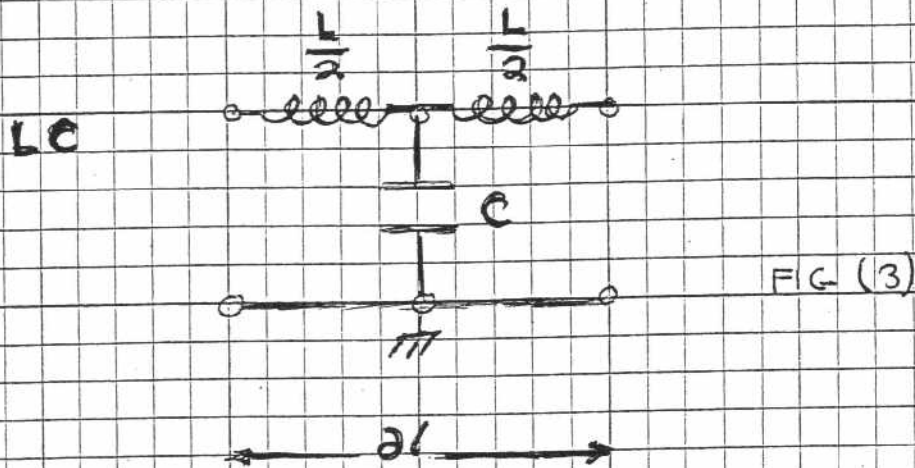
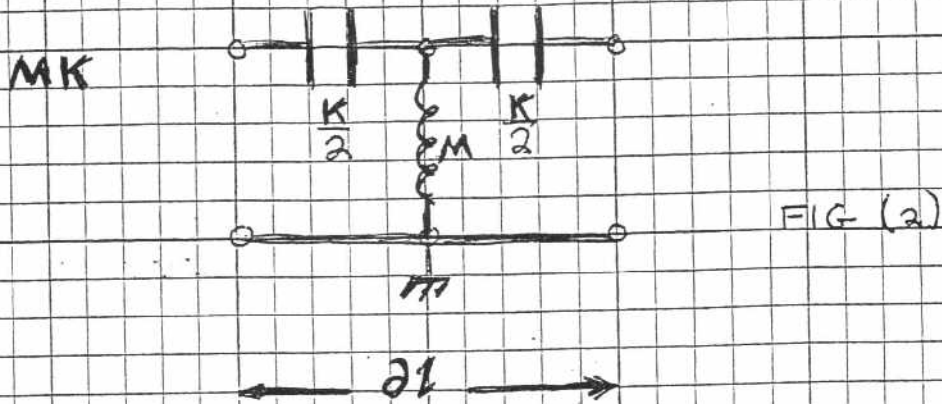

(MK) CAN BE SEEN AS A FUNDAMENTAL HIGH PASS SECTION OR PHASE LEAD NETWORK, AND BECOMES TRANSPARENT TO PROPAGATION FOR

$$\frac{\partial}{\partial t} \rightarrow \infty$$

(LC) CAN BE SEEN AS A FUNDAMENTAL LOW PASS SECTION OR PHASE LAG NETWORK, AND BECOMES TRANSPARENT TO PROPAGATION FOR

$$\frac{\partial}{\partial t} \rightarrow 0$$

LIKEWISE

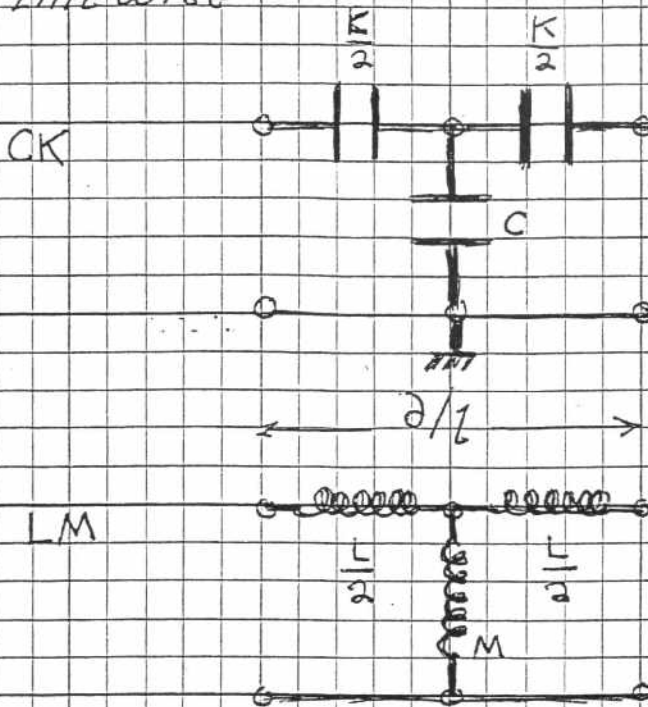
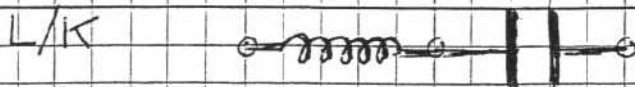
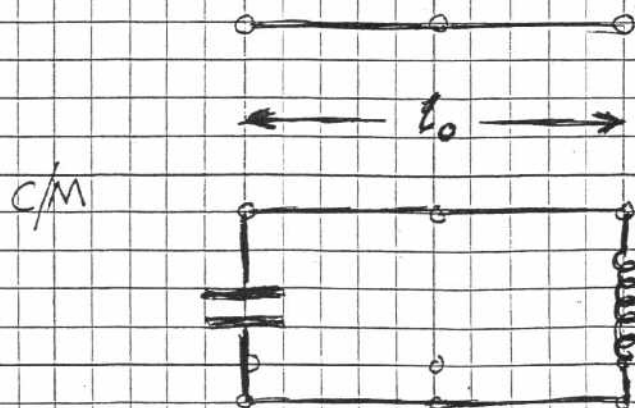

FIG (4)

WHERE (CK) & (LM) DO NOT PROPAGATE BUT ARE INSTANTANEOUS DISTRIBUTIONS OF THE DIELECTRIC & MAGNETIC FIELDS OF INDUCTION RESPECTIVELY, INSTANTANEOUS ACTION IS CARRIED THRU K IN THE DIELECTRIC DISTRIBUTION & M IN THE MAGNETIC DISTRIBUTION. AND FINALLY



SERIES RESONANCE



PARALLEL RESONANCE

FIG (5)



WHERE  $(L/K)$  &  $(C/M)$  DO NOT PROPAGATE BUT ARE THE SERIES & PARALLEL RESONANT FREQUENCIES OF THE ENTIRE ELECTRICAL NETWORK OF LENGTH  $l_0$ .

IN GENERAL ANY ELECTRICAL NETWORK OF THE FORM IN FIG (1) WILL EXHIBIT A PAIR OF FREQUENCIES WHICH MAY BE DISSONANT OR CONSONANT DEPENDING ON THE RELATION BETWEEN  $(LM)$  AND  $(CK)$ . IF SUCH A NETWORK IS TERMINATED IN ITS IMAGE IMPEDANCE & ADMITTANCE IT WILL EXHIBIT A BAND PASS CHARACTERISTIC PASSING A DEFINITE WINDOW OF FREQUENCIES.

THE FREQUENCIES WILL BE IN UNISON IF THE CONDITION

$$L/K = C/M \quad (17)$$

EXISTS, OR TRANSPOSING,

$$LM = CK \quad (18)$$

THAT IS, IF THE DISTRIBUTION OF MAGNETIC INDUCTION EXACTLY MATCHES THE DISTRIBUTION OF DIELECTRIC INDUCTION, THE NETWORK IS THEN DISTORTIONLESS.

CONVERSELY, IF  $(L/K)$  OR  $(C/M)$  IS MADE TO VANISH, LEAVING ONLY ONE OR THE OTHER, SUCH AS WITH CADUCEOUS WOUND NETWORKS OR LUMPED CONSTANTS ONLY A SINGLE FREQUENCY EXISTS AND THE NETWORK IS SPACE SCALAR.

THE PROPAGATION OF THE LONGITUDINAL & TRANSVERSE WAVES ARE GIVEN BY THE RELATIONS

$$\dot{A} = \dot{A}_0 (\cos \beta_1 l \pm j \sin \beta_1 l) \quad (19)$$

OR

$$\dot{B} = \dot{B}_0 (\cos \beta_2 l \pm j \sin \beta_2 l) \quad (20)$$

WHERE THE PROPAGATION CONSTANTS ARE DEFINED BY

$$\left. \begin{aligned} \beta_1 &= \sqrt{MK} \text{ , LONGITUDINAL} \\ \beta_2 &= \sqrt{LC} \text{ , TRANSVERSE} \end{aligned} \right\} (21)$$

THE MAGNETIC & DIELECTRIC DISTRIBUTIONS ARE GIVEN BY THE RELATIONS

$$\left. \begin{aligned} C &= C_0 (\cosh \alpha_1 l \pm h \sinh \alpha_1 l) \\ D &= D_0 (\cosh \alpha_2 l \pm h \sinh \alpha_2 l) \end{aligned} \right\} (22)$$

AND, THE OSCILLATIONS ARE GIVEN BY

$$\left. \begin{aligned} \dot{E} &= \dot{E}_0 (\cos \omega_1 t \pm j \sin \omega_1 t) \\ \dot{F} &= \dot{F}_0 (\cos \omega_2 t \pm j \sin \omega_2 t) \end{aligned} \right\} (23)$$

WHERE

$$\left. \begin{aligned} \alpha_1 &= \sqrt{LM} & \omega_1 &= \sqrt{\frac{K}{L}} \\ \alpha_2 &= \sqrt{CK} & \omega_2 &= \sqrt{\frac{M}{C}} \end{aligned} \right\} (24)$$

AND

$$h^2 = +1 \quad j^2 = -1 \quad (25)$$



LET A SYSTEM OF ANALOG NETWORKS BE CONSTRUCTED FROM THE FOLLOWING ELEMENTAL CIRCUIT SECTIONS;

### I) TRANSVERSE ELEMENT

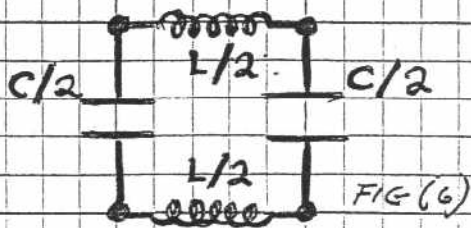

$$L = 8.0 \times 10^{-2} \text{ HENRY}$$

$$C = 2.0 \times 10^{-8} \text{ FARAD}$$

THE TRANSMISSION IMPEDANCE IS GIVEN BY

$$Z_c = \sqrt{L/C} = 2 \times 10^3 \text{ OHM} \quad (26)$$

THE PROPAGATION CONSTANT IS GIVEN BY

$$\gamma_T = \sqrt{LC} = 4 \times 10^{-5} \text{ SEC PER CM} \quad (27)$$

### II) LONGITUDINAL ELEMENT

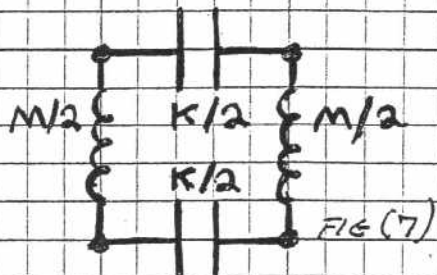

$$M = 5.0 \times 10^{-1} \text{ PER HENRY}$$

$$K = 2.0 \times 10^{-8} \text{ PER FARAD}$$

THE TRANSMISSION ADMITTANCE IS GIVEN BY

$$Y_c = \sqrt{M/K} = 4.7 \times 10^3 \text{ PER OHM} \quad (28)$$

THE PROPAGATION CONSTANT IS GIVEN BY

$$\gamma_L = \sqrt{MK} = 1.0 \times 10^{-5} \text{ PER SEC CM} \quad (29)$$

LET A PAIR OF RECURRENT, OR LADDER NETWORKS BE CONSTRUCTED FROM THE ELEMENTS OF FIG (6) & FIG (7), THESE NETWORKS SERVING AS ANALOGS OF TRANSVERSE & LONGITUDINAL WAVE PROPAGATION. 20 COILS & 20 CONDENSERS MAKE UP EACH NETWORK, THE COILS BEING 40mHY, 5% UNITS AND THE CONDENSERS BEING 0.01  $\mu$ Fd 20% UNITS. THE ELEMENTS ARE CONNECTED AS FOLLOWS

THE TRANSVERSE NETWORK

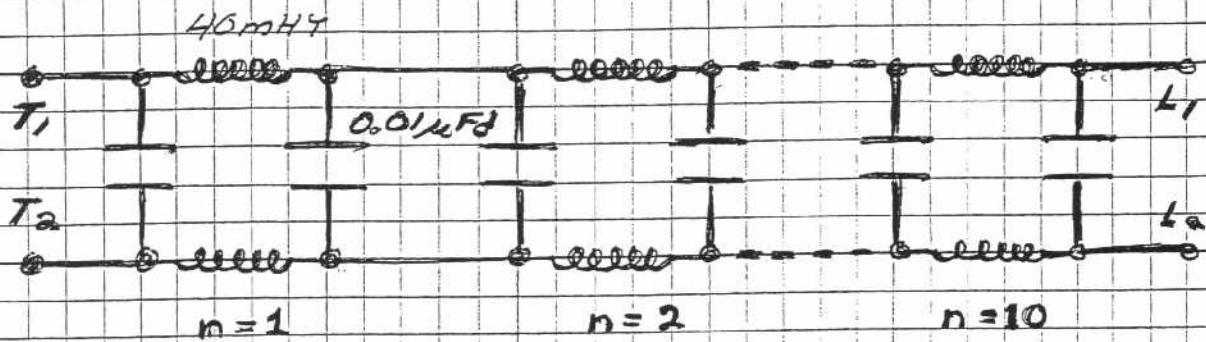

FIG (8)

THE LONGITUDINAL NETWORK

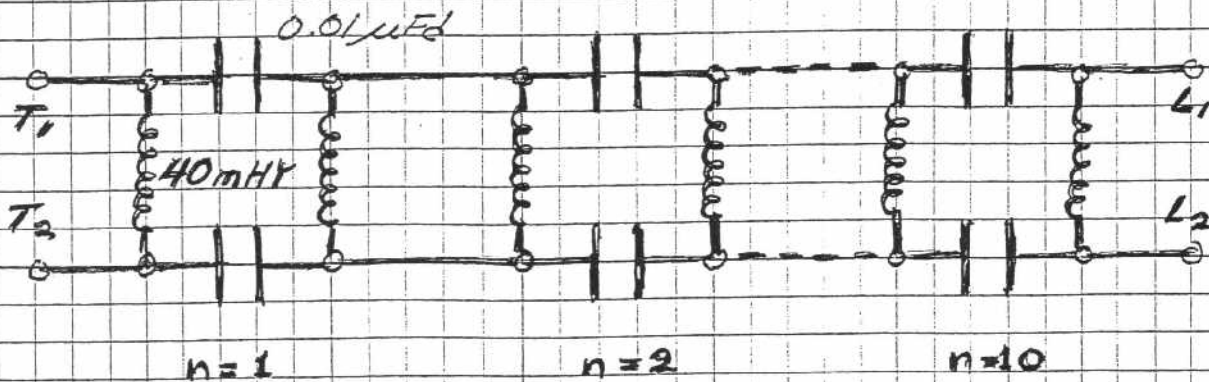

FIG (9)



THE TRANSVERSE NETWORK IS NOW CONNECTED IN THE FOLLOWING MANNER



FIG (10)

AS THE FREQUENCY OF THE SOURCE  $E_0$  IS VARIED IT IS SEEN THAT THE NETWORK EXHIBITS THE CHARACTER OF A LOW PASS FILTER. THE CUTOFF FREQUENCY IS FOUND TO BE OF THE VALUE 6 KILOCYCLES PER SECOND, THAT IS, THE NETWORK WILL NOT TRANSMIT FREQUENCIES ABOVE THIS VALUE.

RECONNECTING THE NETWORK AS FOLLOWS GIVES A QUARTER WAVE RESONANT CONDITION



FIG (11)

IT IS FOUND THAT THE RESONANT FREQUENCY OF THE NETWORK IS OF THE VALUE 52 KILOCYCLES PER SECOND. SINCE TRANSVERSE PROPAGATION IS EFFECTED AT THE VELOCITY OF LIGHT, THE EFFECTIVE LENGTH OF NETWORK  $\gamma_T$  IS GIVEN BY THE RELATION

$$l_0 = v_c / 4F_0 \quad \text{CM} \quad (30)$$

$$l_0 = 1.4 \times 10^{+5} \quad \text{CM}$$

$$\text{OR } l_0 = 2180 \text{ FEET}$$



THE LONGITUDINAL NETWORK IS NOW CONNECTED IN THE SAME MANNER AS SHOWN IN FIG (10), THAT IS, IT IS TERMINATED IN ITS CHARACTERISTIC ADMITTANCE  $Y_0$ . AS THE FREQUENCY OF SOURCE  $E_0$  IS VARIED IT IS SEEN THAT THE NETWORK EXHIBITS THE CHARACTER OF A HIGH PASS FILTER. THE CUTOFF FREQUENCY IS FOUND TO BE OF THE VALUE OF 10 KILOCYCLES PER SECOND, THAT IS, THE NETWORK WILL NOT TRANSMIT FREQUENCIES BELOW THIS VALUE.

RECONNECTING THE NETWORK IN THE MANNER OF FIG (11) GIVES THE QUARTER WAVE RESONANCE CONDITION. IT IS FOUND THAT THE RESONANT FREQUENCY IS OF THE VALUE OF 83 KILOCYCLES PER SECOND. SINCE LONGITUDINAL PROPAGATION IS DEFINED AS

$$\gamma_L^{-1} = \frac{1}{\ell t} \quad \text{PER CM SEC} \quad (31)$$

THIS PROPAGATION IS NOT EFFECTED AS A VELOCITY IN THE MANNER OF THE TRANSVERSE

$$\gamma_T^{-1} = \frac{t}{1} \quad \text{SEC PER CM} \quad (32)$$

THE VALUE OF THE CONSTANT  $(\ell t)$  IS NOT YET KNOWN, BUT TAKING THE RATIO OF FREQUENCIES GIVES THE EFFECTIVE VELOCITY OF LONGITUDINAL PROPAGATION AS

$$(F_0)_L \div (F_0)_T = \frac{\pi}{2} \quad (33)$$

THAT IS, LONGITUDINAL PROPAGATION HAS AN EFFECTIVE VELOCITY OF  $\pi/2$  TIMES THAT OF THE SPEED OF LIGHT, THE SAME VELOCITY AS GIVEN BY NIKOLA TESLA IN HIS WIRELESS PATENTS.

UPON EXAMINATION OF THE RESONANCE CURVES OF EACH NETWORK, THE TRANSVERSE & THE LONGITUDINAL IT IS FOUND THAT THE LONGITUDINAL RESONANCE IS VERY MUCH STRONGER. THIS INDICATES THAT THE LOSSES INVOLVED IN LONGITUDINAL TRANSMISSION IS MUCH LESS, DESPITE THE SAME COIL RESISTANCE & CONDENSER CONDUCTANCE, A REMARKABLE CONDITION.



WITH REGARD TO THE PROPAGATION CONSTANT

$$\gamma_L^{-1} = \frac{1}{2t}$$

THE FOLLOWING EXPERIMENT WAS CONDUCTED TO DETERMINE IF IT WAS INVARIANT AS IS THE TRANSVERSE & THE SPEED OF LIGHT. A PAIR OF SPIRAL TESLA COILS WERE CONSTRUCTED OF EQUAL CONDUCTOR LENGTH  $l_0$ , SPACE BETWEEN TURNS  $l_s$ , AND DIAMETER  $l_d$ . ONE COIL WAS WOUND WITH ROUND CONDUCTOR OF SMALL DIAMETER, THE OTHER WITH WIDE FLAT STRIP. THE CONDUCTOR MASS & INTER-TURN CAPACITANCE THUS WAS MUCH GREATER IN THE LATTER COIL, LEADING ONE TO CONCLUDE THAT IT WOULD HAVE A MUCH LOWER RESONANT FREQUENCY. THIS WAS NOT SO HOWEVER, THE FREQUENCIES WERE IN REALITY IDENTICAL. IT CAN THEREFORE BE CONCLUDED THAT LONGITUDINAL PROPAGATION IS BASED UPON A UNIVERSAL CONSTANT AS IS THE TRANSVERSE & LUMINAL VELOCITY.

MEASUREMENT OF THE PHASE ANGLE ALONG THE TRANSVERSE NETWORK SHOWS THE TIME LAG, THAT IS HOW MUCH LATER THE WAVE APPEARS AT A GIVEN DISTANCE. THIS LAG IS OF THE MAGNITUDE OF 32 MICROSECONDS PER ELEMENT IN THE TRANSVERSE NETWORK.

LIKEWISE MEASUREMENT OF THE PHASE ANGLE ALONG THE LONGITUDINAL NETWORK SHOWS THE TIME LEAD, THAT IS HOW MUCH EARLIER THE WAVE APPEARS AT A GIVEN DISTANCE. THIS LEAD IS OF THE MAGNITUDE OF 1.8 MICROSECONDS PER ELEMENT IN THE LONGITUDINAL NETWORK. 0.3 USEC.

HENCE, THE REMARKABLE CONDITION EXIST WHEREAS IN THE TRANSVERSE WAVE, THE WAVE APPEARS AT A GIVEN TIME AFTER INITIATION AT A GIVEN DISTANCE BUT, IN THE LONGITUDINAL WAVE, THE WAVE APPEARS AT A GIVEN TIME BEFORE INITIATION AT A GIVEN DISTANCE.



THAT IS, IN A TRANSVERSE WAVE CAUSE PRECEEDS EFFECT, BUT IN A LONGITUDINAL WAVE EFFECT PRECEED CAUSE.

FROM EQ (27) THE PROPAGATION CONSTANT FOR THE TRANSVERSE WAVE IS

$$\gamma_T = 4 \times 10^{-5} \text{ SEC/CM}$$

AND  
THE TIME LAG

$$t = 3.2 \times 10^{-5} \text{ SEC}$$

ERROR  
DELETE

THIS GIVES THE ELEMENTAL DISTANCE AS

$$l = 1.23 \text{ CM}$$

THUS, THE VELOCITY OF PROPAGATION IS

$$v_0 = l/t \cong 4 \times 10^{+4} \text{ CM PER SEC}$$

LIKEWISE, FROM EQ (29) THE PROPAGATION CONSTANT FOR THE LONGITUDINAL WAVE IS

$$\gamma_L = 1.0 \times 10^{+5} \text{ PER SEC CM}$$

THIS GIVES THE ELEMENTAL DISTANCE AS

$$l^{-1} = 1.2 \text{ PER CM}$$

THUS, THE CONTRA-VELOCITY OF PROPAGATION IS

$$v_0 = 1/l \cong 8.3 \times 10^{+4} \text{ PER CM SEC}$$



COMBINING THE TRANSVERSE ELEMENT WITH THE LONGITUDINAL ELEMENT GIVES THE ELEMENT OF CONJUGATE PROPAGATION,

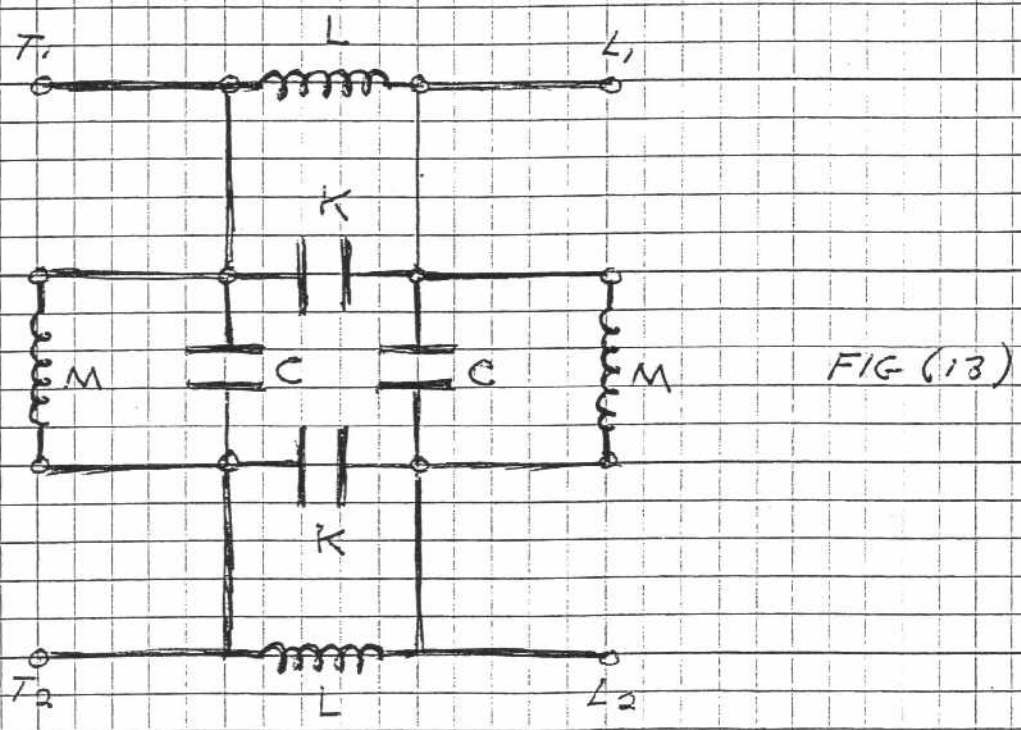
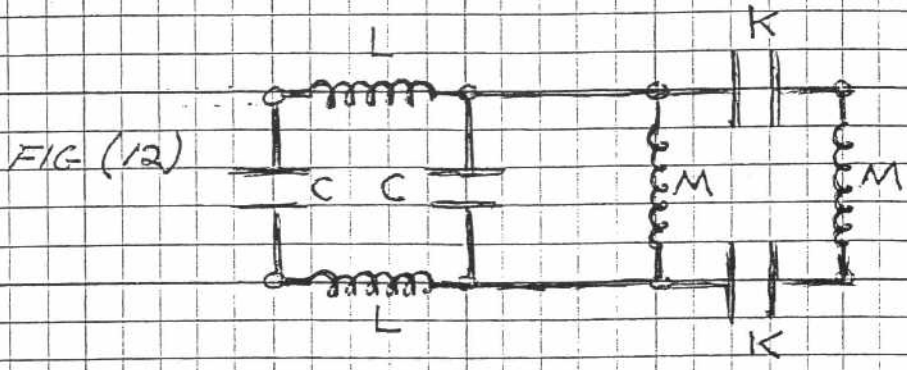

HOWEVER, FUNDS FOR THIS PROJECT HAVE EXPIRED, THEREFORE THIS PAPER ENDS AT THIS POINT.....

## TENTATIVE

LET THE PROPAGATION OF THE LONGITUDINAL COMPONENT OF THE ELECTRIC WAVE BE REPRESENTED BY THE RELATIONS

THE PROPAGATION ADMITTANCE

$$Y_c = \sqrt{\frac{M}{K}} \quad \text{FARAD PER SEC (PER OHM)}$$

THE PROPAGATION COUNTER-VELOCITY

$$U_c = \sqrt{MK} \quad \text{PER UNIT LENGTH PER SEC.}$$

THE PROPAGATION CONSTANT

$$\alpha = \omega / \sqrt{MK} \quad \text{RADIAN \cdot UNIT LENGTH}$$

HENCE, THE PROPAGATION OF THE LONGITUDINAL WAVE IS GIVEN BY

$$E_1 = E_0 \cos \alpha s + j I_0 / Y_c \sin \alpha s$$

$$I_1 = I_0 \cos \alpha s - j E_0 Y_c \sin \alpha s$$

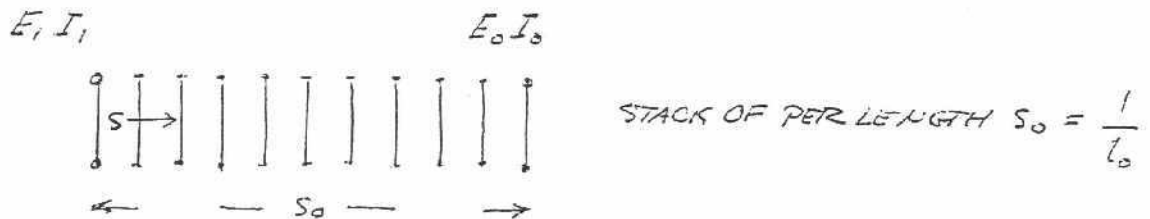

AND

$$E_1 I_1 = E_0 I_0$$

$$\alpha = \frac{\pi}{2} s_1 \quad s_1 = \frac{4}{\lambda}$$



## TENTATIVE

LET THE PROPAGATION OF THE TRANSVERSE COMPONENT OF THE ELECTRIC WAVE BE REPRESENTED BY THE RELATION

THE PROPAGATION IMPEDANCE

$$Z_0 = \sqrt{L/C} \quad \text{HENRY PER SEC. (OHM)}$$

THE PROPAGATION VELOCITY,

$$V_c = 1/\sqrt{LC} \quad \text{UNITS OF LENGTH PER SEC}$$

AND THE PROPAGATION CONSTANT

$$\beta = \omega\sqrt{LC} = 2\pi F\sqrt{LC} \quad \text{RADIAN'S PER UNIT LEN}$$

HENCE, THE PROPAGATION OF THE TRANSVERSE WAVE IS GIVEN BY

$$E_l = E_0 \cos \beta l + j I_0 Z_0 \sin \beta l \quad \text{VOLT}$$

$$I_l = I_0 \cos \beta l + j E_0 / Z_0 \sin \beta l \quad \text{AMPERE}$$

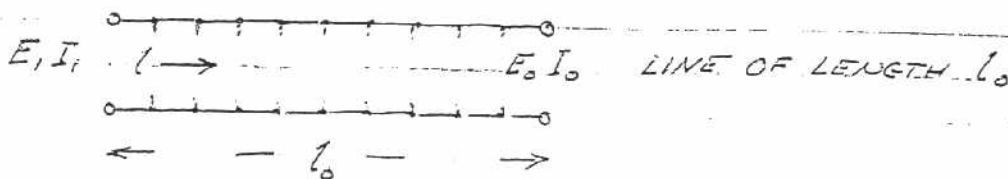

AND

$$E_l I_l = E_0 I_0 \quad \text{VOLT-AMPERE}$$

$$\beta = \frac{\pi}{2} \frac{1}{l_1}, \quad l_1 = \lambda/4$$

# Appendix III

## Historic Patents

Nikola Tesla . . . . .	US Patent #1,119,731 . . .	Page 341
Guglielmo Marconi . . . . .	US Patent #586,193 . . .	Page 346
Ernst Alexanderson . . . . .	US Patent #1,360,167 . . .	Page 358
Raymond Heising . . . . .	US Patent #1,562,961 . . .	Page 370



# Nikola Tesla



First Generation Electrostatic Wireless  
US Patent #1,119,732  
Demonstrated Experimentally, but Unrealized Commercially  
(Colorado Springs Experiments and Basis of Wardencllyffe)

N. TESLA.

APPARATUS FOR TRANSMITTING ELECTRICAL ENERGY.  
APPLICATION FILED JAN. 16, 1903. RENEWED MAY 4, 1907.

1,119,732.

Patented Dec. 1, 1914.

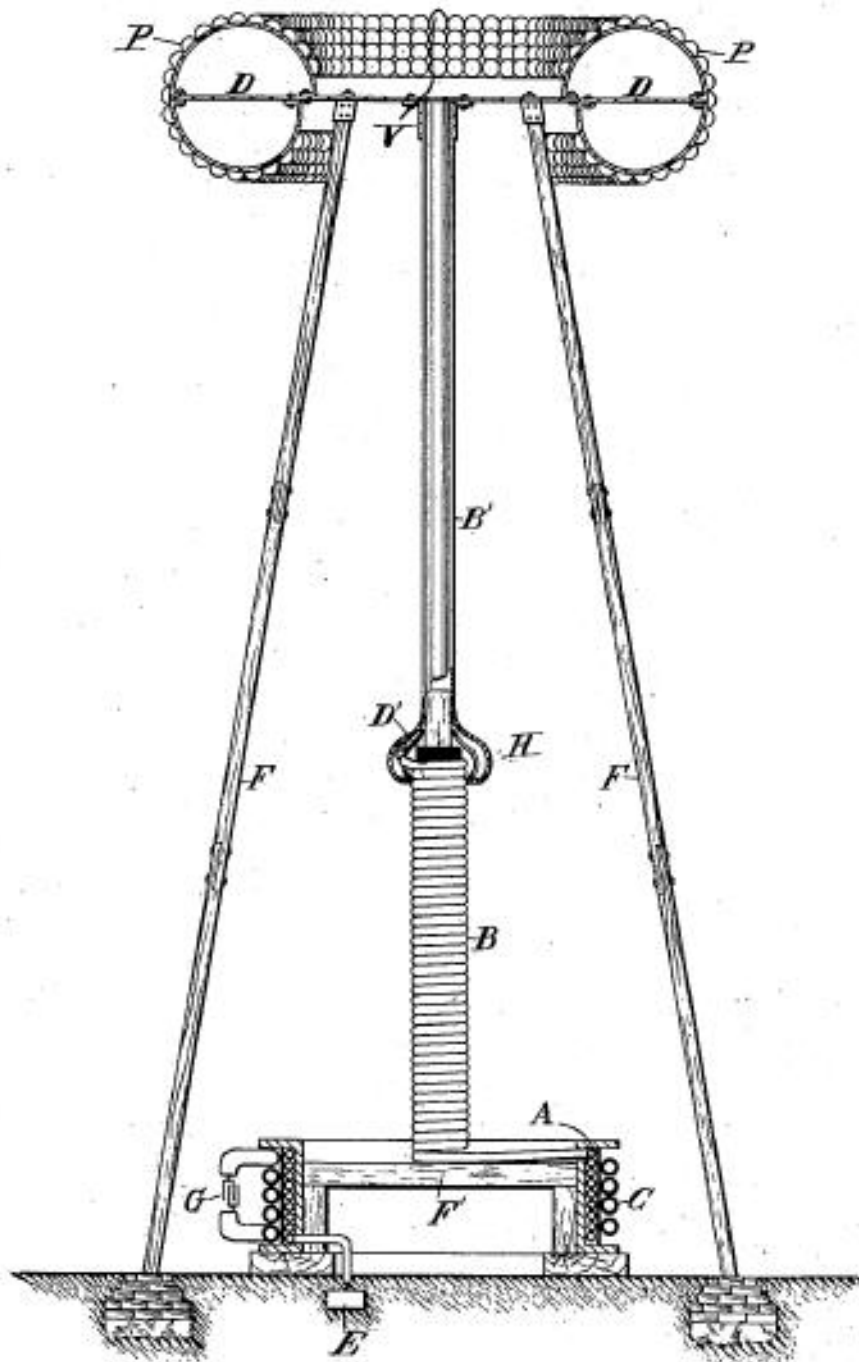

WITNESSES:

*M. Lawson Gyer*  
*Benjamin Miller.*

*Nikola Tesla,* INVENTOR,  
BY *Kerr, Page & Cooper,*  
*his* ATTORNEYS.



# UNITED STATES PATENT OFFICE.

NIKOLA TESLA, OF NEW YORK, N. Y.

## APPARATUS FOR TRANSMITTING ELECTRICAL ENERGY.

1,119,732.

Specification of Letters Patent.

Patented Dec. 1, 1914.

Application filed January 18, 1902, Serial No. 90,245. Renewed May 4, 1907. Serial No. 371,817.

*To all whom it may concern:*

Be it known that I, NIKOLA TESLA, a citizen of the United States, residing in the borough of Manhattan, in the city, county, and State of New York, have invented certain new and useful Improvements in Apparatus for Transmitting Electrical Energy, of which the following is a specification, reference being had to the drawing accompanying and forming a part of the same.

In endeavoring to adapt currents or discharges of very high tension to various valuable uses, as the distribution of energy through wires from central plants to distant places of consumption, or the transmission of powerful disturbances to great distances, through the natural or non-artificial media, I have encountered difficulties in confining considerable amounts of electricity to the conductors and preventing its leakage over their supports, or its escape into the ambient air, which always takes place when the electric surface density reaches a certain value.

The intensity of the effect of a transmitting circuit with a free or elevated terminal is proportionate to the quantity of electricity displaced, which is determined by the product of the capacity of the circuit, the pressure, and the frequency of the currents employed. To produce an electrical movement of the required magnitude it is desirable to charge the terminal as highly as possible, for while a great quantity of electricity may also be displaced by a large capacity charged to low pressure, there are disadvantages met with in many cases when the former is made too large. The chief of these are due to the fact that an increase of the capacity entails a lowering of the frequency of the impulses or discharges and a diminution of the energy of vibration. This will be understood when it is borne in mind, that a circuit with a large capacity behaves as a slackspring, whereas one with a small capacity acts like a stiff spring, vibrating more vigorously. Therefore, in order to attain the highest possible frequency, which for certain purposes is advantageous and, apart from that, to develop the greatest energy in such a transmitting circuit, I employ a terminal of relatively small capacity, which I charge to as high a pressure as practicable. To accomplish this result I have found it imperative to so construct the elevated conductor, that its outer surface, on

which the electrical charge chiefly accumulates, has itself a large radius of curvature, or is composed of separate elements which, irrespective of their own radius of curvature, are arranged in close proximity to each other and so, that the outside ideal surface enveloping them is of a large radius. Evidently, the smaller the radius of curvature the greater, for a given electric displacement, will be the surface-density and, consequently, the lower the limiting pressure to which the terminal may be charged without electricity escaping into the air. Such a terminal I secure to an insulating support entering more or less into its interior, and I likewise connect the circuit to it inside or, generally, at points where the electric density is small. This plan of constructing and supporting a highly charged conductor I have found to be of great practical importance, and it may be usefully applied in many ways.

Referring to the accompanying drawing, the figure is a view in elevation and part section of an improved free terminal and circuit of large surface with supporting structure and generating apparatus.

The terminal D consists of a suitably shaped metallic frame, in this case a ring of nearly circular cross section, which is covered with half spherical metal plates P P, thus constituting a very large conducting surface, smooth on all places where the electric charge principally accumulates. The frame is carried by a strong platform expressly provided for safety appliances, instruments of observation, etc., which in turn rests on insulating supports F F. These should penetrate far into the hollow space formed by the terminal, and if the electric density at the points where they are bolted to the frame is still considerable, they may be specially protected by conducting hoods as H.

A part of the improvements which form the subject of this specification, the transmitting circuit, in its general features, is identical with that described and claimed in my original Patents Nos. 645,576 and 649,621. The circuit comprises a coil A which is in close inductive relation with a primary C, and one end of which is connected to a ground-plate E, while its other end is led through a separate self-induction coil B and a metallic cylinder B' to the terminal D.



The connection to the latter should always be made at, or near the center, in order to secure a symmetrical distribution of the current, as otherwise, when the frequency is very high and the flow of large volume, the performance of the apparatus might be impaired. The primary C may be excited in any desired manner, from a suitable source of currents G, which may be an alternator or condenser, the important requirement being that the resonant condition is established, that is to say, that the terminal D is charged to the maximum pressure developed in the circuit, as I have specified in my original patents before referred to. The adjustments should be made with particular care when the transmitter is one of great power, not only on account of economy, but also in order to avoid danger. I have shown that it is practicable to produce in a resonating circuit as E A B B' D immense electrical activities, measured by tens and even hundreds of thousands of horse-power, and in such a case, if the points of maximum pressure should be shifted below the terminal D, along coil B, a ball of fire might break out and destroy the support F or anything else in the way. For the better appreciation of the nature of this danger it should be stated, that the destructive action may take place with inconceivable violence. This will cease to be surprising when it is borne in mind, that the entire energy accumulated in the excited circuit, instead of requiring, as under normal working conditions, one quarter of the period or more for its transformation from static to kinetic form, may spend itself in an incomparably smaller interval of time, at a rate of many millions of horse power. The accident is apt to occur when, the transmitting circuit being strongly excited, the impressed oscillations upon it are caused, in any manner more or less sudden, to be more rapid than the free oscillations. It is therefore advisable to begin the adjustments with feeble and somewhat slower impressed oscillations, strengthening and quickening them gradually, until the apparatus has been brought under perfect control. To increase the safety, I provide on a convenient place, preferably on terminal D, one or more elements or plates either of somewhat smaller radius of curvature or protruding more or less beyond the others (in which case they may be of larger radius of curvature) so that, should the pressure rise to a value, beyond which it is not desired to go, the powerful discharge may dart out there and lose itself harmlessly in the air. Such a plate, performing a function similar to that of a safety valve on a high pressure reservoir, is indicated at V.

Still further extending the principles underlying my invention, special reference is made to coil B and conductor B'. The

latter is in the form of a cylinder with smooth or polished surface of a radius much larger than that of the half spherical elements P P, and widens out at the bottom into a hood H, which should be slotted to avoid loss by eddy currents and the purpose of which will be clear from the foregoing. The coil B is wound on a frame or drum D' of insulating material, with its turns close together. I have discovered that when so wound the effect of the small radius of curvature of the wire itself is overcome and the coil behaves as a conductor of large radius of curvature, corresponding to that of the drum. This feature is of considerable practical importance and is applicable not only in this special instance, but generally. For example, such plates at P P of terminal D, though preferably of large radius of curvature, need not be necessarily so, for provided only that the individual plates or elements of a high potential conductor or terminal are arranged in proximity to each other and with their outer boundaries along an ideal symmetrical enveloping surface of a large radius of curvature, the advantages of the invention will be more or less fully realized. The lower end of the coil B—which, if desired, may be extended up to the terminal D—should be somewhat below the uppermost turn of coil A. This, I find, lessens the tendency of the charge to break out from the wire connecting both and to pass along the support F'.

Having described my invention, I claim:

1. As a means for producing great electrical activities a resonant circuit having its outer conducting boundaries, which are charged to a high potential, arranged in surfaces of large radii of curvature so as to prevent leakage of the oscillating charge, substantially as set forth.

2. In apparatus for the transmission of electrical energy a circuit connected to ground and to an elevated terminal and having its outer conducting boundaries, which are subject to high tension, arranged in surfaces of large radii of curvature substantially as, and for the purpose described.

3. In a plant for the transmission of electrical energy without wires, in combination with a primary or exciting circuit a secondary connected to ground and to an elevated terminal and having its outer conducting boundaries, which are charged to a high potential, arranged in surfaces of large radii of curvature for the purpose of preventing leakage and loss of energy, substantially as set forth.

4. As a means for transmitting electrical energy to a distance through the natural media a grounded resonant circuit, comprising a part upon which oscillations are impressed and another for raising the ten-



sion, having its outer conducting boundaries on which a high tension charge accumulates arranged in surfaces of large radii of curvature, substantially as described.

5 5. The means for producing excessive electric potentials consisting of a primary exciting circuit and a resonant secondary having its outer conducting elements which are subject to high tension arranged in proximity to each other and in surfaces of large radii of curvature so as to prevent leakage of the charge and attendant lowering of potential, substantially as described.

10 6. A circuit comprising a part upon which oscillations are impressed and another part for raising the tension by resonance, the latter part being supported on places of low electric density and having its outermost conducting boundaries arranged in surfaces of large radii of curvature, as set forth.

15 7. In apparatus for the transmission of electrical energy without wires a grounded circuit the outer conducting elements of which have a great aggregate area and are arranged in surfaces of large radii of curvature so as to permit the storing of a high charge at a small electric density and prevent loss through leakage, substantially as described.

8. A wireless transmitter comprising in combination a source of oscillations as a condenser, a primary exciting circuit and a secondary grounded and elevated conductor the outer conducting boundaries of which are in proximity to each other and arranged in surfaces of large radii of curvature, substantially as described.

9. In apparatus for the transmission of electrical energy without wires an elevated conductor or antenna having its outer high potential conducting or capacity elements arranged in proximity to each other and in surfaces of large radii of curvature so as to overcome the effect of the small radius of curvature of the individual elements and leakage of the charge, as set forth.

10. A grounded resonant transmitting circuit having its outer conducting boundaries arranged in surfaces of large radii of curvature in combination with an elevated terminal of great surface supported at points of low electric density, substantially as described.

NIKOLA TESLA.

Witnesses:

M. LAMSON DYER,  
RICHARD DONOVAN.

# Guglielmo Marconi



Second Generation Electrostatic Wireless  
US Patent #586,193  
Starting Place for First Commercial Development  
(First System at Bolinas)



G. MARCONI.  
TRANSMITTING ELECTRICAL SIGNALS

No. 586,193.

Patented July 13, 1897.

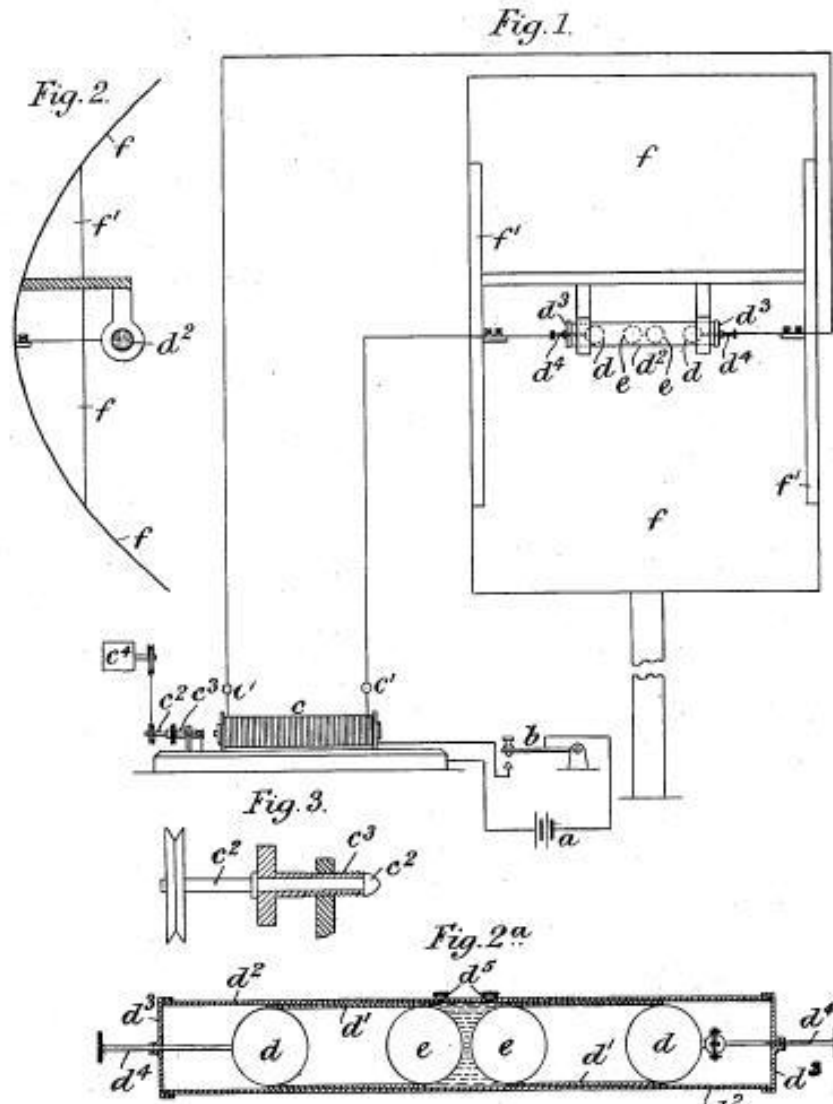

Witnesses  
*E. A. Balloch*  
*B. W. Miller*

*Giuglielmo Marconi,*  
 Inventor  
 By his Attorneys,  
*Baldwin, Davidson & Wright*

G. MARCONI.  
TRANSMITTING ELECTRICAL SIGNALS.

No. 586,193.

Patented July 13, 1897.

Fig. 4.

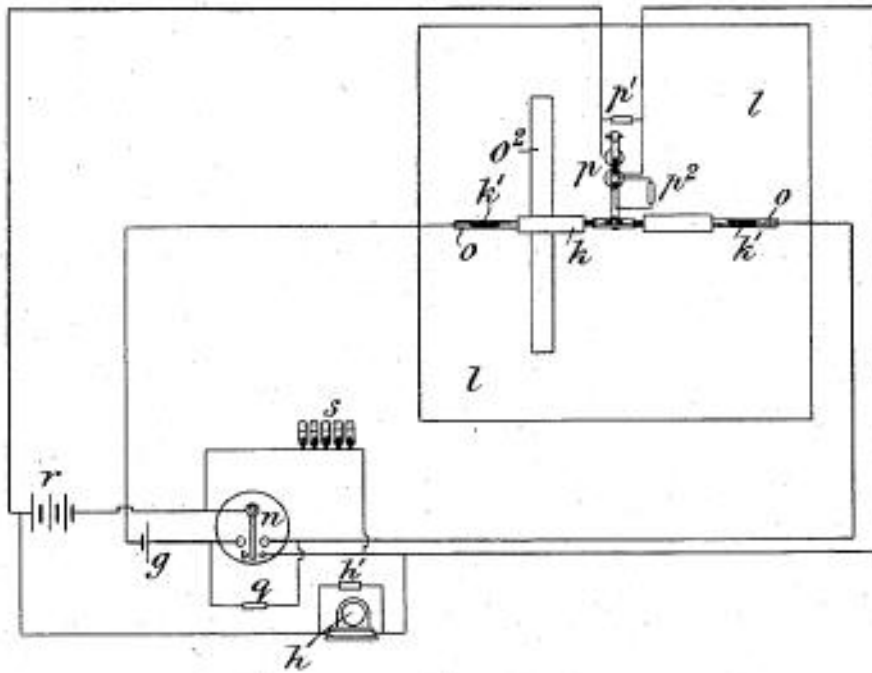

Fig. 5.



Fig. 6.

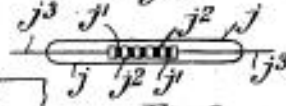

Fig. 7.

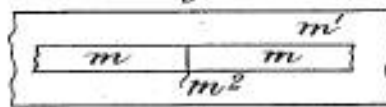

Fig. 8.



Witnesses  
E. A. Balloch  
B. W. Miller

Giuglielmo Marconi,  
Inventor  
By his Attorneys  
Reddon, Davidson & Night



G. MARCONI.  
TRANSMITTING ELECTRICAL SIGNALS.

No. 586,193.

Patented July 13, 1897.

Fig. 9.

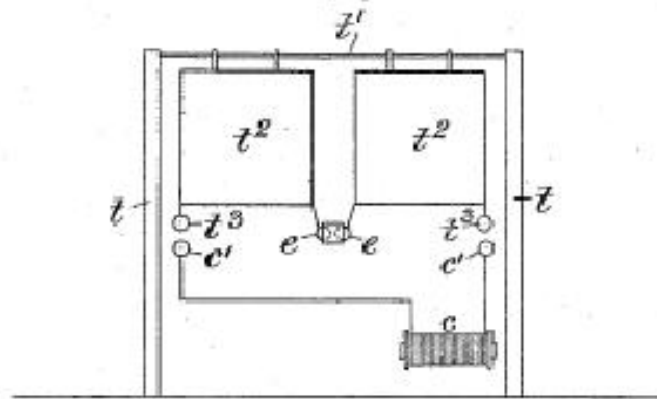

Fig. 10.

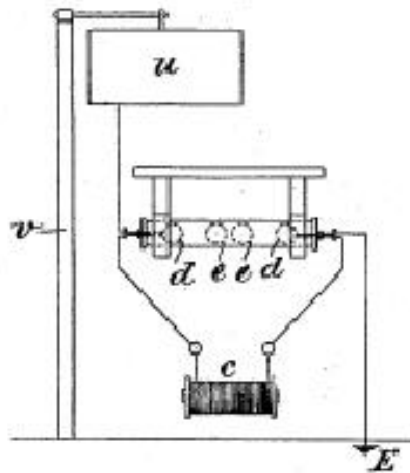
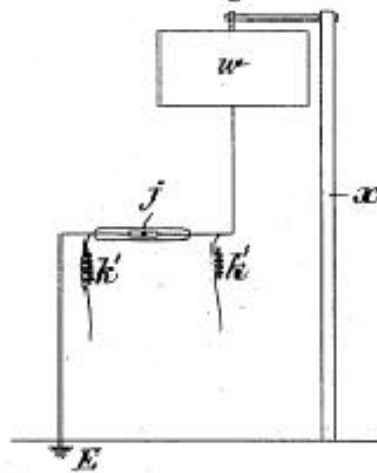

Fig. 11.



Witnesses

E. A. Bullock  
B. W. Miller

Giuseppe Marconi  
Inventor

By his Attorneys  
Baldwin, Davidson & Knight

# UNITED STATES PATENT OFFICE.

GUGLIELMO MARCONI, OF LONDON, ENGLAND.

## TRANSMITTING ELECTRICAL SIGNALS.

SPECIFICATION forming part of Letters Patent No. 586,193, dated July 13, 1897.

Application filed December 7, 1895. Serial No. 614,838. (No model.)

*To all whom it may concern:*

Be it known that I, GUGLIELMO MARCONI, student, a subject of the King of Italy, residing at 21 Burlington Road, London, in the county of Middlesex, England, have invented certain new and useful Improvements in Transmitting Electrical Impulses and Signals and in Apparatus Therefor, of which the following is a specification.

According to this invention electrical signals, actions, or manifestations are transmitted through the air, earth, or water by means of oscillations of high frequency, such as have been called the "Hertz rays" or "Hertz oscillations." Usually all line-wires are dispensed with. At the transmitting-station I employ a Ruhmkorff coil, having in its primary circuit a Morse key or other signaling instrument and at its poles appliances for producing the desired oscillations. The Ruhmkorff coil may, however, be replaced by any other source of high-tension electricity. When working with large amounts of energy, it is, however, better to keep the coil or transformer constantly working for the time during which one is transmitting, and instead of interrupting the current of the primary interrupting the discharge of the secondary. In this case the contacts of the key should be immersed in oil, as otherwise, owing to the length of the spark, the current will continue to pass after the contacts have been separated. At the receiving-station there is a local-battery circuit, containing any ordinary receiving instrument and an appliance for closing the circuit, the latter being actuated by the oscillations from the transmitting-station. When transmitting through the air and it is desired that the signal should only be sent in one direction, I place the oscillation-producer at the transmitting-station in the focus or focal line of a reflector directed to the receiving-station, and I place the circuit-closer at the receiving-station in a similar reflector directed toward the transmitting-station. When transmitting signals through the earth, I connect one end of the oscillation-producer and one end of the circuit-closer to earth and the other ends to similar plates, preferably electrically tuned with each other in the air and insulated from earth.

Figure 1 is a diagrammatic front elevation

of the instruments at the transmitting-station when signaling through the air, and Fig. 2 is a vertical section of the transmitter. Fig. 2<sup>a</sup> is a longitudinal section of the oscillator to a larger scale. Fig. 3 shows a detail on a larger scale. Fig. 4 is a diagrammatic front elevation of the instruments at the receiving-station. Fig. 5 is a full-sized view of the receiver. Fig. 6 shows a modification of the tube *j*. Fig. 7 shows the detector. Fig. 8 is a full-sized view of the liquid-resistance. Figs. 9 and 10 show modifications of the arrangements at the transmitting-station. Fig. 11 shows a modification of the arrangements at the receiving-station.

Referring now to Fig. 1, *a* is a battery, and *b* an ordinary Morse key closing the circuit through the primary of a Ruhmkorff coil *c*. The terminals *c'* of the secondary circuit of the coil are connected to two metallic balls *d d*, fixed by heat or otherwise at the ends of tubes *d' d'*, Fig. 2<sup>a</sup>, of insulating material, such as ebonite or vulcanite. *e e* are similar balls fixed in the other ends of the tubes *d'*. The tubes *d'* fit tightly in a similar tube *d<sup>2</sup>*, having covers *d<sup>2</sup>*, through which pass rods *d<sup>1</sup>*, connecting the balls *d* to the conductors. One (or both) of the rods *d<sup>1</sup>* is connected to the ball *d* by a ball-and-socket joint and has a screw-thread upon it working in a nut in the cover *d<sup>2</sup>*. By turning the rod therefore the distance of the balls *e* apart can be adjusted. *d<sup>2</sup>* are holes in the tube *d<sup>2</sup>*, through which vase-line, oil, or like material is introduced into the space between the balls *e*.

The balls *d* and *e* are preferably of solid brass or copper, and the distance they should be apart depends on the quantity and electromotive force of the electricity employed, the effect increasing with the distance so long as the discharge passes freely. With a coil giving an ordinary eight-inch spark the distance between *e* and *e* should be from one twenty-fifth to one-thirtieth of an inch and the distance between *d* and *e* about one and a half inches. *f* is a cylindrical parabolic reflector made by bending a metallic sheet, preferably of brass or copper, to form and fixing it to metallic or wooden ribs *f'*. Other conditions being equal the larger the balls the greater is the distance at which it is possible to communicate. I have generally used



balls of solid brass of four inches diameter, giving oscillations of ten inches length of wave.

The reflectors applied to the receiver and transmitter ought to be preferably in length and opening the double at least of the length of wave emitted from the oscillator.

If a very powerful source of electricity giving a very long spark be employed, it is preferable to divide the spark gap between the central balls of the oscillator into several smaller gaps in series. This may be done by introducing between the big balls smaller ones, (of about half an inch diameter,) held in position by ebonite frames.

I find that the regularity and power of the discharge of an ordinary Ruhmkorff coil with a trembler-break on its primary is greatly improved by causing one of the contacts of the vibrating break to revolve rapidly. I do this by having a revoluble central core  $c^2$ , Fig. 3, in the ordinary screw  $c^1$ , which is in communication with the platinum contacts. I cause the said central core with one of the platinum contacts attached to it to revolve by connecting it to a small electric motor  $c^4$ . This motor can be worked by the same circuit that works the coil, or, if necessary, by a separate circuit. The connections are not shown in the drawings. By this means the platinum is kept smooth and any tendency to stick is removed. They last also much longer. At the receiving-station is a battery whose circuit includes an ordinary telegraphic instrument (or it may be a relay or other apparatus which it is desired to work from a distance) and a circuit-closer.

In Fig. 4,  $g$  is the battery, and  $h$  a telegraphic instrument on the derived circuit of a relay  $n$ .

The appliance I employ as a circuit-closer is shown full size at Fig. 5 and consists of a glass tube  $j$ , containing metallic powder or grains of metal  $j^1$ , each end of the column of powder being connected to a metallic plate  $k$  of suitable length to cause the system to resonate electrically in unison with the electrical oscillations transmitted. The glass tube may be replaced in some cases by one of gutta-percha or like material. Two short pieces of thick silver wire  $j^2$  of the same diameter as the internal diameter of the tube  $j$ , so as to fit tightly in it, are joined to two pieces of platinum wire  $j^3$ . The tube is closed and sealed onto the platinum wires  $j^3$  at both ends.

Many metals can be employed for producing the powder or filings  $j^1$ ; but I prefer to use a mixture of two or more different metals. I find hard nickel to be the best metal, and I prefer to add to the nickel filings about ten percent. of hard-silver filings, which increase greatly the sensitiveness of the tube to electric oscillations. By increasing the proportion of silver powder or grains the sensitiveness of the tube also increases; but it is better for ordinary work not to have a tube of too great sensitiveness, as it might be influ-

enced by atmospheric or other electricity. The sensitiveness can also be increased by adding a very small amount of mercury to the filings and mixing up until the mercury is absorbed.

The mercury must not be in such a quantity as to clot or cake the filings. An almost imperceptible globule is sufficient for a tube. Instead of mixing the mercury with the powder one can obtain the same effects by slightly amalgamating the inner surfaces of the plugs which are to be in contact with the filings. Very little mercury must be used, just sufficient to brighten the surface of the metallic plugs without showing any free globules. The size of the tube and the distance between the two metallic stops may vary under certain limits. The greater the space allowed for the powder the larger and coarser ought to be the filings or grains.

I prefer to make my sensitive tubes of the following size: The tube  $j$  is one and one-half inches long and one-tenth or one-twelfth of an inch internal diameter. The length of the stops  $j^2$  is about one-fifth of an inch, and the distance between the stops is about one-thirtieth of an inch. I find that the smaller the space between the stops in the tube the more sensitive it proves, but the space cannot under ordinary circumstances be excessively shortened without injuring the fidelity of the transmission.

The metallic powders ought not to be fine, but rather as coarse as can be produced by a large and rough file.

All the very fine powder ought to be removed by blowing or sifting.

The powder ought not to be compressed between the stops, but rather loose and in such a condition that when the tube is tapped the powder may be seen to move.

The tube must be sealed, but a vacuum inside it is not essential, except the slight vacuum which results from having heated it while sealing it. Care must also be taken not to heat the tube too much in the center when sealing it, as it would oxidize the surfaces of the silver stops and also the powder, which would diminish its sensitiveness. I use in sealing the tubes a hydrogen and air flame. A vacuum is, however, desirable, and I have used one of about one one-thousandth of an atmosphere, obtained by a mercury-pump. It is also necessary for the powder or grains to be dry and free from grease or dirt, and the files used in producing the same ought to be frequently washed and dried and used when warm.

If the tube has been well made, it should be sensitive to the induction of an ordinary electric bell when the same is working at one to two yards or more from the tube.

In order to keep the sensitive tube  $j$  in good working order, it is desirable, but not absolutely necessary, not to allow more than one milliamperé to flow through it when active. If a stronger current is necessary, several tubes may be put in derivation between the



tuned plates, but this arrangement is not quite as satisfactory as the single tube. It is necessary when using tubes of the type I have described not to insert in the circuit more than one cell of the Leclanché type, as a higher electromotive force than 1.5 volts is apt to pass a current through the tube even when no oscillations are transmitted. I can, however, construct tubes capable of working with a much higher electromotive force. Fig. 6 shows one of these tubes. In this tube instead of one space or gap filled with filings there are several spaces separated by sections of tight-fitting silver wire. A tube thus constructed, observing also the rules of construction of my tubes in general, will work satisfactorily if the electromotive force of the battery in circuit with the tube is equal to 1.2 volts multiplied by the number of gaps. With this tube also it is well not to allow a current of more than one milliamperere to pass.

The tube *j* may be replaced by other forms of imperfect electrical contacts, but this is not desirable.

The plates *k* are of copper or aluminium or other metal, about half an inch or more broad, about one-fiftieth of an inch thick, and preferably of such a length as to be electrically tuned with the electric oscillations transmitted. The means I adopt for fixing the length of the plates is as follows: I stick a rectangular strip of tin-foil *m* (see Fig. 7) about twenty inches long (the length depends on the supposed length of wave that one is measuring) by means of a weak solution of gum onto a glass plate *m'*. Then by means of a very sharp penknife or point I cut across the middle of the tin-foil, leaving a mark of division *m<sup>2</sup>*. If this detector is held in the proximity (four or five yards) and parallel with the axis of the oscillator in action, it will show little sparks at *m<sup>2</sup>*. If the length of the pieces of tin-foil approximates to the length of wave emitted from the oscillator, the spark will take place between them at a certain distance from the transmitter, which is a maximum when they are of suitable length. By shortening or lengthening the strips, therefore, it is easy to find the length most appropriate to the length of wave emitted by the oscillator. It is desirable to try this detector in the focus or focal line of the reflector. The length so found is the proper length for the plates *k*, or rather these should be about half an inch shorter on account of the length of the sensitive tube *j*, connected between them.

*l* is a cylindrical parabolic reflector similar to that used at the transmitting-station.

The plates *k* may be in the form of tubes or even wires.

It is slightly advantageous for the focal distance of the reflector to be equal to one-fourth or three-fourths of the wave length of the oscillation transmitted.

When no oscillations are sent from the transmitting-station, the tube *j* does not conduct the current, and the local-battery circuit

is broken, but when the powder or tube is influenced by the electrical oscillations from the transmitter it conducts and closes the circuit. I find, however, that when once started the powder in the tube continues to conduct even when the oscillations from the transmitter have ceased, but if it be shaken or tapped the circuit is broken. A tube well prepared will instantly interrupt the current passing through it at the slightest tap, provided it is inserted in a circuit in which there is little self-induction and small electromotive force, such as a single cell, and where the effects of self-induction have been removed by one of the methods which I will presently describe.

The two plates *k* communicate with the local circuit through two very small coils *k'*, which I will call "choking-coils," formed by winding a few inches of very thin and insulated copper wire around a bit of iron wire about an inch and a half long. The object of these choking-coils is to prevent the high-frequency oscillation induced across these plates by the transmitter from dissipating itself by running along the local-battery wires which might weaken its effect on the sensitive tube *j*. These choking-coils may, however, be sometimes replaced by simple thin wires. They may also be connected directly to the tube *j*. The local circuit in which the sensitive tube *j* is inserted contains a sensitive relay *n*, preferably wound to a resistance of about twelve hundred ohms. This resistance need not be necessarily that of the relay, but may be the sum of the resistance of the relay and another additional resistance. The relay ought to be one possessing small self-induction.

The plates *k*, tube *j*, and coils *k'* are fastened by means of wire stitches *o'* to a thin glass tube *o*, preferably not longer than twelve inches, firmly fixed at one end to a strong piece of timber *o<sup>2</sup>*. This may be done by means of wood or ebonite grasping-screws.

I do the tapping automatically by the current started by the tube, employing a trembler *p* on the circuit of the relay *n* similar in construction to that of an electric bell, but having a shorter arm. The vibrator must be carefully adjusted. Preferably the blows should be directed slightly upward to prevent the filings from getting caked. In place of tapping the tube the powder can be disturbed by slightly moving outward and inward one or both of the stops *j<sup>2</sup>*, the trembler *p* being replaced by a small electromagnet (or magnets) whose armature is connected to the stop.

I ordinarily work the telegraphic receiver *k* (or other instruments) by a derivation, as shown, from the circuit which works the trembler *p*. They can also, however, be worked in series with the trembler. When working ordinary sounders or Morse apparatus, a special adjustment of the same is sometimes needed to enable one to obtain dots and dashes. Sometimes it is necessary to work the telegraphic instruments or relays from the back-stops of the first relay, as is done in



some systems of multiple telegraphy. Such adjustments are known to telegraphic experts.

By means of a tube with multiple gaps it is possible to work the trembler and also the signaling or other apparatus direct on the circuit which contains the tube, but I prefer when possible to work with the single-gap tube and the relay, as shown. With a sensitive and well-constructed trembler it is also possible to work the trembler with the single-gap tube in series with it without the relay.

In derivation on the terminals of the relay  $n$  is placed an ordinary platinoid resistance double-wound (or wound on the "bight," as it is sometimes termed) coil  $q$  of about four times the resistance of the relay, which prevents the self-induction of the winding of the relay from affecting the sensitive tube.

The circuit actuated by the relay contains an ordinary battery  $r$  of about twelve cells and the trembler  $p$ , the resistance of the winding of which should be about one thousand ohms, and the nucleus ought preferably to be of soft iron, hollow and split lengthwise, like most electromagnets used in telegraph instruments. In series or derivation from this circuit is inserted the telegraphic or other apparatus  $h$  which one may desire to work. It is desirable that this instrument or apparatus, if on a derivation, should have a resistance equal to the resistance of the trembler  $p$ . A platinoid resistance  $h'$  of about five times the resistance of the instrument is inserted in derivation across the terminals of the instrument and connected as close to the same as possible. In derivation across the terminals of the trembler  $p$  is placed another platinoid resistance  $p'$ , also of about five times the resistance of the trembler. A similar resistance  $p''$  is inserted in a circuit connecting the vibrating contacts of the trembler. In derivation across the terminals of the relay-circuit it is well to have a liquid resistance  $s$ , which is constituted of a series of tubes, one of which is shown full size in Fig. 8, filled with water-acidulated with sulfuric acid. The number of these tubes in series across the said terminals ought to be about ten for a circuit of fifteen volts, so as to prevent, in consequence of their counter electromotive force, the current of the local battery from passing through them, but allowing the high-tension jerk of current generated at the opening of the circuit in the relay to pass smoothly across them without producing perturbing sparks at the movable contact of the relay. It is also necessary to insert a platinoid resistance in derivation on any apparatus one may be working on the local circuits. These resistances ought also to be inserted in derivation on the terminals of any resistance which may be apt to give self-induction.

I have hitherto only mentioned the use of cylindrical reflectors, but it is also possible to use ordinary concave reflectors, preferably parabolic, such as are used for projectors.

It is not essential to have a reflector at the transmitters and receivers, but in their absence the distance at which one can communicate is much smaller.

I find it convenient when transmitting across long distances to make use of the transmitter shown in Fig. 9.

$t t$  are two poles connected by a rope  $t'$ , to which are suspended by means of insulating suspenders two metallic plates  $t'' t''$ , preferably in the form of cylinders closed at the top, connected to the spheres  $e$  (in oil or other dielectric, as before) and to the other balls  $f$  in proximity to the spheres  $e'$ , in communication with the coil or transformer  $c$ . The balls  $f$  are not absolutely necessary, as the plates  $t''$  may be made to communicate with the coil or transformer by means of thin insulated wires. The receiver I adopt with this transmitter is similar to it, except that the spheres  $e$  are replaced by the sensitive tube  $j$  and plates  $k$ , while the spheres  $f$  are replaced by the choking-coils  $k'$ , in communication with the local circuit. It may be observed that, other conditions being equal, the larger the plates at the transmitter and receiver and the higher they are from earth and to a certain extent the farther apart they are the greater is the distance at which correspondence is possible.

When transmitting through the earth or water, I use a transmitter as shown in Fig. 10. I connect one of the spheres  $d$  to earth  $E$ , preferably by a thick wire, and the other to a plate or conductor  $u$ , suspended on a pole  $v$  and insulated from earth; or the spheres  $d$  may be omitted and one of the spheres  $e$  be connected to earth and the other to the plate or conductor  $u$ . At the receiving-station, Fig. 11, I connect one terminal of the sensitive tube  $j$  to earth  $E$ , also by a thick wire, and the other to a plate or conductor  $w$ , preferably similar to  $u$ . The plate  $w$  may be suspended on a pole  $x$  and must be insulated from earth. The larger the plates of the receiver and transmitter and the higher from the earth the plates are suspended the greater is the distance at which it is possible to communicate. When using the last-described apparatus, it is not necessary to have the two instruments in view of each other, as it is of no consequence if they are separated by mountains or other obstacles. At the receiver it is possible to pick up the oscillations from the earth or water without having the plate  $w$ . This may be done by connecting the terminals of the sensitive tube  $j$  to two earths, preferably at a certain distance from each other and in a line with the direction from which the oscillations are coming. These connections must not be entirely conductive, but must contain a condenser of suitable capacity—say one square yard of surface. Balloons can also be used instead of plates on poles, provided they carry up a plate or are themselves made conductive by being covered with tin-foil. As the height to which they may be sent is great, the distance at which communication is possible be-



comes greatly multiplied. Kites may also be successfully employed if made conductive by means of tin-foil.

The apparatus above described is so sensitive that it is essential either that the transmitters and receivers at each station should be at a considerable distance from each other or that they should be screened from each other by stout metal plates. It is sufficient to have all the telegraphic apparatus in a metal box and any exposed part of the circuit of the receiver inclosed in metallic tubes which are in electrical communication with the box. (Of course the part of the apparatus which has to receive the radiation from the distant station must not be inclosed, but possibly screened from the local transmitter by means of metallic sheets.) When working through the earth or water, the local receiver must be switched out of circuit when the transmitter is at work, and this may also be done when working through air.

What I claim is—

1. In a receiver for electrical oscillations the combination of an imperfect electrical contact, a circuit through the contact and means actuated by the circuit for shaking the contact.

2. In a receiver for electrical oscillations the combination of an imperfect electrical contact, metallic plates connected to it, a circuit through the contact and means actuated by the circuit for shaking the contact.

3. In a receiver for electrical oscillations the combination of an imperfect electrical contact, metallic plates connected to the contact, choking-coils connected to the contact, a circuit through the coils, and contact and means actuated by the circuit for shaking the contact.

4. In a receiver for electrical oscillations the combination of a tube containing metallic powder, a circuit through the powder and means actuated by the circuit for shaking the powder.

5. In a receiver for electrical oscillations the combination of a tube containing metallic powder, metallic plates connected to the powder, a circuit through the powder and means actuated by the circuit for shaking the powder.

6. In a receiver for electrical oscillations the combination of a tube containing metallic powder, metallic plates connected to the powder, choking-coils connected to the powder, a circuit through the coils and powder and means actuated by the circuit for shaking the powder.

7. In a receiver for electrical oscillations the combination of a tube containing a mixture of metallic powders, a circuit through the powder, and means actuated by the circuit for shaking the powder.

8. In a receiver for electrical oscillations the combination of a tube containing a mixture of metallic powders, metallic plates con-

nected to the powder, a circuit through the powder and means actuated by the circuit for shaking the powder.

9. In a receiver for electrical oscillations the combination of a tube containing a mixture of metallic powders, metallic plates connected to the powder, choking-coils connected to the powder, a circuit through the coils, and powder and means actuated by the circuit for shaking the powder.

10. In a receiver for electrical oscillations the combination of a tube containing a mixture of metallic powder and mercury, a circuit through the powder and means actuated by the circuit for shaking the powder.

11. In a receiver for electrical oscillations the combination of a tube containing a mixture of metallic powder and mercury, metallic plates connected to the powder, a circuit through the powder and means actuated by the circuit for shaking the powder.

12. In a receiver for electrical oscillations the combination of a tube containing a mixture of metallic powder and mercury, metallic plates connected to the powder, choking-coils connected to the powder, a circuit through the coils and powder and means actuated by the circuit for shaking the powder.

13. In a receiver for electrical oscillations the combination of a tube, metallic plugs in the tube, metallic powder between the plugs, a circuit through the plugs and powder and means actuated by the circuit for shaking the powder.

14. In a receiver for electrical oscillations the combination of a tube, metallic plugs in the tube, metallic powder between the plugs, metallic plates connected to them, a circuit through the plugs and powder and means actuated by the circuit for shaking the powder.

15. In a receiver for electrical oscillations the combination of a tube, metallic plugs in the tube, metallic powder between the plugs, metallic plates connected to the plugs, choking-coils connected to the plugs, a circuit through the coils and plugs and means actuated by the circuit for shaking the powder.

16. In a receiver for electrical oscillations the combination of a tube, metallic plugs in the tube, a mixture of metallic powders between the plugs, a circuit through the plugs and powder and means actuated by the circuit for shaking the powder.

17. In a receiver for electrical oscillations the combination of a tube, metallic plugs in the tube, a mixture of metallic powders between the plugs, metallic plates connected to the plugs, a circuit through the plugs and powder and means actuated by the circuit for shaking the powder.

18. In a receiver for electrical oscillations the combination of a tube, metallic plugs in the tube, a mixture of metallic powders between the plugs, metallic plates connected to the plugs, choking-coils connected to the







the plugs, a circuit through the plugs and powder, a relay actuated by the circuit, and means actuated by the relay for shaking the powder.

39. In a receiver for electrical oscillations the combination of a tube, metallic plugs in the tube, a mixture of metallic powders between the plugs, metallic plates connected to the plugs, choking-coils connected to the plugs, a circuit through the coils, plugs and powder, a relay actuated by the circuit and means actuated by the relay for shaking the powder.

40. In a receiver for electrical oscillations the combination of a tube, metallic plugs in the tube, a mixture of metallic powder and mercury between the plugs, a circuit through the plugs and powder, a relay actuated by the circuit and means actuated by the relay for shaking the powder.

41. In a receiver for electrical oscillations the combination of a tube, metallic plugs in the tube, a mixture of metallic powder and mercury between the plugs, metallic plates connected to the plugs, a circuit through the plugs and powder, a relay actuated by the circuit and means actuated by the relay for shaking the powder.

42. In a receiver for electrical oscillations the combination of a tube, metallic plugs in the tube, a mixture of metallic powder and mercury between the plugs, metallic plates connected to the plugs, choking-coils connected to the plugs, a circuit through the coils, plugs and powder, a relay actuated by the circuit and means actuated by the relay for shaking the powder.

43. The combination of a spark-producer at the transmitting-station, an earth connection to one end of the spark-producer, an insulated conductor connected to the other end, an imperfect electrical contact at the receiving-station, an earth connection to one end of the contact an insulated conductor connected to the other end and a circuit through the contact.

44. The combination of a spark-producer at the transmitting-station, an earth connection to one end of the spark-producer, an insulated conductor connected to the other end, an imperfect electrical contact at the receiving-station, an earth connection to one end of the contact an insulated conductor connected to the other end, a circuit through the contact and means actuated by the circuit for shaking the contact.

45. The combination of a spark-producer at the transmitting-station, an earth connection to one end of the spark-producer, an insulated conductor connected to the other end, an imperfect electrical contact at the receiving-station, choking-coils connected to each end of the contact, an earth connection to one end of the imperfect contact an insulated conductor connected to the other end and a circuit through the coils and contact.

46. The combination of a spark-producer

at the transmitting-station, an earth connection to one end of the spark-producer, an insulated conductor connected to the other end, an imperfect electrical contact at the receiving-station, choking-coils connected to each end of the contact, an earth connection to one end of the imperfect contact, an insulated conductor connected to the other end, a circuit through the coils and contact and means actuated by the circuit for shaking the contact.

47. The combination of a spark-producer at the transmitting-station, an earth connection to one end of the spark-producer, an insulated conductor connected to the other end, a tube containing metallic powder at the receiving-station, an earth connection to one end of the powder, an insulated conductor connected to the other end and a circuit through the powder.

48. The combination of a spark-producer at the transmitting-station, an earth connection to one end of the spark-producer, an insulated conductor connected to the other end, a tube containing metallic powder at the receiving-station, an earth connection to one end of the powder an insulated conductor connected to the other end, a circuit through the powder and means actuated by the circuit for shaking the powder.

49. The combination of a spark-producer at the transmitting-station, an earth connection to one end of the spark-producer, an insulated conductor connected to the other end, a tube containing metallic powder at the receiving-station, choking-coils connected to each end of the powder, an earth connection to one end of the powder, an insulated conductor connected to the other end and a circuit through the coils and powder.

50. The combination of a spark-producer at the transmitting-station, an earth connection to one end of the spark-producer, an insulated conductor connected to the other end, a tube containing metallic powder at the receiving-station, choking-coils connected to each end of the powder, an earth connection to one end of the powder, an insulated conductor connected to the other end, a circuit through the coils and powder and means actuated by the circuit for shaking the powder.

51. The combination of a spark-producer at the transmitting-station, an earth connection to one end of the spark-producer, an insulated conductor connected to the other end, a tube containing metallic powder at the receiving-station, choking-coils and earth connection through condensers connected to each end of the powder, a circuit through the coils and powder and means actuated by the circuit for shaking the powder.

52. In a receiver for electrical oscillations, the combination of an imperfect electrical contact, a circuit through the contact, an electric trembler shaking the contact, and means for preventing the self-induction of the trembler from affecting the contact.



53. A receiver for electrical oscillatory impulses having a medium whose electrical resistance is altered by the received electrical oscillations, a trembler or shaker for acting upon the variable-resistance medium to restore it to its normal condition of electrical resistance, and means for controlling such trembler to cause it to act upon the variable-resistance medium to restore it to its normal condition after each reception of such oscillatory impulses.

54. A receiver for electrical oscillatory impulses having a medium whose electrical resistance is altered by the received electrical oscillations, a trembler or shaker for acting upon the variable-resistance medium to restore it to its normal condition of electrical resistance, means controlling such trembler to cause it to act upon the variable-resistance medium to restore it to its normal condition after each reception of such oscillatory impulses, and means for rendering manifest said electrical oscillatory impulses consecutively received, whereby defined signals may be given out by the receiver.

55. The combination of a transmitter capable of producing at will of the operator elec-

tric oscillatory impulses or rays, and a receiver responsive thereto having a variable-resistance medium whose resistance is altered by such received oscillatory impulses, means controlled by the received oscillations for restoring such medium to its normal condition after each reception of such oscillations, and means for rendering manifest the received oscillations, whereby signals sent from the transmitter may be received upon the receiver.

56. The combination of a transmitter capable of producing electrical oscillations or rays at the will of the operator, and a receiver located at a distance and having a conductor tuned to respond to such oscillations, a variable-resistance medium, in circuit with the conductor, whose resistance is altered by the received oscillations, means controlled by the received oscillations for restoring the resistance medium to its normal condition after each reception of such oscillations, and means for rendering the received oscillations manifest.

GUGLIELMO MARCONI,

Witnesses:

WILFRED CORPMAEL,  
FRED C. HARRIS.

# Ernst F. W. Alexanderson

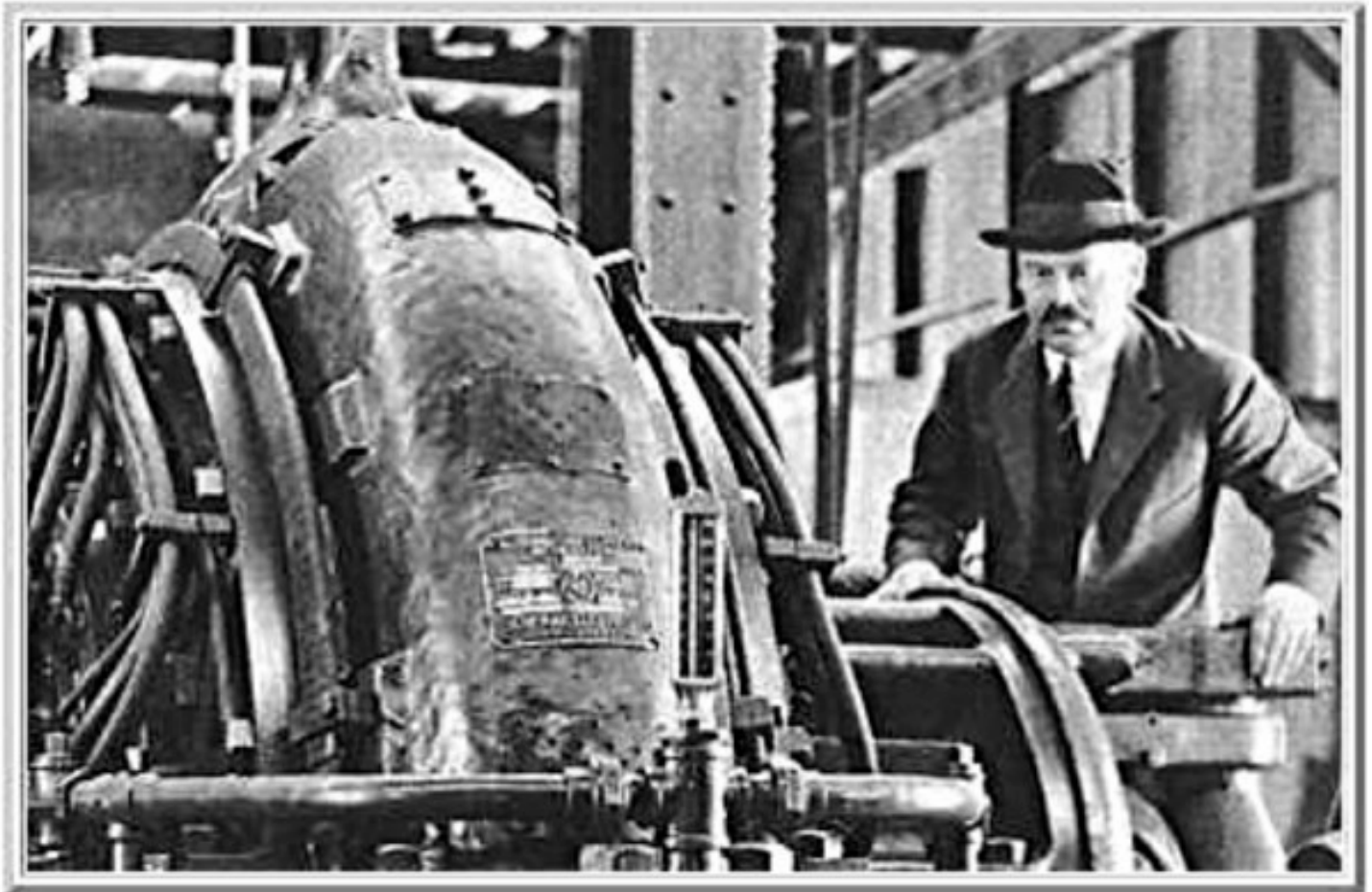

Third Generation Electrostatic Wireless  
US Patent #1,360,167  
Fully Developed and Implemented Commercially  
(Second System at Bolinas)





1,360,167.

E. F. W. ALEXANDERSON.  
ANTENNA.  
APPLICATION FILED SEPT. 13, 1917.

Patented Nov. 23, 1920.  
2 SHEETS—SHEET 2.

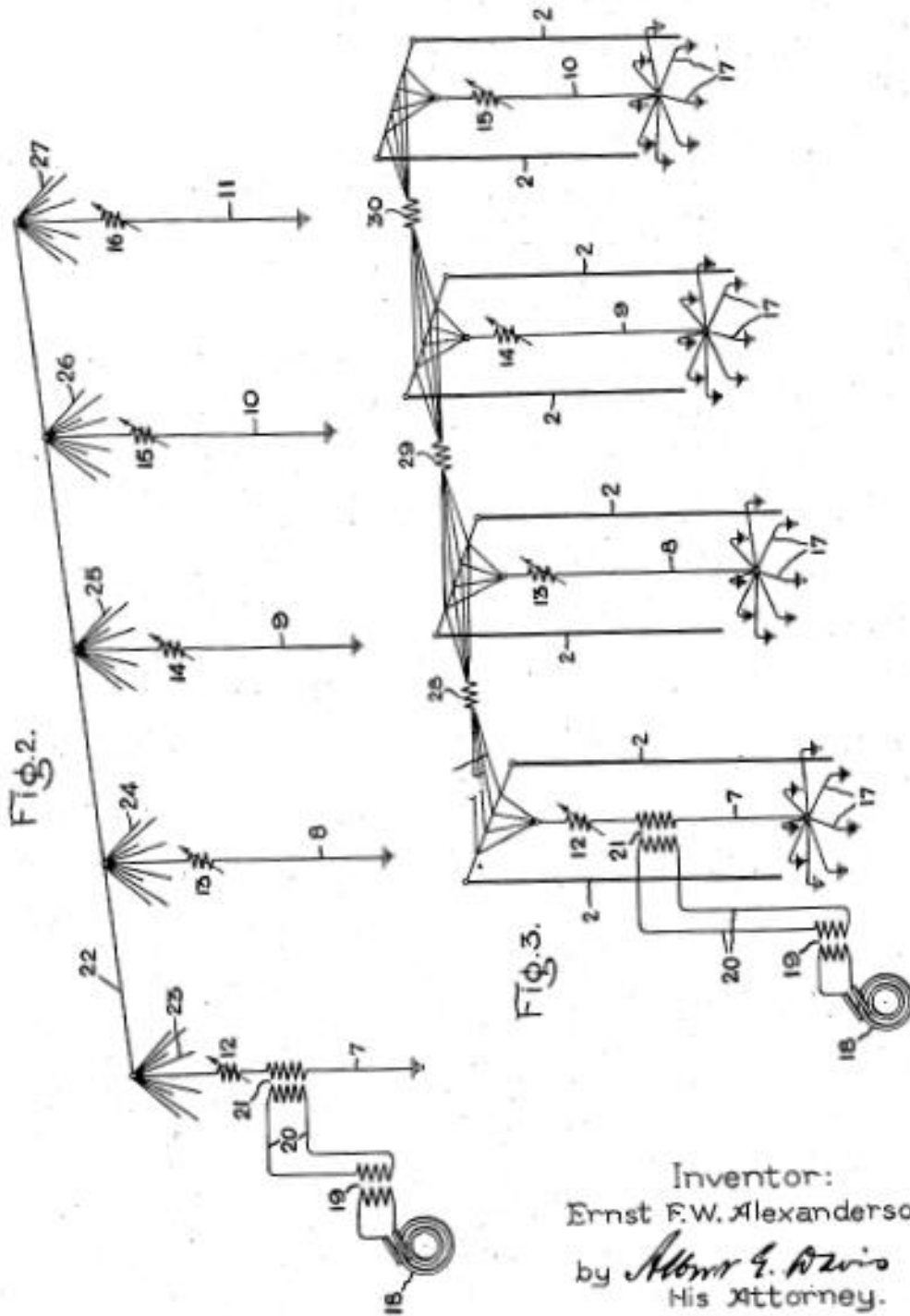

Inventor:  
Ernst F.W. Alexanderson  
by *Almon G. Davis*  
His Attorney.



# UNITED STATES PATENT OFFICE.

ERNST F. W. ALEXANDERSON, OF SCHENECTADY, NEW YORK, ASSIGNOR TO GENERAL ELECTRIC COMPANY, A CORPORATION OF NEW YORK.

## ANTENNA.

1,360,167.

Specification of Letters Patent. Patented Nov. 23, 1920.

Application filed September 13, 1917. Serial No. 191,110.

*To all whom it may concern:*

Be it known that I, ERNST F. W. ALEXANDERSON, a citizen of the United States, residing at Schenectady, in the county of Schenectady, State of New York, have invented certain new and useful Improvements in Antennae, of which the following is a specification.

My present invention relates to antennae for radio signaling systems and more particularly to the manner in which the radiation of the transmitting system is effected. My present application is a continuation in part of my prior application Serial No. 123,276 filed Oct. 2, 1916.

The antenna of a radio signaling system as previously constructed has consisted of an elevated electrical conductor or a net work of conductors which is charged by a source of high frequency energy in such a way that it becomes a source of energy radiation of the type known as the Hertzian oscillator. The theory for the radiation of an antenna has therefore been universally treated by the mathematical theory of the Hertzian oscillator.

The usual radiating antenna system may be considered as a single Hertzian oscillator. It has been proposed heretofore to employ a plurality of such oscillators in order to increase the amount of radiation or to secure directive effects but no practical use has been made of this idea because of the difficulties of controlling the phase of the oscillations in the different radiators in such a way that they would produce a combined radiation of a predetermined desired character.

One of the objects of my invention is to provide means whereby it will be possible to operate a plurality of practically separate radiators in such a way that a combined radiation of the desired character may be readily obtained.

There are several advantages which may be obtained by operating a radiating system as a plurality of separate radiators instead of as a single radiator. One of these advantages is that less energy consumption is required in order to produce a given strength of signals. This advantage may be explained briefly as follows:

In any single radiator, the strength of the electrostatic and the electromagnetic field of the radiated wave is proportional to the

current and voltage supplied to the radiator. The energy consumed by the radiator is proportional to the product of current and voltage and is consequently proportional to the square of the field intensity of the radiated wave. The general theory of wave motion, however, teaches that if several systems of waves are superimposed, they combine in such a way that the field intensity in any one place is the algebraic sum of the momentary intensities of all the separate waves. If a system consisting of a plurality of separate radiators is controlled in such a way that the relative phase of the oscillations from the individual radiators is made to combine in a predetermined desired way, it will be possible to operate the system in such a manner that the field intensity in the receiving station is the arithmetic sum of the field intensities produced by all of the individual radiators. A radiation of unity intensity from a station with a single radiator may be said to produce a field intensity of unity in the receiving station. If a system comprising a plurality of radiators is operated in such a way that each of the radiators emits a wave of unity intensity, the effect on the receiving station will be the same as that of a wave with a field strength of as many times unity as there are individual radiators.

The energy consumption of the single radiator may also be called unity and the energy consumption of each of the individual radiators of the multiple system will also be unity when operated as described. If then we assume that there are six individual radiators we will obtain with an energy consumption of six times that of the single radiator a field intensity at the receiving station which is six times as great as that obtained with a single radiator. If it were, on the other hand, desired to produce by a single radiator, a wave at the receiving station having a field strength equal to six times unity it would be necessary to increase the current as well as the voltage in the single radiator to six times unity and consequently the energy consumption of the single radiator would be 36 times unity. Thus it will be seen that the energy consumption of the single radiator will be six times as great as that of the six individual radiators in order to produce the same intensity of signals.



A second advantage of my multiple radiation system is that it renders possible the production of signals of greater intensity than it has been possible to produce heretofore regardless of the amount of energy consumed. With any antenna there is a practical limit to the amount of radiation which may be obtained, this limit being partially fixed by the maximum voltage for which it is practical to insulate the aerial. In other words, it is not possible to increase the strength of the signal above a certain value by increasing the amount of energy supplied to a single radiator, whereas with a plurality of individual radiators any increase in the signal strength desired may be obtained merely by increasing the number of radiators.

A third advantage of my system of multiple radiation is that it renders possible the production of a radiation of energy with a decided directive effect comparable with the focusing of a beam of light by a lens or a mirror. While the desirability of such an effect has frequently been mentioned and various means have been proposed for securing it none of the means heretofore proposed have been found to be applicable to practical operation.

A second object of my invention is to provide a convenient and practical means for adjusting the phase relations of the individual radiations so that the advantages of directive radiation may be realized.

In the usual type of antenna corresponding to a single Hertzian oscillator which has heretofore been used the energy is introduced through a ground lead in series with a loading coil. In an antenna of this type designed for long distance transmission assume that the current introduced through the loading coil is 100 amperes and the potential of the aerial is 50,000 volts. The energy required to maintain oscillations in such an antenna may be 50 kilowatts. This means that the energy component of the oscillating voltage is 500 volts, or as it is commonly expressed, the antenna has a resistance of 5 ohms. Thus the energy required for maintaining oscillations is delivered in the form of 100 amperes at 500 volts. While it might be possible to supply energy to each one of a plurality of radiators in this way such a method would, if the individual radiators were located at a considerable distance from each other, involve unnecessary losses due to inductive or resistance drop in the feeding wires.

A further object of my invention is to provide a system for supplying energy to the individual radiators which will overcome this disadvantage.

In attaining this object of my invention I transform the energy to the form of high potential and low current and instead of

supplying it at the ground point of the loading coil supply it at a high tension point. For example, in the case above mentioned, the energy may be supplied to the radiators at 50,000 volts and one ampere. Thus while in each case 50 kilowatts of energy is required the old form of antenna consumes this energy in the same form as if it were a resistance of five ohms whereas the radiator supplied in accordance with my invention consumes the energy in the form of a resistance of 50,000 ohms. This may be explained by reason of the fact that in the old form of antenna the energy is introduced in series with the inductance and capacity of the antenna whereas in the form of a radiator which I employ the energy is introduced to a circuit which is the equivalent of the antenna capacity in parallel with the inductance. By introducing the energy to the individual radiators in this way it is possible to feed a large number of such radiators located at a considerable distance from each other without incurring any great losses in the transmission conductors. In order to transform the energy into the desired form it might be possible to use a transformer of the ordinary type with the required ratio of transformation. I have found, however, that it is more convenient to use one of the radiating circuits as an oscillation transformer, and to supply the energy to all of the other radiators from the high tension end of the first radiator. In its preferred form then, my multiple radiating system may be considered as being made up of a primary radiator which at the same time serves as an oscillation transformer for supplying high tension energy to one or more secondary radiators. In order to have a completely balanced system of radiation, it might appear desirable to locate the primary radiator in such a way relative to the secondary radiators that the energy connections to each of the secondary radiators can be made directly to the primary radiator through wires of equal length. While this might be a practical method of construction, I have found in actual practice that it is not necessary to connect each of the secondary radiators directly to the primary radiator and that it is of practical convenience in the construction of the antenna to connect the secondary radiators successively to each other, that is so that energy current flowing from the primary radiator reaches the secondary radiators in succession. In one case in which my invention has been applied in practice the antenna has the character of a horizontal transmission line supported on towers. This antenna is divided into a plurality of individual radiators by means of ground connections with loading coils therein at suitable intervals along its length. The aerial



wires which serve as radiators also serve for transmitting energy to all of the successive radiators. Since the energy is transmitted to the secondary radiators in the form of high potential and low current it is apparent that a large number of radiators may be connected to such a transmission line without causing any appreciable changes in voltage and phase.

The novel features which I believe to be characteristic of my invention are set forth with particularity in the appended claims. My invention itself however, both as to its organization and method of operation together with further objects and advantages thereof will best be understood by reference to the following description taken in connection with the accompanying drawing in which Figures 1, 2 and 3 show diagrammatically as many different modifications and Fig. 4 is a diagram explanatory of the directive radiation feature of my invention. In the form of my invention indicated in Fig. 1 the radiating system is composed of a plurality of horizontal conductors 1 of considerable length elevated above ground by means of the supports 2 from which they are insulated. This system is divided into five individual radiators by means of the ground connections 7, 8, 9, 10, and 11, individual tuning or loading coils 12, 13, 14, 15, and 16 being included in each ground connection. The ground connections indicated consist of a plurality of wires 17 stretched over the surface of the ground, the end of each conductor being permanently earthed. The energy for signaling purposes is supplied to the first radiator of the series by a high frequency alternator 18, connected through the transformer 19 to a transmission line 20 which conveys the current to the transformer 21 by means of which it is introduced into ground connection 7.

The first radiator comprises the ground connection 7 and the portions of the conductors 1 adjacent thereto and this radiator serves as an oscillation transformer to step up the voltage applied through transformer 21. Energy is thereby supplied directly at a high potential from the first radiator to the second radiator, which comprises the ground connection 8 and the portions of the conductors 1 adjacent thereto. The second radiator also acts as an oscillation transformer changing the high potential low current energy into the form of lower potential larger current producing an oscillating charging current in ground connection 8 which may be of the same magnitude as the charging current in ground connection 7. The conductors 1 also serve as a transmission line for conveying the high potential energy to the third, fourth and fifth radiators in succession. These radiators function in the same manner as the second ra-

diator so that charging currents of the same order of magnitude are set up in all of the ground connections. As an indication of the advantage which may be obtained by the use of my invention tests have been made with an antenna of the type shown in Fig. 1 which was divided up into 6 individual radiators. When 50 kilowatts of high frequency energy were supplied to the antenna and a single ground connection used a charging current of about 100 amperes was obtained. When six ground connections were used the charging current in each ground connection was about 45 amperes making a total charging current of 270 amperes. In other words the effective radiation with the same amount of energy was about 2.7 times that which was obtained when the antenna was operated as a single radiator.

In accordance with the Hertzian theory of radiation the ability of a certain aerial to radiate is determined by the so-called radiation resistance. This radiation resistance is proportional to the square of the ratio between height and wave length. It is also well known that an antenna to be used efficiently should be operated at a somewhat lower frequency than its natural periodicity. This method of operation calls for a certain amount of inductance which is ordinarily used for tuning. If it is attempted to operate the antenna at a higher frequency than the natural periodicity it is necessary to introduce a capacity instead of an inductance for loading and it is known that the operation in this way is inefficient. For long distance working antennae of large horizontal dimensions are employed. The large horizontal dimensions give high electrostatic capacity and consequently the natural periodicity of the antenna which is determined by the physical dimensions of the aerial is low. Thus if such an antenna is operated at its natural periodicity, or at a lower frequency the wave length is much greater than the height and consequently the ratio between height and wave length results in a low radiation resistance and a high ratio between the radiation resistance and the ground resistance; in other words, in low efficiency. The value to which the ground resistance may be reduced is also limited to a certain extent in practice by the physical dimensions of the antenna. Hence it may be said that such an antenna when used as a simple Hertzian oscillator has a definite maximum possible efficiency or natural ratio between radiation resistance and ground resistance. When, however, the antenna is provided with a plurality of ground connections in accordance with my invention, its natural periodicity is increased beyond the value determined by its physical dimensions when used as a simple Hertzian oscillator,



that is, the natural periodicity of the entire antenna is equal to the natural periodicity of each individual section which is supplied with a ground connection, assuming that the natural periodicity of all of the sections is the same. In other words, the natural periodicity of the antenna is increased to a value much greater than the value which is determined by its physical dimensions. As a result the antenna can be operated efficiently at much shorter wave lengths thereby increasing the radiation resistance inversely with the square of the wave length. The result of this is a more favorable ratio between radiation resistance and ground resistance, since the effect of providing a plurality of ground connections is to decrease the ground resistance; that is, the ratio between radiation resistance and ground resistance or efficiency of the antenna may be greatly increased.

The form of my invention illustrated in Fig. 2 differs from that shown in Fig. 1 merely in its constructional details. In this case each individual radiator takes the form of an umbrella type of antenna and the individual radiators are all connected by a transmission line 22 which supplies high potential energy from the first radiator 23 to the secondary radiators 24, 25, 26 and 27 in succession. A radiating system constructed in this way operates in the same manner as the one illustrated in Fig. 1.

In Fig. 3 I have indicated a modification of my invention which may be employed when it is desired to obtain a directive effect. In this case the individual radiators are separated by inductances 28, 29 and 30 which may be made of such a value as to give the phase displacement in the waves radiated by successive radiators, required to secure the desired directive effect. If desired, condensers may be employed between the individual radiators instead of inductances.

In determining a method whereby a system comprising a plurality of individual radiators may be adapted for directive radiation an antenna such as illustrated in Figs. 1 or 2 may be considered as a uniformly distributed capacity between a linear conductor and ground. The electrostatic field surrounding the conductor extends in three directions but for the purpose of this discussion it will be sufficient to consider the potential gradient only in two directions, that is in the vertical direction between conductor and ground and in the horizontal direction along the conductor. When an aerial conductor is set into oscillation by a source of continuous waves of definite frequency standing waves are formed in the electrostatic field. These waves must be analyzed in accordance with the horizontal as well as the vertical distribution of poten-

nal. If the conductor is not connected to ground in any way it has a natural period of horizontal oscillations. In this case no oscillations will occur in the vertical plane. If one end of the conductor is connected to ground it will have another natural period. The oscillations in this case will be horizontal and also to some extent vertical inasmuch as a charging current will pass between the conductor and ground. An aerial conductor thus arranged with the ground connection at one end has previously been used to considerable extent. If such a conductor is connected to ground through a large number of uniformly distributed coils it becomes a multiple radiating antenna as described previously. Furthermore, if the inductance of these coils is so adjusted that the oscillations in all of the different coils are substantially in phase the antenna may be said to have vertical oscillations but no horizontal oscillations. It is, however, possible to tune the antenna in such a way that it has both vertical and horizontal oscillations simultaneously. The vertical and horizontal oscillations may be of different frequency if a source of energy supply of more than one frequency is available. This might be the case if the antenna was excited by an arc generator or a pliotron oscillator. In the present case, however, it will be most convenient to consider the radiation as of a single frequency such as may occur if the antenna is excited by a high frequency alternator, in which case the horizontal and vertical oscillations that take place simultaneously are necessarily of the same frequency. In the case where the conductor is connected to ground at one end only the horizontal oscillations occur in such a way that the grounded end is a node and the open end has maximum amplitude. It was at one time considered that an antenna of this type would produce a directive radiation. It has now, however, been proved that this is not the case, the reason being that the length of the antenna has been less than one-fourth of the wave length of radiation at which it has been operated, whereas to secure an effective directive radiation it would be necessary that the length of the antenna should be at least equal to one-half of the wave length of radiation. In a simple horizontal antenna such as has been described the distribution of capacity and inductance has always been found to be such that the wave length of the standing wave along the antenna is shorter than the wave length of radiation. This condition, as will be explained more fully hereafter, prevents the securing of the most effective radiation. The fundamental rule which should be followed and which will be explained in the following discussion is that the wave length of the standing wave should be equal to or 13



greater than the wave length of radiation. If radiation is desired in the longitudinal direction of the antenna the standing wave should have a length equal to the wave length of radiation, whereas if a directive radiation is desired at right angles to the direction of the antenna the length of the standing wave should be infinity. For any intermediate angle the relative length of the standing wave and the radiation wave should be equal to the secant of the angle between the direction of radiation and the direction of the antenna. In order to prove this relation geometrically, assume that a wave begins to travel with the velocity of light from one end of the antenna. It is desirable in order to secure maximum efficiency of radiation that the wave as it travels along the antenna should always receive impulses which are in phase with the wave itself. For this reason the standing wave should have a wave length equal to the wave length of the traveling wave. If an antenna oscillates with a standing wave which has a greater wave length than the wave length of radiation, that is, if the wave travels along the antenna at a velocity greater than that of light, the different points of the antenna may be assumed to emit radiation of different phases and the locus for points at which individual waves are of a certain phase may be represented by circles drawn around the different centers of radiation.

Referring now to Fig. 4, assume that the standing wave is represented by  $l_s$ . Around point  $a$  of the standing wave which is represented as a node a circle may be drawn having a radius equal to the wave length of radiation  $l_r$ . Around point  $b$  a circle may be drawn of a radius one-quarter of a wave length shorter. Around point  $c$  the circle has a radius of one-half a wave length and around point  $d$  a radius of one-quarter of a wave length. The line  $t$  which is tangent to all of these circles indicates the direction of radiation, the radiation being greatest in a direction perpendicular to this tangent, and it will be apparent from an inspection of this figure that  $l_r = l_s \cos \alpha$  where  $\alpha$  is the angle between the direction of the antenna and the direction of radiation. Applying the above formula to a case where the standing horizontal wave is shorter than the wave length of radiation the direction of such radiation would be expressed by a cosine greater than unity. This condition being impossible means that no directive radiation can take place and that the radiation will be inefficient.

The type of horizontal antenna connected to ground at one end which has previously been used as such distribution of inductance and capacity that the standing wave is theoretically equal to but in practice has been

shorter than the wave length of radiation. In other words, the wave travels along the antenna at a velocity less than the velocity of light. If it is desired to increase the velocity at which the wave travels along the antenna and thereby lengthen the standing wave either the inductance or capacity must be decreased. Anything however which is done in this direction by changing the combination of the wires will defeat the object sought. An additional parallel wire will decrease the inductance but increase the capacity and fewer parallel wires will decrease the capacity but increase the inductance. By the use of a plurality of radiators such as I have described the desired object may be attained. The capacity between the aerial and ground may be neutralized by distributed inductance between the aerial and ground. If the distributed capacity is entirely neutralized by distributed inductance for the frequency at which the antenna is excited the standing wave will have a length equal to infinity, which means that all parts of the aerial conductor will oscillate in phase. This condition produces non-directive radiation if the antenna is shorter than half of the wave length of radiation and directive radiation at right angles to the antenna if the antenna is sufficiently long in relation to the wave length of radiation. If a long antenna is used and directive radiation is desired at any angle except a right angle, the necessary length for the standing wave may be determined from the wave length of the radiation and the desired angle. The inductance of the aerial being known it will then be possible to calculate the amount of distributed capacity which will create a standing wave of the desired length. This required capacity will be found to be lower than the capacity between the aerial and ground. The method to be followed then will be to neutralize the portion of the capacity to ground which is not desired, leaving a balance of distributed capacity which will give a standing wave of the desired length. Instead of neutralizing the capacity to ground it will be possible to neutralize the longitudinal inductance of the aerial conductor by series condensers. Both of these methods may be used in combination if desired.

If the method of adjusting the tuning of the antenna is considered from the above point of view it will be found that the method of radiation which consists in using a number of independent radiators excited from a common source of high frequency energy in such a way as to operate in phase is only a specific case of a composite horizontal antenna with a horizontal standing wave. This specific case is one where the length of the standing wave is infinity and this method of radiation whether directive or nondirective may be differentiated from



the methods of radiation that have been proposed heretofore by the characteristic that the standing wave has a length equal to or greater than the wave length of radiation, whereas such antennae as have been used previously have had standing waves of a wave length shorter than the wave length of radiation. The term "standing wave" as used in the above description and in the claims which follow is not employed in the restricted sense in which it is commonly understood, namely, as the resultant of two waves traveling with equal velocity in opposite directions so as to produce points of large amplitude and intermediate nodes of zero amplitude. The phenomenon described by this term is also of a different nature than that known as a "traveling wave" since the latter term as ordinarily used implies a complete transfer of energy from one point to another at the same rate that the wave travels. While in the present case energy is transferred from one point to another this transfer is merely incidental as a large portion of the energy remains fixed in position. Moreover, such transfer as does occur may take place in the opposite direction to the traveling wave effect. At any point along the length of the antenna the amplitude of oscillations is the same as at any other point, but when the standing wave, as the term is here used, is of finite length the oscillations of different portions of the antenna are displaced in phase. The maxima of successive portions occur in succession, however, so that the effect, so far as the wave in the ether is concerned, is that of a traveling wave.

While I have illustrated and described the preferred form of my invention, it will be apparent that many modifications therein may be made without departing from the scope of the appended claims.

What I claim as new and desire to secure by Letters Patent of the United States, is:

1. A radiating antenna system comprising a primary radiating unit supplied by a source of radio-frequency current and a plurality of secondary radiating units an individual ground connection for each of said radiating units, the secondary radiating units being connected successively to a transmission line which supplies energy from the primary radiating unit to the secondary radiating units.

2. A radiating antenna system comprising a primary radiating unit and a plurality of secondary radiating units connected successively together and to the primary unit, an individual ground connection for each of said radiating units, a source of high frequency current connected to the primary unit, the primary radiating unit being directly connected to the first of said secondary units and serving as an oscilla-

tion transformer for supplying energy successively to all of the secondary radiating units at a high potential.

3. A radiating antenna system comprising a set of horizontal aerial wires, a plurality of inductance coils connected between said aerial wires and ground at substantially uniformly distributed points along the length of said wires and a source of radio frequency current for supplying energy to the aerial wires at one point, the energy thus supplied being distributed through the aerial wires to maintain synchronous oscillations in each of the oscillating circuits formed by one of said inductances, and the capacity to ground of the portions of the aerial wires adjacent thereto.

4. A radiating antenna system comprising a plurality of sections, all of the different sections being joined together successively by aerial wires, each section consisting of aerial wires connected to ground through an inductance and forming a separate oscillating circuit, and a source of radio frequency current for supplying energy to the aerial wires which join the several sections, each oscillating circuit being tuned to the frequency of the energy thus supplied.

5. The method of supplying energy to a radiating system comprising a plurality of radiating units which consists in supplying energy to one of said units at a comparatively low potential, utilizing said unit as an excitation transformer for producing a comparatively high potential and distributing energy at the high potential thus produced from the first unit successively to all of the other units.

6. The method of maintaining synchronous oscillations in a plurality of radiating units which consists in supplying radio frequency energy directly to one of said units and supplying energy from said first unit successively to all of the other radiating units.

7. The method of radiating electromagnetic energy from a system of horizontal conductors which consists in producing an electrostatic field in said conductors which has a horizontal standing wave formed therein having a wave length which is at least as great as the wave length which is to be radiated.

8. The method of radiating electromagnetic energy from a radiating antenna system which consists in producing by a single source of radio frequency energy an electrostatic field in said radiating system which has a horizontal standing wave formed therein having a wave length which is at least as great as the wave length which is to be radiated.

9. A radiating antenna system comprising a set of aerial conductors, means for exciting said conductors by a single source of radio



- frequency energy, and means for neutralizing, by resonance, the distributed capacity between the aerial conductors and ground, the conductors being so arranged and said means being so adjusted as to produce a standing wave of potential along the aerial conductor having a wave length at least as great as the wave length to be radiated.
10. A radiating antenna system comprising aerial conductors arranged in a horizontal line, a single source of radio frequency current for exciting said antenna system, a plurality of inductances distributed along said aerial conductors and connected between said conductors and ground, said conductors being so arranged and said inductances being adjusted so as to partly neutralize the distributed capacity between the aerial conductor and ground in such a way that the distribution of potential along the aerial conductors will form a standing wave of a wave length at least as great as the wave length to be radiated.
11. The method of radiating electromagnetic energy which consists in charging an insulated continuous system of aerial conductors through a plurality of vertical grounded conductors connected thereto in multiple, the oscillating charging currents in the different ground conductors being regulated so as to have a progressive phase displacement.
12. The method of radiating electromagnetic energy which consists in charging an insulated continuous system of aerial conductors through a plurality of vertical grounded conductors connected thereto in multiple, the oscillating charging currents in the different ground conductors being regulated so that they are progressively shifted in phase to such a degree as to give a directive radiation in a desired direction.
13. The method of radiating electromagnetic energy from a radiating antenna system which consists in neutralizing distributed capacity between said system and ground at a plurality of points in the system, exciting said system by a single source of radio frequency energy, and producing a standing wave of potential along the system having a wave length at least as great as the wave length to be radiated.
14. The method of creating an electromagnetic wave with a directive radiation in a system of aerial wires having a plurality of inductance coils connected between said aerial wires and ground at substantially uniformly distributed points along said wires which consists in producing synchronous oscillating currents in all of the ground conductors by means of energy introduced into the system through one ground conductor and regulating the currents in the different conductors so that they will have a progressive phase displacement.
15. The method of directive signaling which consists in supplying energy from a source of radio frequency current to a radiating unit, supplying energy from said radiating unit to a plurality of other radiating units and adjusting the relative phases of the currents in the different radiating units so that the waves emitted by all of the units add accumulatively at points in a certain predetermined direction.
16. The method of directive signaling by means of electromagnetic waves which consists in supplying energy from a source of radio frequency current to a radiating unit and supplying energy from said radiating unit to a plurality of other radiating units which are so adjusted that the interference effect of the waves emitted therefrom creates a maximum amplitude of signal in a desired direction and a minimum amplitude in another direction.
17. The combination in a radio signaling system of an insulated system of aerial conductors, a plurality of vertical conductors each of which has one end connected to said aerial system and the other end grounded, means for supplying energy to the entire system through one of said vertical conductors to produce synchronous oscillating currents in all of the vertical conductors, and means for adjusting the phase relation of the currents in the different vertical conductors in such a way as to produce a directive radiation.
18. The combination in a radio signaling system of an insulated system of aerial conductors, a plurality of vertical conductors each of which has one end connected to said aerial system and the other end grounded, means for supplying energy to the entire system through one of said vertical conductors to produce synchronous oscillating currents in all of the vertical conductors and means for adjusting the relative phases of the different oscillating currents so that the waves produced by these currents add accumulatively at points in a certain predetermined direction.
19. The combination in a radio signaling system of an insulated system of aerial conductors, a plurality of vertical conductors each of which has one end connected to said aerial system and the other end grounded, means for supplying energy to the entire system through one of said vertical conductors to produce synchronous oscillating currents in all of the vertical conductors and means for adjusting the relative phases of the different oscillating currents so that the interference effect of the waves produced creates a maximum amplitude of signal in a desired direction and a minimum amplitude in another direction.
20. A radiating antenna system comprising a continuous system of aerial conductors



arranged in a horizontal line, a plurality of ground connections for said system containing tuning means located at substantially uniformly distributed points along the length of said system whereby said system is divided into a plurality of radiating units capable of oscillating substantially independent of one another, and means for supplying energy to said system through a single one of said ground connections.

21. A radiating antenna system comprising a system of continuous elevated horizontal conductors, a plurality of ground connections for said system containing tuning means located at substantially uniformly distributed points along the length of said system whereby said system is divided into a plurality of radiating units capable of oscillating substantially independent of one another, and means for supplying energy to said system through the ground connection nearest one end whereby said elevated conductors serve both as a plurality of substantially independent radiating units, and to transmit energy at a high potential from the first radiator to the other radiators in succession.

22. An antenna for a wireless signaling system comprising a long horizontal continuous conducting network supported above the earth and connections between said network and earth at a plurality of successive points along its length whereby the natural periodicity of the antenna is increased beyond the value determined by its physical dimensions when used as a simple Hertzian oscillator, all of said earth connections including inductances adjusted in such a way that the multiple impedance of the inductances is equal to that of a single inductance necessary for tuning the whole antenna at the operating frequency.

23. The combination in a wireless signaling system of an antenna comprising a long horizontal conducting network supported above the earth and connections between the said network and earth at a plurality of successive points whereby the natural periodicity of the antenna is increased beyond the value determined by its physical dimensions when used as a simple Hertzian oscillator, all of said earth connections including inductances, and means for supplying the energy necessary for maintaining oscillations of a single definite frequency in the entire system through one of the multiple paths to ground.

24. The combination in a wireless signaling system of an insulated system of long horizontal continuous aerial conductors, a plurality of successive vertical conductors each of which has one end connected to said aerial system and the other end grounded, and a source of sustained high frequency oscillations for producing synchronous oscillating currents of a single definite frequency in a plurality of multiple paths, each of which comprises a vertical conductor and the space capacity of a portion of the aerial.

25. The combination in a wireless signaling system of an insulated system of long horizontal continuous aerial conductors, a plurality of vertical conductors each of which has one end connected to said aerial system and the other end grounded, and a source of sustained high frequency oscillations for producing substantially in phase oscillating currents of a single definite frequency in all of the vertical conductors.

26. The combination in a wireless signaling system of an insulated system of long horizontal continuous aerial conductors, a plurality of vertical conductors each of which has one end connected to said aerial system and the other end grounded, and a source of sustained high frequency oscillations for producing oscillating currents of a single definite frequency in all of the vertical conductors which differ in phase from one another by less than 90°.

27. An antenna for a wireless signaling system comprising a long horizontal continuous conducting network supported above the earth and having of itself a low natural periodicity and connections between said network and earth at a plurality of successive points along its length, whereby its natural periodicity is increased to a much greater value, all of said earth connections including inductances for tuning said antenna.

28. The combination in a wireless signaling system of an insulated system of continuous aerial conductors, a plurality of vertical conductors each of which has one end connected to said continuous aerial system and the other end grounded, means for producing synchronous oscillating currents in all of the vertical conductors, and means for adjusting the phase relation of the currents in the different vertical conductors in such a way as to produce a directive radiation.

29. The combination in a wireless signaling system of an insulated system of continuous aerial conductors, a plurality of vertical conductors each of which has one end connected to said continuous aerial system and the other end grounded, means for producing synchronous oscillating currents in all of the vertical conductors, and means for adjusting the relative phases of the different oscillating currents so that the waves produced by these currents add accumulatively at points in a certain predetermined direction.

30. The combination in a wireless signaling system of an insulated system of continuous aerial conductors, a plurality of vertical conductors each of which has one end



connected to said continuous aerial system and the other end grounded, means for producing synchronous oscillating currents in all of the vertical conductors, and means  
 5 for adjusting the relative phases of the different oscillating currents so that the interference effect of the waves produced creates a maximum amplitude in a desired direction and a minimum amplitude in another direc-  
 10 tion.

31. An antenna for a wireless signaling system comprising a long horizontal conductor insulated from the earth and having such natural constants that an electrical  
 15 wave will travel along its length at a velocity less than the velocity of light, and means uniformly distributed along the length of said conductor for increasing the velocity at which an electrical wave will  
 20 travel along the conductor.

32. An antenna for a wireless signaling system comprising a long horizontal conductor insulated from the earth and having such natural constants that an electrical  
 25 wave will travel along its length at a velocity less than the velocity of light, and means uniformly distributed along the length of said conductor for increasing the velocity at which an electrical wave will  
 30 travel along the conductor to a velocity at least equal to the velocity of light.

33. An antenna for a wireless signaling system comprising a long horizontal conductor insulated from earth and having  
 35 such natural constants that an electrical wave will travel along its length at a velocity less than the velocity of light, and a plurality of inductances uniformly distributed along the length of the conductor  
 40 and connected between the conductor and

earth for neutralizing a portion at least of the shunt capacity thereof and thereby increasing the velocity at which an electrical wave will travel along the conductor.

34. An antenna for a wireless signaling  
 45 system comprising a long horizontal conductor insulated from earth and having such natural constants that an electrical wave will travel along its length at a velocity less than the velocity of light, and a  
 50 plurality of inductances uniformly distributed along the length of the conductor and connected between the conductor and earth for neutralizing a portion at least of  
 55 the shunt capacity thereof and thereby increasing the velocity at which an electrical wave will travel along the conductor to a velocity at least equal to the velocity of light.

35. An antenna for a wireless signaling  
 60 system comprising a long horizontal conductor insulated from earth and having such natural constants that an electrical wave will travel along its length at a velocity less than the velocity of light, a plu-  
 65 rality of inductances uniformly distributed along the length of the conductor and connected between the conductor and earth for neutralizing a portion at least of the shunt capacity thereof, and thereby increasing the  
 70 velocity of the electrical wave in the conductor, and a plurality of inductances connected in series with said conductor between the different earth points for decreasing the  
 75 velocity of the electrical waves in the conductor to a desired value.

In witness whereof, I have hereunto set my hand this 11th day of September, 1917.

ERNST F. W. ALEXANDERSON.

# Raymond Heising

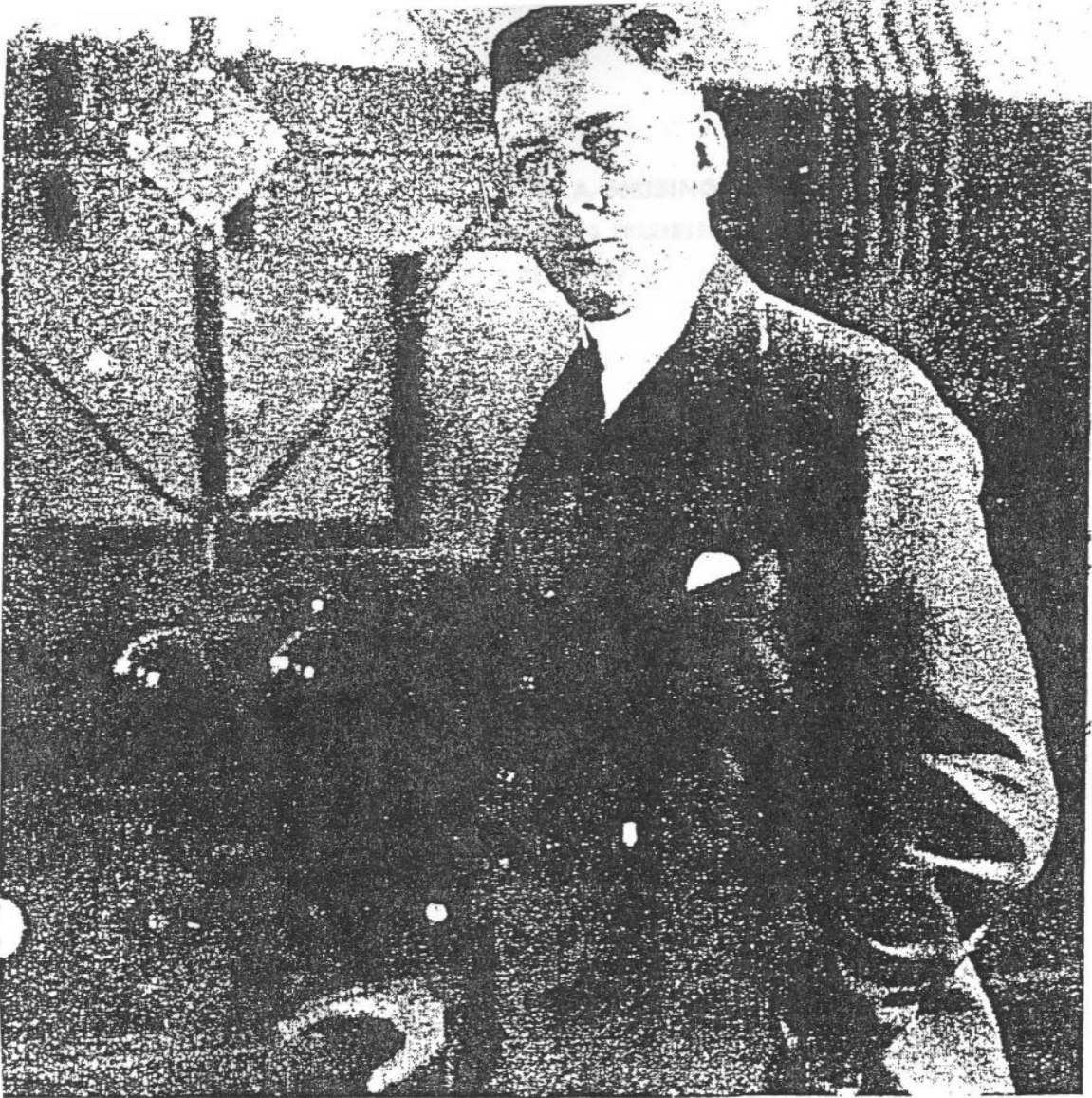

Adaptation of Third Generation Electrostatic Wireless  
(end of period)  
US Patent #1,562,961  
Yet to be developed to its full potential



Nov. 24, 1925.

1,562,961

R. A. HEISING

DIRECTIVE RADIO TRANSMISSION SYSTEM

Filed May 16, 1921

4 Sheets-Sheet 1

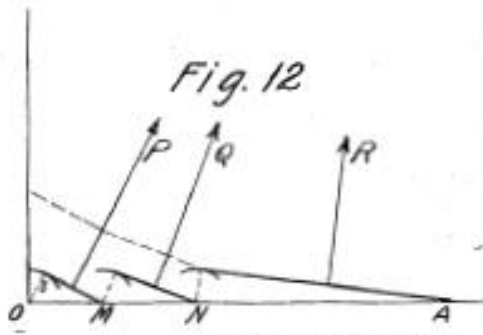
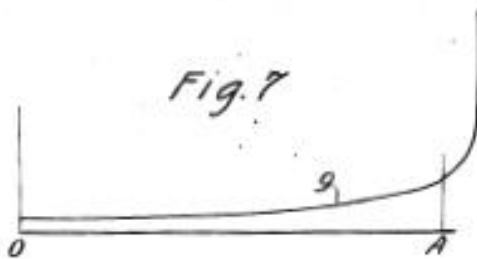
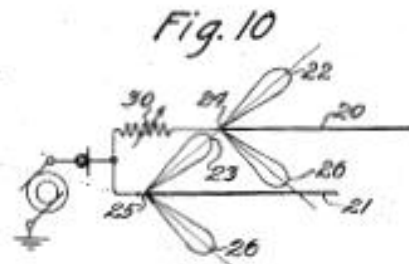
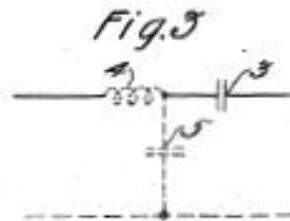
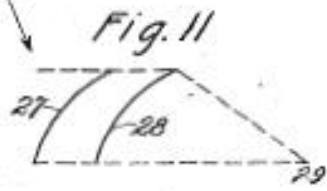
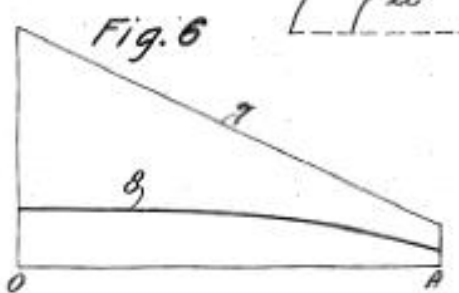
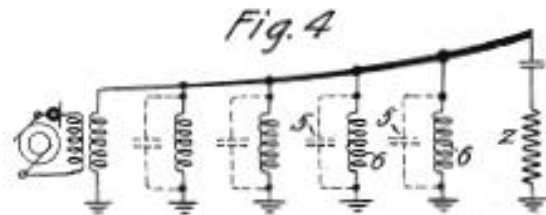
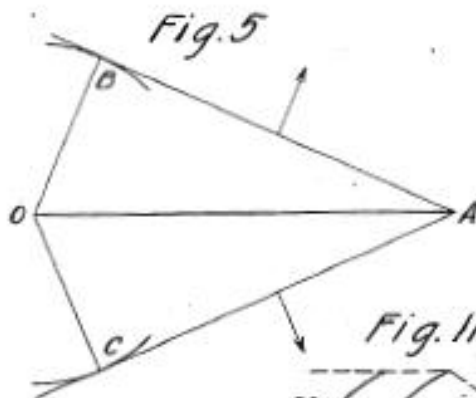
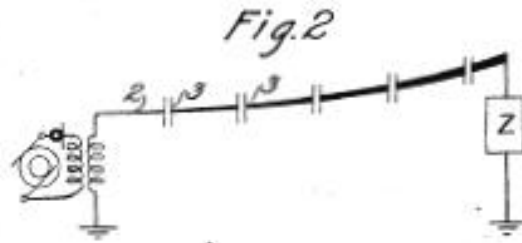
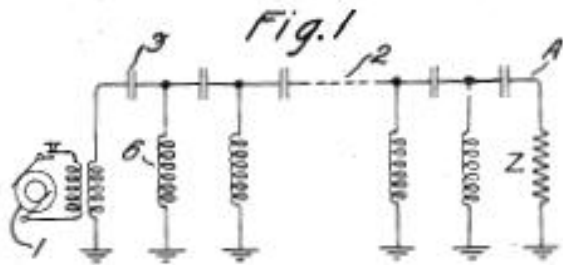

Inventor:  
Raymond A. Heising  
by C. C. Sprague, Att'y.

Fig. 8

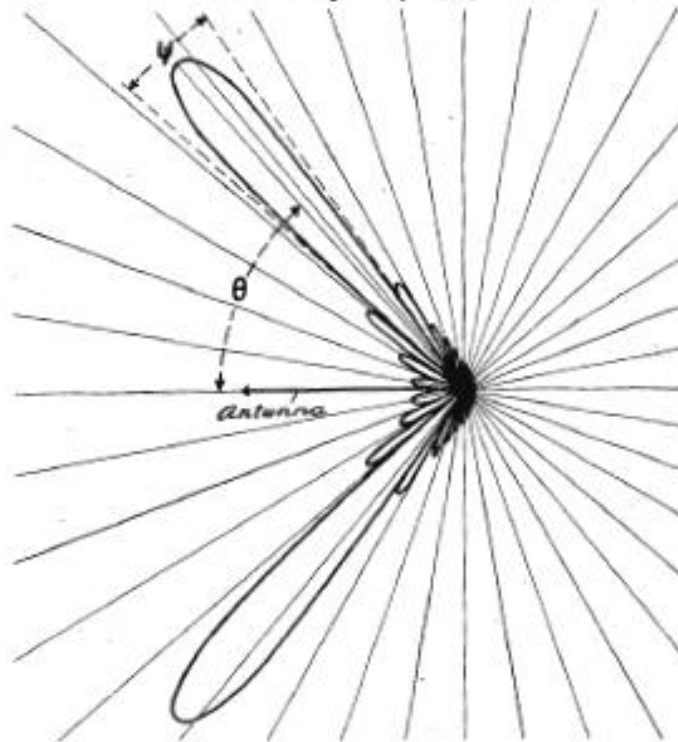
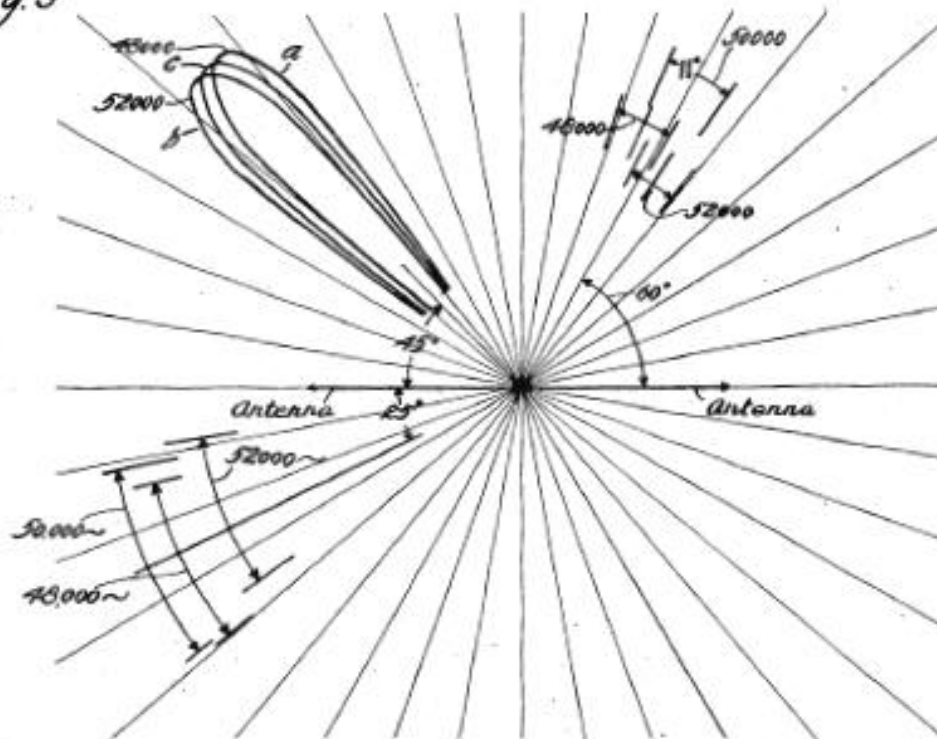

Fig. 9



Inventor:  
Raymond A. Heising  
by C. C. Sprague. ATT'Y.



R. A. HEISING

DIRECTIVE RADIO TRANSMISSION SYSTEM

Filed May 16, 1921

4 Sheets-Sheet 3

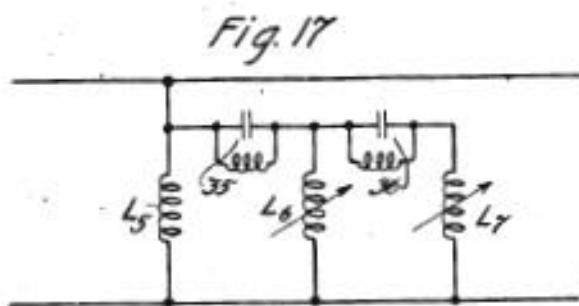
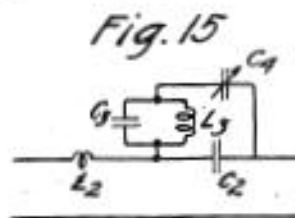
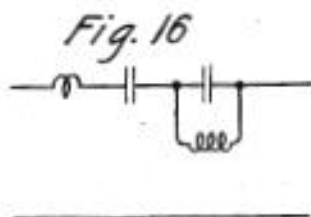
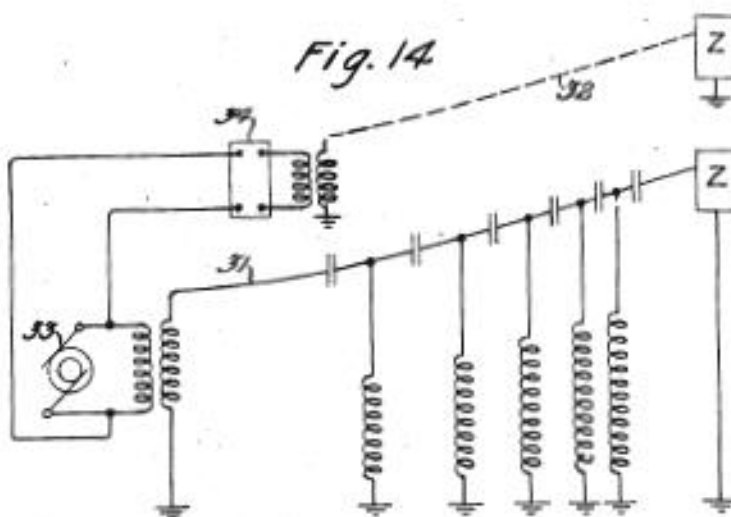
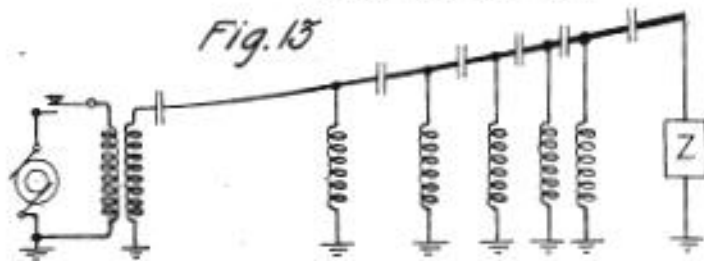

Inventor:  
Raymond A. Heising  
by C. C. Sprague ATT'Y.





# UNITED STATES PATENT OFFICE.

RAYMOND A. HEISING, OF MILBURN, NEW JERSEY, ASSIGNOR TO WESTERN ELECTRIC COMPANY, INCORPORATED, OF NEW YORK, N. Y., A CORPORATION OF NEW YORK.

## DIRECTIVE RADIO TRANSMISSION SYSTEM.

Application filed May 16, 1921. Serial No. 470,042.

*To all whom it may concern:*

Be it known that I, RAYMOND A. HEISING, a citizen of United States of America, residing at Milburn, in the county of Essex, State of New Jersey, have invented certain new and useful Improvements in Directive Radio Transmission Systems, of which the following is a full, clear, concise, and exact description.

This invention relates to directive transmission of energy and more particularly to methods of and systems for directionally radiating and absorbing electric waves.

An object of the present invention is to provide a transmission system for radiating energy directionally. Another object of the

invention is to provide a focussing antenna which will concentrate the radiated energy at a distant point.

The propagation velocity of wave in any medium is in general the product of its frequency and its wave length in that medium. In the case of free electric waves, the propagation velocity is approximately 300,000,000 meters per second. In the case of guided electric waves, the wave length and the wave propagation velocity are functions of the electrical constants of the guiding transmission conductors. As given by Heaviside, the wave lengths of a sustained wave over a circuit having uniformly distributed inductance and capacity is

$$(1) \lambda = \frac{2\pi}{\sqrt{\frac{1}{2} \left\{ \sqrt{(SR + \omega^2 LC)^2 + \omega^2 (LS - CR)^2} - (SR - \omega^2 LC) \right\}}}$$

where  $\lambda$  is the wave length,  $\omega$  is the angular velocity or the wave frequency multiplied by  $2\pi$  and S, R, L, and C are respectively the shunt conductance, series resistance, series inductance, and shunt capacity of the circuit per unit length. This wave length evidently depends upon the magnitudes of these four electrical characteristics per unit length of the circuit. By varying these it is possible to increase or decrease the wave length of the sustained wave and accordingly to vary the wave propagation velocity along the circuit. If a loaded circuit of this character is used for radiating or absorbing electric waves, the waves, if sustained sine waves, may be propagated along the circuit at a greater velocity than that at which they progress in the ether. If a definite small part of a transmitting antenna be considered, the energy of the wave proceeding along the circuit as a guided wave and partly radiated and propagated out through the surrounding space. The shape of the resultant wave front in the ether will be dependent upon the relative velocities of wave propagation in the two media. It is, therefore, possible to give a radiated wave variously directed fronts depending upon the loading of the antenna circuit. It is likewise possible to so absorb the directed radi-

ant wave at a receiving antenna as to cause all of the absorbed energy to cumulatively affect the receiving device.

According to the present invention a radio transmitting or receiving antenna is made long with respect to the wave-length of the wave to be transmitted or received. In order to make this antenna behave as a conductor of infinite length and thereby avoid the production of a reflected wave, it is desirable to terminate it in an impedance element having an impedance equivalent in magnitude and character to the iterative or surge impedance of the antenna itself at the terminating point. At intervals corresponding to a fraction of a wave-length, the antenna is loaded by inserting series capacity or shunt inductance or both to make its wave propagation velocity for the waves to be transferred higher than the corresponding wave propagation velocity in ether. Since the energy in a radiating antenna decreases with increasing distance from the source, it is desirable in order to secure the best results to progressively increase the radiating factor of the antenna and this is done by increasing its height.

The invention permits radiation in one lateral direction to the substantial exclusion of radiation in any other by an arrangement of parallel antennae. For focussing on a



fixed receiving point the loading of the transmitting antenna may be progressively increased so as to progressively change the direction of the wave front of the emitted wave. The antenna may also be curved laterally to add to the focussing effect. For multiplex operation, waves of a plurality of different frequencies may be focussed at the same or different points by loading the antenna in different manners for waves of each of the different frequencies.

Other objects of the invention will be apparent upon consideration of the following detailed description taken in connection with the accompanying drawing in which Figure 1 illustrates diagrammatically a loaded antenna long with respect to the wave length of the emitted wave; Figure 2, a radio transmission arrangement including series capacity loading for increasing the wave propagation velocity; Figure 3, a unit section of the conductor of Figure 2; Figure 4, an antenna system provided with shunt inductance loading; Figure 5, a diagram indicating the directive operation of loaded antennæ; Figure 6, a diagram of current and energy distribution in antennæ of the type disclosed; Figure 7, the radiating coefficient diagram for antennæ of this type; Figure 8, a polar diagram showing the distribution of the radiated wave amplitude in various angular zones; Figure 9, a polar diagram showing the distribution of energy of a modulated carrier wave; Figure 10, an antenna system for neutralizing the directed energy in one direction; Figure 11, an arrangement of laterally curved antennæ for focussing energy at a distant receiving station; Figure 12, a diagram indicating the operation of a second type of focussing system depending upon progressive change in loading; Figure 13, an antenna arrangement for this second type of system; Figure 14, a directive focussing system employing both capacity and inductance loading; Figures 15 to 17 illustrate details of loading arrangements applicable to any of the foregoing systems; Figure 18, a receiving system with a loaded antenna; and Figure 19, a multiplex system for focussing a plurality of different waves.

Referring to Figure 1, a source 1 is associated with an antenna 2 to supply energy thereto for radiation. Antenna 2 is preferably of a length several times the wave-length defined in equation (1). This wave-length depends upon the inductance and capacity per unit length of the radiating circuit. In loaded telephone lines with inductances, as is the common practice, the wave-length is greatly shortened. In fact, in loaded line telephone practice, the wave-length multiplied by the frequency may give a velocity of the order 90,000,000 meters per second instead of 300,000,000 meters per

second which is the velocity of light and of free electric waves. Since increasing the inductance per unit length which is done in loading telephone lines, shortens the wave-length at a given frequency, it will be evident that it is possible by reducing the inductance per unit length, to increase the wave-length of a unit circuit. If the resistance and shunt conductance of the circuit are made zero, equation (1) reduces to

$$(2) \lambda = \frac{2\pi}{\omega\sqrt{LC}}$$

From equation (2) it would appear that, with circuits of negligible series resistance and shunt conductance per unit length, either reducing the series inductance per unit length or the shunt capacity per unit length, should increase the wave length and, therefore, increase the velocity at which a given frequency wave is propagated along the circuit. This can actually be accomplished in several ways it being remembered that the long antenna with its capacity to ground and the return ground conducting path may, if uniform and if properly terminated, be treated as any other alternating current conducting circuit. One simple way to increase the velocity of the wave propagation is illustrated in Fig. 1 in which series loading capacities 3 and shunt inductances 6 are inserted in the conducting line and are spaced much in the same manner as are the loading inductances in loaded telephone lines. These loading inductances and capacities should be separated by distances small compared to a wave length, so that the effect of uniform distribution of the capacity is approximated. Although the exact number of such elements may vary greatly, it is desirable to use eight or more per unit length. For simplicity only a few elements are shown. The action of this capacity loading is to introduce series reactance opposite in sign to that of the natural series inductance, and accordingly to produce lower effective series inductance per unit length. The action of the inductance loading is to introduce shunt reactance opposite in sign to that of the natural shunt capacity and hence to produce lower effective shunt capacity reactance per unit length. It will, of course, be understood that either series capacity loading or shunt inductance loading alone may be used.

As has been previously mentioned, a circuit of this character of finite length must be properly terminated to avoid having a wave reflected from the free terminal. A reflected wave produces nodes along the circuit and introduces complications of various sorts. If the transmitted wave gives directive radiation in the general direction of its transmission the reflected wave will give



directive radiation in the opposite direction. To eliminate the reflected wave and prevent this reverse transmission, it is only necessary to terminate the line with a proper impedance  $Z$ , the value of which may be computed from well known transmission equations.

Fig. 2 illustrates a modification of the arrangement of Fig. 1 in which series capacity loading is employed. Conductor 2 is progressively elevated to increase the radiating factor so as to maintain the energy radiation as nearly equal as possible at all points along the antenna. To maintain the unit shunt capacity constant with increasing height a conductor of increasing size is employed. An element of the recurrent network thus formed is illustrated in Figure 3, in which the natural series inductance 4 and shunt capacity 5 of the conductor, both indicated by dotted lines, constitute together with the loading capacity 3 a uniform section of the line.

Fig. 4 illustrates another method of antenna loading which consists in reducing the effective shunt capacity of the circuit. This is accomplished by connecting between the line and ground, loading inductances 6 which are preferably spaced eight or more to the wave length, although in this case as well as in the case of the series capacity loading, a considerable variations in this number may be permitted. It is a well known fact that the effective capacity of a condenser is reduced by connecting in parallel with it a large inductance. The effective reactance of the condenser is increased. At a given frequency the natural capacity 5 of a unit section of the conductor with the inductance 6 shunted around it has several times the capacitive reactance which the capacity 5 alone has. Resistance tends to shorten the wave length. It is accordingly desirable to make the resistance of the antenna conductor very low. In loading systems of the kind described, the variations in effective capacity or effective inductance will be particularly marked for a given frequency, and wave velocities for such frequencies may be attained exceeding that of light.

The fact that a wave may be made to travel over a circuit with a velocity greater than that of free electric waves or light, may be made use of in directive transmission. Referring to Figure 5 in which OA represents a plan or top view of a long loaded antenna of the type illustrated in Figures 2 and 3, suppose that the source of waves is located at terminal O. An electrical disturbance occurring as an alternation of electrical potential at this point travels along the circuit to a point A. By radiation point O becomes the center of a disturbance of like form which emanates in all directions through space. If the space velocity i. e., the velocity of free electric waves is such that

the radiated wave travels a distance OB during the time that the guided wave travels the distance OA, the wave front of the radiated wave in the space surrounding the antenna will take the directions BA and CA. The direction of propagation of the radiated wave being perpendicular to this front is indicated by the arrows. The angle between this wave front and the antenna evidently depends upon the ratio of the guided wave velocity to the free wave velocity. If right angle triangles are drawn similarly to Fig. 5 for the case where the base OA equals the radii OB and OC, the hypotenuses AB and AC will be infinitely short and at right angles to the base OA. This illustrates the critical case in which the ratio of velocities is unity. When this ratio is unity, the wave will accordingly be propagated in the direction of transmission along the circuit, i. e., OA. The physical basis for the phenomenon when the ratio is unity is made readily apparent by noting that as the wave is radiated in the direction of antenna OA, since the wave is propagated along the antenna at the same velocity, new centers of oscillation are continuously being established on the wave front which in turn gives rise to waves which travel in the direction OA coincidentally with those from the original wave source O and having the same phase. There accordingly results a reinforcing of the wave in the direction OA. The original wave and the waves radiated from these centers of oscillation in the opposite direction are opposed in phase and mutually extinguish each other. When the ratio is infinite the wave front will obviously be parallel to the conductor and the direction of propagation will be perpendicular to the antenna. When this ratio is less than unity, the antenna is not directive.

In Figure 4, the terminating element  $Z$  is shown as comprising series resistance and capacity. That the terminating impedance may be closely approximated by resistance alone will be evident from a consideration of the specification of United States patent to Heising 1,313,483, patented August 19, 1919.

In order to secure best results, the directed wave should be of uniform intensity throughout its wave front. This requires that the radiation in power should be the same for each unit length along the line. In a line having uniform resistance, inductance, and capacity, the current decreases logarithmically, and the radiation will accordingly be non-uniform. If the energy is to be uniformly radiated, the remaining energy in the guided carrier wave should decrease uniformly from the terminal O of the antenna to the terminal A, where the remainder of the energy should be absorbed by the terminating impedance  $Z$ . In order



to secure an energy distribution of this character as illustrated by line 7 of Figure 6, the current along the circuit must vary as the square root of the energy as represented by curve 8 of Figure 6. In order that the radiated power may be uniform along the line with decreasing current, it will be evident that the radiating constant of the antenna or its radiation resistance must be gradually increased along the line. It should vary according to the reciprocal of the square of the current amplitude, as indicated by curve 9 of Figure 7 which represents the radiation coefficient or radiation resistance. Since the radiation resistance varies approximately as the square of the height of the line, this variation in resistance may be secured by varying the height of the line so as to make this height approximately proportional to the square root of the required radiation resistance. This is indicated in Figures 2 and 4 in which the height of the line increases from the source to the remote terminal in accordance with the requirement just stated. The gradually increasing height with decreasing current will produce uniform radiation throughout the length of the conductor. Inasmuch as the energy remaining at A is absorbed in the terminating network Z, it is possible to terminate the line at such a point that the height of the antenna will not, because of the very small current, be required to exceed practical limits in order to maintain constant radiation.

With an antenna of varying height and a constant size conductor, the inductance and capacity per unit length will change. It is possible to progressively vary the magnitudes of the loading reactances along the line so as to maintain the wave velocity constant. As an alternative method the diameter of the conductor itself may vary progressively with the height. With this latter arrangement the loading inductances and capacities may remain the same per unit wave length if a constant wave velocity is to be maintained throughout the length of the conductor. Figures 2 and 4 indicate a variation in the diameter of the conductor to maintain the capacity per unit length substantially constant.

Figure 8 shows a complete radiation curve with the wave amplitude as a function of its angular direction from a particular loaded line antenna of twelve times the wave length. The position and direction of extension of the antenna is indicated by the arrow. The principal energy falls within a sector of a  $14^\circ$  angle marked  $\psi$ . Small amounts fall in other directions due to interference. Increasing the length of the antenna to twenty-four wave lengths would cut the angular width of the transmission loop in two and would reduce the size of

the small loops representing power transmitted in other directions.

In radio telephony when modulating a carrier wave in accordance with speech, a band of waves of different frequencies results. If for example, a carrier wave of 50,000 cycles frequency is used and the range of the frequency of essential speech currents is about 2,000 cycles, the modulated energy will have frequencies ranging from 48,000 to 52,000 cycles. In a system of this kind these various frequency waves will travel along the loaded antenna with different velocities due to the fact that the effective inductive reactance or effective capacitive reactance per unit length changes with frequency. If a carrier wave of 50,000 cycles frequency is radiated from an antenna twelve wave lengths long, at a  $45^\circ$  angle, as shown by the curve of Figure 9, the 48,000 and 52,000 cycle frequency waves will be spread out in different directions, as shown by curves *a* and *b* respectively of the same figure. In this case the dispersion is not particularly harmful as there is sufficient amplitude of both of the extreme frequency waves occurring in the  $45^\circ$  angle direction to give a very good signal. Similarly, if waves of this frequency are radiated in a  $25^\circ$  direction, as shown in the same figure, there will be a good quality of speech transmitted from the energy produced over an angle several degrees in width. If, however, the transmission angle is  $60^\circ$ , as shown in the same figure, the 52,000 and 48,000 cycle waves overlap very slightly and a change in quality is apt to result. In Fig. 9, the position and direction of extension of the antenna is indicated, for the respective directions of maximum directivity, in a manner similar to that of Fig. 8.

The transmission angle depends upon the propagation velocity. A larger transmission angle accordingly requires a larger propagation velocity which in turn causes a larger difference between the propagation velocities along the line, of the different frequency components. Accordingly the differences in direction of the various frequency components, are accentuated as the transmission angle of the band as a whole is increased. If waves of frequencies lower than 50,000 cycles are used as a carrier, these variations will become still larger and it is, therefore, of advantage to use high carrier frequencies.

As is diagrammatically indicated in Fig. 5, there is directive radiation in two lateral directions. An arrangement of multiple antennae for suppressing radiation in one of these directions is illustrated in Figure 10 in which parallel directive antennae 20 and 21 are so spaced that their respective energy transmission loops 22 and 23 from the terminals 24 and 25 connected with the



source extend in the same direction, and neutralize in space. If energy of the same phase is simultaneously supplied at points 24 and 25, and if these points are a half wave length apart in one direction in which their respective antennae radiate most powerfully, the effect of the energy radiated from point 25 will be to oppose and neutralize that radiated from point 24 in this direction. This is for the reason that for all points in space in this direction these radiated energies will be opposite in phase. In other words loop 22 will neutralize loop 23. If the distance between the points 24 and 25 does not correspond to a half wave length, the phase of the energy supplied to one of the antennae may be so shifted by a variable impedance device 30 that the points 24 and 25 will tend to radiate energies which will neutralize in space in the direction of the loops 22 and 23. This will leave only the loops 26 which are similarly directed and which are additive.

If it is desired to focus on a distant station, the directive antenna may be curved in direction as indicated in Figure 11 in which the two curved antennae 27 and 28 are each given such curvature as to focus the radiated energy on a receiving station at 29. In general, in the case of curved antennae it will be possible to obtain only roughly approximate neutralization by the use of two antennae. Certain special cases, as for example, that where the antennae extend along arcs of concentric circles and are arranged to focus their radiated energy at the center may give fairly exact neutralization.

A focussing effect could also be obtained by increasing the wave propagation velocity along the line so that in the region of one terminal of the line, the wave will be propagated at a greater rate than in the region of the other terminal. The operation of this will be clear from an inspection of Figure 12, in which an antenna OA is so loaded that a wave of given frequency applied at O will be propagated, in the first unit of time from O to M, in the second unit from M to N, in the third unit from N to A. Suppose that each portion OM, MN, and NA is, throughout its length, composed of like recurring sections. If the propagation velocity of the unguided waves when radiated be OS per unit of time, the radiated wave from portion OM will have a front, the direction of propagation of which is indicated by arrow P. The direction of the radiated wave of portion MN will be as indicated by Q, and that from portion NA as indicated by R. If the loading is made to progressively vary so that the wave length progressively varies, a smoothly curved wave front will obviously result. Figure 13 indicates diagrammatically an antenna loaded in this manner by a progres-

sively closer spacing of the loading capacity or shunt inductance elements, or both. Instead of closer spacing of capacity elements of the same size the capacitances of the successively capacity elements may be progressively smaller, thus giving the same series capacity effect. In a similar manner instead of closer spacing of the shunt inductance elements, the shunt inductance elements may be uniformly spaced and their reactances may be progressively diminished in magnitude.

A desirable form of loaded antennae is shown in Figure 14 in which the two antennae 31 and 32, which may be either straight or laterally curved according to the arrangement of Figures 10 or 11, are arranged with corresponding points equidistantly spaced. A source 33 supplies energy to both these antennae over parallel circuits one of which includes a phase changing device 34. This serves, as in the arrangement of Figure 10, to maintain the energies emitted from corresponding points of the two antennae at the proper relative phases such that the energy radiated from one antenna will neutralize that radiated from the other in one direction. Each antenna comprises both series capacity and shunt inductance loading, thus combining the arrangement of Figures 2 and 4. The antennae are progressively varied in height from the source to their remote terminals in order to maintain constant the energy radiated per unit length. Each antenna terminates in an impedance element Z which is designed to absorb the residual unradiated energy reaching the remote terminal.

Figure 15 illustrates a section of an antenna circuit loaded for waves of two different frequencies.  $L_1$  and  $C_1$  indicate respective series inductance including the natural inductance of the circuit and series capacity which together give a capacity reactance at one of the desired frequencies. The shunt path  $L_2, C_2, C_3$  does not affect current of this desired frequency, since  $L_2$  and  $C_2$  constitute an antiresonant loop having substantially infinite impedance at that one frequency. The shunt path may, therefore, be regarded as open for the frequency considered. For current of a second frequency, the path  $L_2, C_2$  is conductive and the net reactance of the whole unit at this frequency may be varied by varying  $C_3$  so as to give any reactance desired for the second frequency current. Of course, an additional shunt path such as  $L_3, C_3, C_4$  could be used for another frequency by shunting such a path about condenser  $C_4$  and including in it a tuned loop or antiresonant circuit to exclude current of the second frequency. In this manner, the number of different frequency currents may be increased as much as desired.

Figure 16 represents a circuit having two



degrees of freedom and which can be adjusted to give the same desired reactances as are given by the arrangement of Fig. 15. This circuit may accordingly replace that of Fig. 15. Its exact adjustment is, however, considerably more difficult.

Figure 17 illustrates an adaptation of the principle of Figure 15 applied to shunt inductance loading.  $L_1$  represents a unit shunt loading inductance designed in accordance with the principles previously laid down for currents of one given frequency. The anti-resonant loop 35 tuned to this one frequency effectively cuts off the other shunt paths for such currents. The loop 35 admits currents of the second frequency and a variable inductance  $L_2$  permits the network  $L_1, 35, L_2$  to give the proper inductive reactance for the second frequency current. Loop 36 in the third path is antiresonant to and effectively excludes currents of the second given frequency for which variable inductance  $L_3$  provides the desired reactance. It conducts a third frequency for which  $L_1$  together with the rest of the network may determine the desired reactance.

Figure 18 illustrates a receiving system with progressively changing loading elements. The conventional receiving element is coupled to the antenna in the ordinary manner and is preferably designed to introduce therein the proper terminating resistance to avoid reflection loss in accordance with the principle previously stated.

Figure 19 shows a multiplex transmitting system equipped with three carrier wave sources and an antenna loaded in the manner of Figure 17. Transmitting keys are associated with two of the sources and a microphone with the third, but it is to be understood that these are merely representative of any desired arrangements for modification of the carrier waves.

Throughout the specification the various features of the invention have been explained from the standpoint of radiation at a transmission station. The principles of wave absorption are in general the same as those of wave radiation. It is, therefore, to be understood that the various features of the invention are equally applicable to receiving systems and the various circuit diagrams may each be considered as representations of a receiving system with the simple substitution of receiving apparatus for the carrier wave source.

In the appended claims the transfer of energy either by radiation from an antenna to the ether or by absorption from the ether to the antenna is analogous to the transfer of energy between media of different characteristics. In telephone parlance the term "transducing" is commonly used to describe generally a transfer of energy without limitation as to the nature of the transfer.

Wherever this term occurs in the appended claims, it will be understood that it is intended to be generic both to radiation and absorption of wave energy as well as to the transfer generally of energy from a medium of certain characteristics to media of different characteristics.

What is claimed is:

1. A method of directive radio transmission, utilizing a source of carrier waves and a linear radiating conductor connected therewith, which comprises the steps of radiating a portion of the waves from said source into space, transmitting another portion of said waves along the conductor, absorbing a portion of the energy thus transmitted at points in the conductor, radiating the absorbed energy from said points and preventing reflection of the unabsorbed transmitted waves at the remote terminal.
2. The method of wave transmission which comprises radiating from a conductor very long with respect to the wave length of the radiating energy an amount of energy per unit length of said conductor substantially uniform throughout the entire length of said conductor.
3. The method which comprises propagating an electric wave along a linear conductor at a wave propagation velocity exceeding that of light and radiating a substantially uniform amount of wave energy from each unit length of said conductor.
4. The method of directive radio transmission, utilizing a conducting element, which comprises propagating said waves along the conductor, causing the propagated velocity to differ in a systematic manner at different points in said conducting element, absorbing a portion of the energy from the wave propagated thereacross at each element of the conductor, and radiating said absorbed energy.
5. The method of directive transmission comprising propagating waves along a conductor at a velocity exceeding that of light and progressively varying the velocity of propagation throughout the length of the conductor.
6. The method of electric wave transmission, using a long conductor, which comprises supplying periodic energy to said conductor and propagating it at progressively increasing velocities throughout the length of the conductor.
7. A loaded circuit having loading reactances progressively varying in magnitude throughout its length so as to vary the wave propagation velocity for waves of a given frequency.
8. A directive transmitting antenna comprising a loaded circuit having its loading constants so adjusted that waves of a given frequency are propagated thereover at a velocity exceeding that of light and a termi-



nating impedance connected thereto for absorbing, without reflection, energy transmitted to said impedance.

9. In a directive radio transmitting system in combination, a transmitting antenna, a source associated therewith for supplying continuous waves to said antenna and a terminating element connected to said antenna for preventing reflection of said waves back toward said source.

10. In a directive radio transmitting system in combination, a transmitting antenna, means for supplying periodic energy thereto, said antenna being so loaded as to transmit the wave form of said energy at a velocity exceeding that of light and a terminating impedance connected to said antenna to prevent retransmission of energy back to said means.

11. In combination, a long horizontal antenna, a source of periodic energy associated therewith for supplying energy thereto, and means for causing said antenna to radiate a uniform quantity of the supplied energy per unit length of the antenna.

12. In combination, a long antenna, means connected to one terminal thereof for supplying periodic energy thereto, and means for changing the radiation resistance of said antenna progressively throughout its length so as to keep the quantity of radiated energy constant per unit length.

13. An antenna, means for supplying a periodic wave of a given frequency thereto and means for progressively varying the wave propagation velocity of said antenna whereby the radiated energy of said wave may be directly focussed upon a distant point.

14. A conductor curved upwardly throughout its length, and means for so loading said conductor as to cause it to radiate energy directly throughout its length.

15. A method of directive radio transmission, utilizing a source of carrier waves and a linear radiating conductor connected therewith, which comprises the steps of radiating a portion of the waves of said source into space, transmitting another portion of said waves along the conductor, absorbing a portion of the energy thus transmitted at points in the conductor, radiating the absorbed energy from said points, neutralizing the radiation from said conductor in one direction, and preventing deflection of the unabsorbed transmitted waves at the remote terminal.

16. The method which comprises propagating an electric wave along a linear conductor at a wave propagation velocity exceeding that of light, radiating a substantially uniform amount of wave energy from each unit length of said conductor, and neutralizing the radiation from said conductor in one direction.

17. The method of directive radio trans-

mission, utilizing a conducting element, which comprises propagating said waves along the conducting element, causing the propagated velocity to differ in a systematic manner at different points in said conducting element, absorbing a portion of the energy from the wave propagated thereacross at each element of the conducting element, radiating said absorbed energy, and neutralizing the radiation from said conducting element in one direction.

18. The method of directive transmission comprising propagating waves along a conductor at a velocity exceeding that of light, progressively varying the velocity of propagation throughout the length of the conductor, and neutralizing the radiation from the conductor in one direction.

19. A loaded circuit having loading reactances progressively varying in magnitude throughout its length so as to vary the wave propagation velocity for waves of a given frequency, whereby said circuit tends to radiate directly in lateral directions, and means for neutralizing the radiation in one of said directions.

20. A directive transmitting antenna comprising a loaded circuit having its loading constants so adjusted that waves of a given frequency are propagated thereover at a velocity exceeding that of light, whereby said circuit tends to radiate directly in lateral directions, a terminating impedance connected to said circuit for absorbing, without reflection, energy transmitted to said impedance, and means for neutralizing the radiation in one of said directions.

21. A loaded circuit having loading reactances progressively varying in magnitude through its length so as to vary the wave propagation velocity for waves of a given frequency, whereby said circuit tends to radiate directly in lateral directions, and means for neutralizing the radiation in one of said directions, said means comprising a second loaded circuit arranged in parallel with the first loaded circuit.

22. In combination, a source of energy and connected thereto a loaded circuit having loading reactances progressively varying in magnitude throughout its length so as to vary the wave propagation velocity for waves of a given frequency, whereby said loaded circuit tends to radiate directly in lateral directions, and means for neutralizing the radiation in one of said directions, said means comprising a second loaded circuit arranged in parallel with the first loaded circuit with respect to said source, and including a phase shifting means, whereby the energies supplied to said loaded circuits have a desired phase difference.

In witness whereof, I hereunto subscribe my name this 13th day of May A. D. 1921.

RAYMOND A. HEISING.

# FOUR QUADRANT REPRESENTATION OF ELECTRICITY

<http://fourquadranttheory.com>

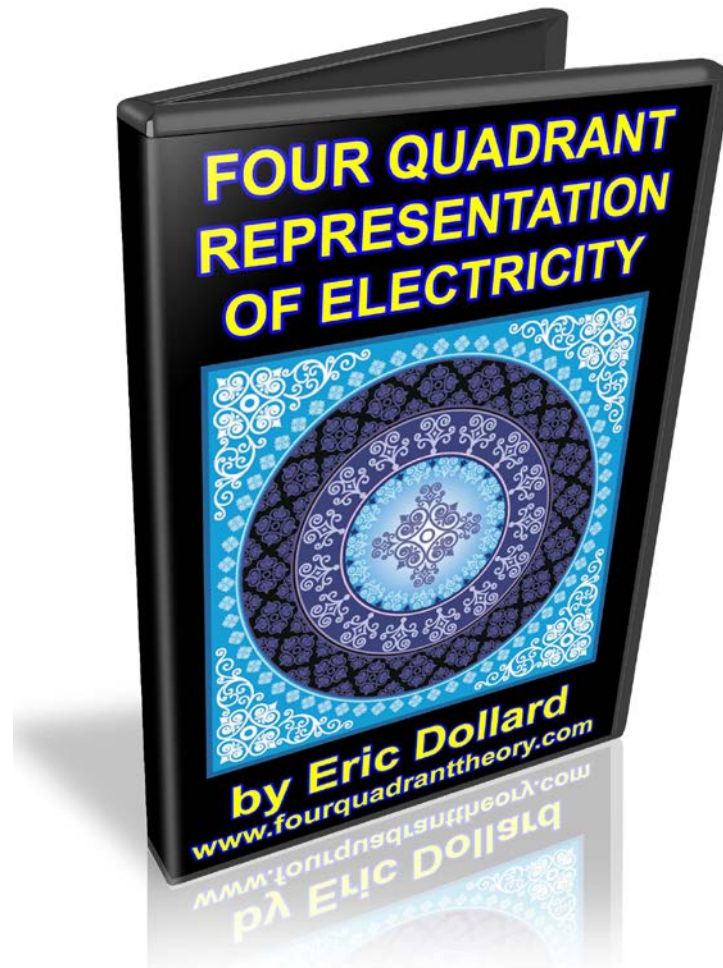

JOIN THE GROWING NUMBER OF SUPPORTERS  
FOR THE LEGENDARY WORK OF  
ERIC P. DOLLARD AT  
ERIC'S OFFICIAL HOMEPAGE  
IT'S FREE TO JOIN!

<http://>